

ICD-08335

POPULAR COMMUNICATIONS

MARCH 1986 \$1.95
\$2.50 CANADA

Scanner And Worldwide
Shortwave Broadcasts—
Latest Information

Now Incorporating

SCAN

Magazine

The Official Publication of the
Scanner Association of North America

- Eavesdropping On The Soviet Navy
- Kol Israel: A History
- Radioteletype 'Round The Clock
- Scanning The Iowa Highway Patrol
- Army MARS: VHF Giant



KENWOOD

...pacesetter in Amateur radio

Scan the World



R-2000

All-mode receiver.

- Covers 150 kHz – 30 MHz in 30 bands.
- All mode: USB, LSB, CW, AM, FM.
- Digital VFO's. 50-Hz, 500-Hz or 5-kHz steps. F. LOCK switch.
- Ten memories store frequency, band, and mode data. Each memory may be tuned as a VFO.
- Lithium batt. memory back-up.
- Memory scan.
- Programmable band scan.
- Fluorescent tube digital display of frequency (100 Hz resolution) or time.
- Dual 24-hour quartz clocks, with timer.
- Three built-in IF filters with NARROW/WIDE selector switch. (CW filter optional.)
- Squelch circuit, all mode, built-in.
- Noise blanker built-in.
- Large front mounted speaker.
- RF step attenuator. (0-10-20-30 dB.)
- AGC switch. (Slow-Fast.)
- "S" meter, with SINPO scale.
- High and low impedance antenna terminals.
- 100/120/220/240 VAC operation.
- RECORD output jack.
- Timer REMOTE output (not for AC power).
- Muting terminals.

Service manuals are available for all receivers and most accessories.
Specifications and prices subject to change without notice or obligation.



R-100C High performance receiver • 200 kHz-30 MHz in 30 bands • AM, CW, SSB • 3 IF filters • noise blanker • RF attenuator • S-meter • 120-240 VAC • muting terminals • built-in speaker • digital display/clock/timer



R-600 General coverage receiver • 150 kHz-30 MHz in 30 bands • AM, CW, SSB • IF filters • noise blanker • RF attenuator • S-meter with SINPO scale • front mounted speaker • 3 antenna inputs • 100-240 VAC operation • record jack • muting terminals • digital display

Optional accessories:

- VC-10 VHF converter for R-2000 covers 118-174 MHz
- YG-455C 500 Hz CW filter for R-2000
- HS-4 Headphones
- HS-5 Deluxe headphones
- HS-6 Lightweight headphones
- HS-7 Micro headphones
- DCK-1 DC cable kit for 13.8 VDC operation
- AL-2 Lightning and static arrester

Additional information on Kenwood all-band receivers is available from authorized dealers.

25th
Anniversary

KENWOOD

TRIO-KENWOOD COMMUNICATIONS
1111 West Walnut Street
Compton, California 90220
CIRCLE 17 ON READER SERVICE CARD

High technology doesn't get any higher!

From the minds of MASTERVOICE. Introducing Butler - In - A - Box. The worlds first environmental control system that *responds to voice commands*. The first with A.I.R. (Artificial Intelligent Recognizer); a futuristic software program which makes it a reality.

Replace pushbutton control with voice activated magic!

Butler-In-A-Box replaces old-fashioned pushbutton control systems making them obsolete. At the sound of your voice, he carries out your tasks. All you have to do is ASK! From the comfort of your favorite easy chair, up to twenty feet away.

Control all of your electronic devices at the sound of your voice.

Butler-In-A-Box puts all of your electronic devices, high tech or not, under your voice control. He will dial your phone and answer incoming calls without ever touching him. He turns your TV, stereo, heating systems and other electronic devices on and off, even dims lights. All of this instantly or at the pre-determined times you desire.

Computerized protection against intruders.

Butler-In-A-Box has a unique, built-in infrared sensor and *intrusion detection* system that guards your home and alerts you to uninvited guests. When he detects intruders, he will *speak*, and *ask* them to identify themselves. Only you can verbally command him to turn off his intrusion detection system, because he is trained to recognize only your voice. He is also capable of interfacing with your existing home security system, so it can be activated by your voice.

Speaks and understands any language.

Your Butler-In-A-Box is smart enough to call you by name and answer "intelligently" with a variety of random responses — in any language you wish! Even with an *accent*.

Easy to install and use.

Your Butler has been designed with you in mind. He's so simple to install and use you won't believe it. Complete with instructional audio cassette and easy to follow written instructions. And, *no special wiring* of your home is required.

Experience the technology of tomorrow, today! Put Butler-In-A-Box to work for you.

Order direct or send for our free brochure by just lifting a finger, (possibly for the last time), and dialing our toll-free hot-line: 1-800-O-BUTLER. (In California) 1-(714) 952-7056. Or write:

Future Systems Marketing
5067 Cumberland Drive
Cypress, CA 90630



MASTERVOICE
BUTLER IN A BOX

Future Systems Marketing — Tomorrows dreams, today's reality.

© 1985 Mastervoice, Ltd.

CIRCLE NO. 119 ON FREE INFORMATION CARD

www.americanradiohistory.com

"The Largest Dealer of Scanners in the World"



SCANNER WORLD, USA

10 New Scotland Ave., Albany, NY 12208 518/436-9606

Special SALE!

The Regency Z30

30 Channel Automatic/Programmable Scanner

Z30 FEATURES:

- 30 Channels—For full coverage and easy selection
- No Crystals Required—Your choice of over 15,000 frequencies just by pushing a raised type button on the keyboard face
- 6 Bands—Covers high and low VHF, UHF and UHF "T" plus two FM Ham Bands.
- Search or Scan—Scan frequencies you have entered or search for exciting new frequencies.
- Priority Control—Automatically overrides all other calls to listen to your favorite frequency.
- Alarm Clock—Quartz Clock with programmable alarm.
- Permanent Backup System—Memory requires no batteries. Capacitor saves frequencies entered up to one week during power outage or storage.
- Dual Level Display—Selects brightness level of green vacuum fluorescent digital display
- Channel Lockout—Skips channels not of current interest.
- Scan Delay—Lets you set a delay so that replies to calls will be heard before scanning resumes.
- Display Messages—Display flashes verbal messages to aid in programming.
- External Antenna Jack—Permits maximum reception
- External Speaker Jack—Standard connection allows use of external speaker
- AC or DC—Use at home or on the go. AC Home Power Cord Included
- Telescoping Antenna—Electronically optimized for all frequencies, included
- UL Listed/FCC Certified Assurance of quality. American made design and manufacturer, made in USA.

EXTENDED WARRANTY PROGRAM 2 EXTRA YEARS — ONLY \$25.00

Scanner World is pleased to offer extended warranty protection on your scanner purchases. For a one time charge of only \$35.00, we will provide you with 3 additional years of warranty protection after your original warranty expires. Extended warranty program is available for all types of electronics such as two-way radios, scanners, TVs, VCR, 35mm cameras, personal computers, CBs, radar detectors, stereo equipment, etc. Scanner World can offer this program to all customers, even if product was not purchased from Scanner World. All we need is a copy of your invoice showing purchase within last 30 days. For more information and rates, refer to our 1985 Winter Catalogue or drop us a note.

Suggested Factory List Price \$279.95

Scanner World Special

\$129.99

(plus \$5.50 shipping each)

REGENCY Z30

Optional Accessories:
Cigarette Lighter Plug RGMPC . \$4.95
Z Mobile Bracket — Special . . . \$5.99

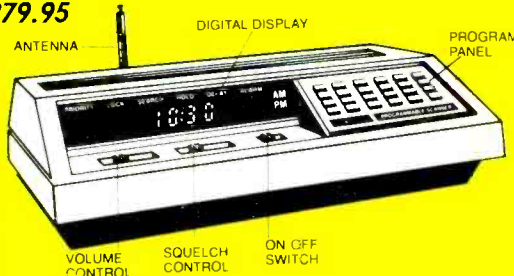

The Regency Z30 is a compact, programmable 30 channel, multi band, FM monitor receiver for use at home or on the road. It is double conversion, super heterodyne used to receive the narrow band FM communications in the amateur, public safety and business bands: 30-50, 144-174, and 440-512 MHz. Size 10 3/4" Wx2-7/8" Hx8-3/8" D.

Sophisticated microprocess-controlled circuitry eliminates the need for crystals, instead, the frequency for each channel is programmed through the numbered keyboard similar to the one used on a telephone. A "beep" acknowledges contact each time a key is touched. The Z30 scans approximately 15 channels per second.

Any combination of two to thirty channels can be scanned automatically, or the unit can be set on manual for continuous monitoring of any one channel. In addition, the search function locates unknown frequencies within a band.

Other features include scan delay, priority and a bright/dim switch to control the brightness of the 9-digit Vacuum-Fluorescent display. The Z30 can be operated on either 120 VAC or 12 VDC. Includes one year warranty from Regency Electronics (3 yr extended warranty only \$35, gives you a total of 4 yrs complete warranty), or 2 yr extended warranty only \$25, gives you a total of 3 yrs complete warranty.)

CIRCLE 57 ON FREE INFORMATION CARD

REGENCY HX1200

Digital programmable 45 channel hand-held Scanner. Frequency coverage 30-50MHz, 118-136MHz, 144-174MHz, 406-420MHz, 440-512MHz. Covers public service bands plus Aircraft. Has priority, search, lockout, scan plus much more. Package includes HX1200, AC charger/adapter, ni-cad battery, carry case, rubber antenna and 90 day factory warranty.
\$216.99 (6.50 shipping)
Complete package only.
(3 year extended warranty only \$35.00, 2 year \$25.00)

REGENCY RH-256 B

PROGRAMMABLE TRANSCEIVER

RH-256B Transceiver, 16 channel 12 VDC 2-way Radio fully programmable in transmit and receive mode. Includes built-in CTCSS tones for encode/decode, time-out timer, scan delay, 25 watts transmit power, priority, plus more. Frequency spread as shipped 152-158 MHz. Package includes mobile mike, bracket, mobile antenna, and all cables and instructions for installation. **Special package deal only: \$399.99** (7.75 shipping)
(2 year extended warranty \$49.00 — 3 year \$69.00)

Bearcat 100 XL

\$214.99 (6.50 shipping) Handheld digital programmable, no crystal portable scanner 16 channels, search feature, plus more! Frequency range: 30-50, 118-174, 406-512 MHz. Included in the package is a flexible rubber antenna, earphone, battery charger/AC adapter, 6 AA Ni-Cad rechargeable batteries and a heavy duty carry case. All for the low price of:

\$204.99 (6.50 shipping)

(3 year extended warranty only \$35.00, 2 year \$25.00)

JIL SX-200 • AC/DC

High-Low-UHF-Aircraft-16 Channel

only **\$158.99** (6.75 shipping)

Ordering Information

Call (518) 436-9606 to place orders by phone or mail orders to **Scanner World**, 10 New Scotland Ave Albany NY 12208. Orders will be shipped same day received by United Parcel Service. **Scanner World** accepts VISA, MasterCard. COD shipments by United Parcel will be for cash or certified checks only. Mail orders with personal or business checks will be held 4 weeks for bank clearance. Orders with cashiers checks or money orders shipped same day received. Prices specifications and terms subject to change without prior notice. If items are out of stock we will backorder and notify you of delivery date. All shipments are FOB **Scanner World** warehouse in Albany, NY. We are not responsible for typographical errors. All merchandise carries full manufacturers warranty. Bid Proposals and Purchase orders accepted from Government agencies. Free full line catalogue available upon request. No minimum order. New York State Residents add 7% sales tax. Dealers send business letterhead for dealer wholesale information.

SHIPPING CHARGES

(* Add \$) per scanner, and \$3.00* for all accessories ordered at same time. COD shipments will be charged an additional \$3.00 per package. Full insurance is included in shipping charges. All orders are shipped by United Parcel Service. Shipping charges are for continental USA only. Outside of continental USA, add \$15.00 per scanner.

Scanner World, USA

10 New Scotland Ave., Albany, NY 12208

(518) 436-9606

Most orders Shipped Same Day Received!

| | | |
|---|--------|---------|
| BEARCAT 50XL Programmable Hand-Held | 124.99 | (5.00) |
| AD100U AC Adapter/Charger for 50 XL | 12.95 | () |
| BEARCAT 140 AC Programmable Scanner | 94.99 | (5.00) |
| BEARCAT 145XL AC Programmable Scanner | 104.99 | (5.00) |
| BEARCAT 175XL AC Digital Scanner | 159.99 | (5.00) |
| BEARCAT 100XL Digital Hand-held (Sale) | 204.99 | (6.50) |
| BEARCAT 210XW AC/DC Digital Scanner | 214.99 | (6.50) |
| BEARCAT 5 AC Crystal Scanner | 86.99 | (4.00) |
| BEARCAT 15 AC/DC Crystal Scanner | 99.99 | (5.00) |
| BEARCAT 200 AC Digital Scanner | 172.99 | (5.00) |
| BEARCAT 20/20 AC/DC Digital Scanner | 249.99 | (5.50) |
| BEARCAT 260 AC/DC Digital Scanner | 239.99 | (6.00) |
| BEARCAT 300 AC/DC Digital Scanner | 294.99 | (7.00) |
| BEARCAT 800 XLT AC/DC Digital Scanner | 319.99 | (6.00) |
| BEARCAT DX-1000 Shortwave Receiver | 439.99 | (12.00) |
| REGENCY HX-1200 Digital Hand-held 45 Channel | 216.99 | (6.50) |
| REGENCY MA-257 Cigarette cord for HX1000/1200 | 16.99 | () |
| REGENCY MA-917 Ni-cad Battery for HX1000/1200 | 21.99 | () |
| REGENCY HX-CASE Hvy Leath. case for HX1000/1200 | 34.99 | () |
| REGENCY MA-256 Drop in charger for HX1000/1200 | 64.99 | (3.50) |
| REGENCY R-1060 Programmable 10 chan. AC Scanner | 94.99 | (5.00) |
| REGENCY HX-2000 Digital Hand-Held | 299.99 | (6.50) |
| REGENCY MX-3000 AC/DC Digital Scanner | 198.99 | (6.50) |
| REGENCY MX-4000 AC/DC Digital Scanner | 319.99 | (6.50) |
| REGENCY MX-5000 AC/DC Digital Scanner | 349.99 | (6.50) |
| REGENCY MX-7000 AC/DC Digital Scanner | 399.99 | (7.00) |
| REGENCY Z-10 AC/DC Digital Scanner | 146.99 | (5.50) |
| REGENCY Z-30 AC/DC Digital Scanner | 129.99 | (5.50) |
| REGENCY Z-45 AC/DC Digital Scanner | 179.99 | (5.00) |
| REGENCY Z-60 AC/DC Digital Scanner | 199.99 | (5.50) |
| Mobile Mounting Bracket for Z Scanner | 5.99 | () |
| REGENCY D-810 AC Digital Scanner | 175.99 | (5.50) |
| REGENCY C-403 AC Crystal Scanner | 66.99 | (4.00) |
| REGENCY ACT-R-106 AC/DC Cryst. Scanner | 96.99 | (4.50) |
| REGENCY ACT-R-1 AC/DC Cryst. Single Channel | 75.99 | (4.00) |
| REGENCY RH-256 High Band Transceiver | 399.99 | (7.75) |
| ROD MRP - Single Channel Hand-Held | 38.99 | (3.00) |
| JIL SX-200 AC/DC Digital Scanner | 158.99 | (6.75) |
| JIL SX-400 DC Digital Scanner | 479.99 | (12.00) |
| FANON MBHLU DC Crystal Scanner | 99.99 | (4.00) |
| FANON PSK-1 AC Adapted for MBHLU | 12.99 | () |
| FANON Slim-6 HLU Crystal Hand-held Scanner | 103.99 | (4.00) |
| FOX BMP-1060 AC/DC Digital Scanner | 149.99 | (5.50) |
| FOX Mounting Bracket for BMP-1060 | 9.99 | () |
| WHISTLER Spectrum Radar Detector | 199.99 | (5.00) |
| WHISTLER Remote Spectrum Radar Detector | 199.99 | (5.00) |
| ANT-1 Magnet Mount Mobile Scanner Antenna | 29.99 | (3.00) |
| ANT-6 Base Scanner Antenna w/50' cable | 29.99 | (3.00) |

Super Special Package Sale

REGENCY HX-650

Pocket Scanner

6 CHANNELS — 4 BANDS

| | |
|------------|------------------------|
| VHF-Low | 30-to 50 MHz |
| VHF-High | 146 to 174 MHz |
| UHF | 450 to 470 MHz |
| UHFT | 470 to 512 MHz |
| Small Size | 3 1/2" Wx5 1/2" Hx1" D |

Quality features included in the Regency HX-650 are 6 channels - 4 band coverage, lockout switches, manual step switch, scanning speed of 15 channels per second, long lasting LEDs, volume & squelch controls, AC adapter charger jacks.

Scanner World's Special Package Deal

Includes the following:

- Regency HX-650 Pocket Scanner
- MA-506 Carry Case
- Set of 4AAA Nickel Cadmium Batteries
- 6 Monitor Crystals (specify frequencies needed or we will include certificates for unknown frequencies)
- Flexible Rubber Duckey Antenna

Scanner World Package Price

\$109.99

(Plus \$5.50 Shipping)



EDITORIAL STAFF
Tom Kneitel, K2AES
Editor

Anita Hippius
Associate Editor

CONTRIBUTING EDITORS

Gerry L. Dexter
Shortwave Broadcast

Robert Margolis
RTTY Monitoring

Gordon West, WB6NOA
Survivalist Communications

Mike Chabak
Utility Communications

Don Schimmel
Ute Intercepts

Darren Leno, WD0EWJ
Alternative Radio

Harold A. Ort, Jr.
Military Consultant

Janice Lee
Radar Detectors

Chuck Gysi, N2DUP
Scanners

Julian Macassey, N6ARE
Telephone Accessories

Mark J. Manucy, W3GMG
AM/FM Broadcasts

Ed Noll
Antennas

BUSINESS STAFF

Richard A. Ross, K2MGA
Publisher

Herb Pressman, KA2UGV
Advertising Manager

Dorothy Kehrwieler
General Manager

Arlene Caggiano
Accounting

Cheryl Chomicki
Subscriber Services

PRODUCTION STAFF

Elizabeth Ryan
Art Director

Barbara Scully
Artist

Dorothy Kehrwieler
Production Manager

Gail M. Schieber
Production Assistant

Pat Le Blanc

Richard Kishanuk
Phototypographers

Hal Keith
Technical Illustrator

Larry Mulvehill, WB2ZPI
Contributing Photographer

Offices: 76 North Broadway, Hicksville, NY 11801. Telephone 516 681-2922. Popular Communications (ISSN 0733-3315) is published monthly by Popular Communications, Inc. Corporate officers: Richard A. Ross, Pres.; Thomas S. Kneitel, Vice Pres.; Alan M. Dorhoffer, Secretary. Second class postage paid at Hicksville, NY and additional offices. Subscription prices: Domestic—one year \$16.00, two years \$29.00, three years \$42.00. Canada/Mexico—one year \$20.00, two years \$37.00, three years \$54.00. Foreign—one year \$22.00, two years \$41.00, three years \$60.00. Foreign Air Mail—one year \$75.00, two years \$147.00, three years \$219.00. Entire contents copyright © 1986 by Popular Communications, Inc. Popular Communications assumes no responsibility for unsolicited manuscripts, photographs, or drawings. Allow six weeks for change of address or delivery of first issue. Printed in the United States of America.
Postmaster: Please send change of address to Popular Communications, 76 North Broadway, Hicksville, NY 11801.

Now Incorporating
SCAN Magazine
POPULAR COMMUNICATIONS

MARCH 1986

VOL. 4, NO.7

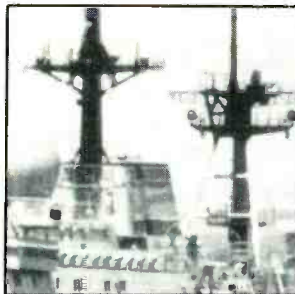

28

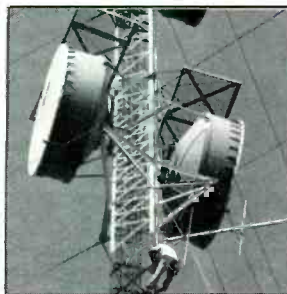

32

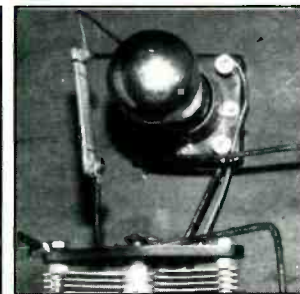

36

FEATURES

SCAN Scanning Today 8

Attention all SCAN members. Here's late news for you. *by Robert A. Hanson*

Kol Israel – Radio Encircled 10

Thirty-eight years has meant a lot. Look how it has grown! Here's where it has been and where it's heading. *by Gerry L. Dexter*

Scanning The Iowa Highway Patrol 16

The Hawkeye state's highway patrol offers interesting scanning. One more in our continuing series of communications close-ups. *by Andrew Whiting*

RTTY 'Round The Clock 18

For a change of pace, tune in RTTY at any hour! Modern technology makes it easy! If you haven't yet gotten the RTTY "bug," let us help you! *by E. R. Howard, KNJ2MX*

Remembering Radio 22

Radio communications and broadcasting in days of yore. A leisurely stroll through history to discover our roots. *by Alice Brannigan*

SCAN Photo Contest Winners 27

Send your photo in today.

SCAN Public Service Award 27

Here's a firefighter who really deserves the award.

Eavesdropping On The Soviet Navy 28

A large and active international naval presence requires a communications network of equal stature. *by Harry Caul, KIL9XL*

U.S. Army MARS: VHF Giant 32

Here's how you can monitor this large network on your scanner. *by Patrick J. Chick, N8DAQ/AAR5TO*

A One-Tube DX Dynamo! 36

MW DXing with an antique radio—it can be done! A flea market bargain gets put to the test and survives! *by Ed Noll, W3FQJ*

This month's cover: Part of the antenna farm on Mount Beacon, north of New York City. Photo by Larry Mulvehill, WB2ZPI.

DEPARTMENTS

| | | | |
|-----------------------------|----|---------------------------------------|----|
| Beaming In | 4 | Radar Reflections | 54 |
| Mailbag | 6 | On The Line | 56 |
| Books You'll Like | 35 | Pirates Den | 58 |
| Better Signals | 40 | Emergency | 60 |
| POP'COMM Products | 43 | Washington Pulse | 62 |
| Scanner Scene | 44 | Communications Confidential | 64 |
| Broadcast Topix | 46 | Listening Post | 70 |
| Satellite View | 51 | Communications Shop | 75 |
| RTTY Monitoring | 52 | | |

MADISON Electronics Supply

3621 Fannin St.
Houston, TX. 77004
Call for Quotes
1-800-231-3057

Texas Number:
1-713-520-7300



 **ICOM**



IC-R7000

Commercial quality scanning receiver 25-1300 MHz plus, keyboard entry, 99 memories, 5 tuning speeds. Call for \$\$\$

ANTENNAS

MADISON stocks antennas from most MAJOR ANTENNA MANUFACTURERS. Examples
BARKER & WILLIAMSON
TRAP DIPOLE 57.50
AMECO Receiver Preamp 59.95

ROHN TOWERS

CALL

SPECIAL - BUTTERNUT ANTENNAS

SC 3000 30 to 512 MHz SCANNER ANT 58.95
SWL DIPOLE stub-tuned low loss 2 to 30 MHz 44.95
HF6V 80, 40, 30, 20, 15 & 10 meter vertical 124.95
HF2V 80 & 40 meter vertical 124.95
ACCESSORIES IN STOCK CALL

POLICIES: MASTERCARD VISA COD

All prices FOB Houston, TX except as noted. Prices subject to change without notice, subject to prior sale. Used gear sale price refunded if not satisfied. Texas residents subject to sales tax.

PACKET MANIA

The hottest trend in radio today is packet radio. Packet is error-free communications, and involves linking a special converter called a TNC (terminal node controller) with a transceiver or receiver and your computer. With a TNC you can copy RTTY, AMTOR, code, or packet communications. Madison offers both the AEA PK-80 or the Kantronics Communicator, both priced at \$229.00, as optimum ways to get started in packet. Call for further information.

BEAMING IN

AN EDITORIAL

BY TOM KNEITEL, K2AES

As absolutely incredible as it may seem, the cellular mobile telephone (CMT) industry actually tried to get a law passed in California that looked toward making it impossible for Californians to monitor communications frequencies allocated by the FCC for CMT operations. This law, and its dangerous hidden potentials, has been discussed several times previously in our pages.

The idea was, as aptly put by the Personal Radio Steering Group, Inc. in their newsletter *Personal Radio Exchange*, because "cellular companies want to be able to claim that cellular telephone calls should be entirely private (even though they can easily be received on certain types of TV sets and VCR's, not to mention scanners!)."

When the legislation failed to get approval in California, the CMT industry trade group packed up their marbles and went to Washington to see how their brainstorm would fare. When it got into those hallowed halls, it changed from being a horrible little brat into a large and rather hideous demon.

Dubbed "The Electronic Communications Privacy Act of 1985" (H.R. 3378), it was sponsored by Rep. Robert Kastenmeier (D-Wisconsin), and Rep. Carlos Moorhead (R-California), and was presented to Congress in September. A bill with the same name and almost identical wording (S-1667) was presented to the Senate by Sen. Pat Leahy (D-Vermont).

The way this legislation is structured, it would (if eventually enacted) be so broad and all-encompassing that it would be patently illegal to monitor many of the transmissions you presently enjoy listening to on your scanner! It would cause most of the VHF/UHF communications taking place to be covered under the federal anti-wiretap laws.

The only transmissions you'd be permitted to legally monitor would be broadcasts to the general public, CB, distress calls, police and fire transmissions, Ham radio, and "walkie talkies." This is what I predicted here more than a year ago when the Cable TV industry began trying to get private individuals to stop buying and using equipment that could pick up frequencies used by MDS (microwave point-to-point TV distribution stations) operations.

This is really happening! I'm not kidding!

The scanner industry has been making a valiant effort to educate the Washington legislators so they can get a clearer picture of this proposed legislation, its implications and impact.

Hard to believe that the CMT industry, in order to promote their own commercial interests, would be so conniving as to sit back and watch this taking place without having pointed out to the Congressional people

that the proposed legislation is impractical, illogical, unnecessary, and thoroughly unenforceable.

You're saying to yourself, "If the CMT people want privacy, let them use voice scramblers rather than support such sweeping legislation that puts the onus on the general public tuned to radio frequencies owned by that public." That has already been thought of. The CMT folks, not wishing to add to the costs of their hardware by incorporating scramblers, has taken the position that such an approach isn't feasible in light of existing technology. Many might disagree with such a position.

Of course, there are other 100% off-the-wall things about all of this that may have occurred to you, such as, boaters could no longer listen to any communications not specifically directed to them on any VHF marine channel. Actually, the only channel they could legally monitor would be Channel 16, used for calling and distress. The fact is, it would be legal only to hear the distress messages, but illegal to hear any other transmissions, such as a call to another vessel. How would you adjust your transceiver to screen out non-distress calls and those calls not intended for your own vessel?

And, if you're into General Aviation, you wouldn't be able to monitor 122.8 or 122.9 MHz around small airports, or control tower, or approach control frequencies, in order to safely navigate your aircraft. Wire-tapping!

Licensed in the Business Radio Service? Special Industrial Radio Service? Maritime Service? Taxi Radio Service? Relay Press Radio Service? Auxiliary Broadcast Radio Service? In any radio service where you share a frequency (or a repeater) with other local stations? Take heed; you no longer would be legally permitted to listen to see if the frequency is in use before you begin using it yourself. *Wiretapping!*

A Ham radio operator who monitors a repeater will have to switch off his/her station when there are autopatch ('phone patch) calls going through because, even though Ham contacts aren't covered by the proposed law, the telephone calls are!

Of course, scanner owners who like to sample a variety of wares on the communications bands would also be affected by each and every one of these taboos, plus numerous others that I haven't even touched upon here.

If there is anybody out there who thinks that such a law could ever be enforced, what with millions of two-way users and scanner owners now going full blast, please be sure to let me hear from you, because I have a wonderful old bridge in Brooklyn I'd like to sell you at a very reasonable price.

Yes, I know it's hard to believe that the

CMT industry, or anybody else, could have been able to peddle such an inane concept and have it taken seriously. Obviously, there's got to be a righteous hook upon which to hang such a dark cloak. And, by golly, there is!

This hook was gleefully explained in the November 18 edition of *The Spotlight*, a weekly tabloid published in Washington, DC. They heralded Kastenmeier's proposed law as if it were what *everybody* was finally waiting for because "the federal government is up to its eyeballs in electronic surveillance of American citizens." Yup, it seems that the *maguffin* is that the law will be so broad and all-encompassing that it will effectively stop federal agencies from doing any surveillance. If you believe that the passage of this law will have any restraining effect whatsoever on surveillance, then, in addition to the bridge, you might also like to consider purchasing from me a large antique copper statue of a robbed woman, recently refurbished, and located in New York Harbor.

Well, that's supposedly the point of this proposed law, and if it also happens to slice into scanners and just about all two-way communications, *sorry 'bout that!*

Rep. Kastenmeier, whose Judiciary Subcommittee on Civil Liberties has been holding the hearings on this proposal, has apparently been revved up on the federal snooping aspect of this law and has been propelled by a full head of steam mixed with misinformation. Believe me, that's a more dangerous fuel mixture than nitro-methane! Kastenmeier's philosophy on all of this is really quite basic and super-simple: "Today we have large-scale electronic mail operations, cellular and cordless telephones, paging devices, miniaturized transmitters for radio surveillance, lightweight compact television cameras for video surveillance, and a dazzling array of digitized information networks, which were little more than concepts two decades ago . . . This array of technologies enhances the risk that our communications will be intercepted by either private parties or the government."

In a nutshell, this looks to be a classic example of the tired old tactic of using a supposedly well-intentioned motive as a red herring to draw applause while something basically insidious is being slipped through the back door. Those who spot the true core of legislation are supposed to be afraid to knock it for fear that they'll be accused of endorsing continued federal agency use of electronic surveillance. This is neither a very new nor novel way of approaching something, but it does work, like hiding the aspirin in the baby's orange juice.

And, when stripped of its padding about curbing federal surveillance, all the fuss seems to be just so the CMT industry can make more money by selling equipment without scramblers while still promising their customers "privacy."

But many people already own CMT's. The industry is selling these units as fast as they can produce them, and without any assurances of communications privacy. Lots

of cordless telephones, mobile telephones, marine and aircraft radios, business/industrial and land transportation communications equipment has also been sold and used for a very long time without the promise of privacy, and without an industry trade organization having to resort to a smokescreen about ending federal snooping.

One can but wonder about the potentials of this latest effort to slice into communications and monitoring usage. Could it also affect monitoring on the VLF or international shortwave bands, or on MDS frequencies, or elsewhere? Your guess is as good as mine. The way they're thinking now, radio astronomy might be considered to be wire-tapping! Folks who have something extraordinarily private to discuss have long been well aware that a radio circuit or even a land-line telephone can never offer complete privacy, regardless of laws supposedly giving such assurances.

Since the very earliest days of spark gap transmission, and continuing through about eight decades, communications monitoring has been a popular and honorable preoccupation with far more instances of benefit than of harm to the public. As far as I can see, all of the paranoia about the monitoring public goes back only about 5 or 6 years, when Motorola began publicizing their DVP voice scramblers. Their promotional cam-

paign suggested that scanner owners were probably as disreputable in person as they looked in the Motorola sales literature showing a posed photograph of some guys resembling my wife's uncles—Moe, Larry, and Curly.

Since that time, there seems to have been a growing suspicion about the caliber of persons involved in all types of monitoring efforts. This was demonstrated so well in Rep. Kastenmeier's statement we quoted.

Actually, it would all be quite humorous if it weren't so frightening!

Maybe now is a good time to check in with your Congressional representatives to see where they stand on the so-called Electronic Communications Privacy Act of 1985. You might like to offer some of your own opinions, just in case he doesn't fully comprehend the basic implications of the proposed legislation.

On Another Topic

We should have pointed out that the October editorial commentary about Radio Marti's programming included, in part, research done by Nelson P. Valdes of Albuquerque, New Mexico. Sorry that we neglected to mention that last October. **PC**

Public safety communications... is it too public?



The Motorola Digital Voice Protection System keeps public safety communications private.

Public safety communications are the lifeblood of our society. They are the means by which we call for help, report accidents, and coordinate emergency services. For many years, these communications have been vulnerable to interception and eavesdropping. Now, Motorola has developed a new approach to protect these vital communications. The Motorola Digital Voice Protection System (DVPS) is a revolutionary new technology that provides a high level of security for public safety communications. It uses digital voice processing to scramble the audio signal, making it impossible to intercept and understand. This system is designed to be used in a wide variety of applications, including police, fire, and ambulance communications. It is a simple, reliable, and effective way to protect your most important communications.

AA MOTOROLA
Communications and Electronics, Inc.

Communications monitors seem to have been regarded without suspicion until Motorola came up with a new approach a few years ago. Since then, others have tried to run with the ball.

MAILBAG LETTERS TO THE EDITOR

The most interesting questions we receive will be answered here in each issue. Address your questions to: Tom Kneitel, Editor, Popular Communications magazine, 76 North Broadway, Hicksville, NY 11801.

High Flyin' Weather

I'm constantly amazed by the large amount of communications traffic on the FAA Flight Watch frequency (122.0 MHz). It seems to me that with weather information being such a vital part of aviation, there would be one or two additional frequencies implemented to give weather data to pilots. It makes good listening, too! Better weather info than the NWS broadcasts.

Ben Emerson, Sr.
Springfield, MO

The FAA, like other federal agencies, is caught in the budget crunch. Further complicating the situation is the burden of pilots being required to communicate with the FAA's Flight Service Stations (which operate the Flight Watch network). This has resulted in the FAA putting a number of expansion plans into limbo—including the enlargement of the Flight Watch program. Flight Watch now operates every day on 122.0 MHz between 0600 and 2200 local time, exchanging weather information with aircraft flying at a minimum of 5,000 feet and within 80 miles of a Flight Watch transmitting facility. Aircraft below 5,000 feet can also use the service if they can achieve communications with a ground station. Hoping to relieve congestion on 122.0 MHz, last year the FAA ran a test of a second Flight Watch channel at their Oakland, Las Vegas, and Phoenix stations. This was conducted on 134.825 MHz and was intended for aircraft flying above 18,000 feet. If the service is ever expanded, that would be a possible frequency for it to use in addition to 122.0 MHz. —Editor

TV Jeebies

When is the best time to try DX'ing on a TV set? Will TV stations verify reception reports? I ask because I do notice TV "skip" coming through from time to time and it might be an interesting aspect of the DX hobby.

Justin Michaels
Canoga Park, CA

It's a wonderful aspect of the DX hobby, but you weren't the first to discover TV DX'ing. Folks have been avidly pursuing these stations for at least 40 years! Although the peak DX reception time occurs in June, you can find yourself in the midst of a DX opening during other times of the year. TV broadcasters have been quite generous with QSL's. Many TV DX enthusiasts like to take still photos or make VCR recordings of their

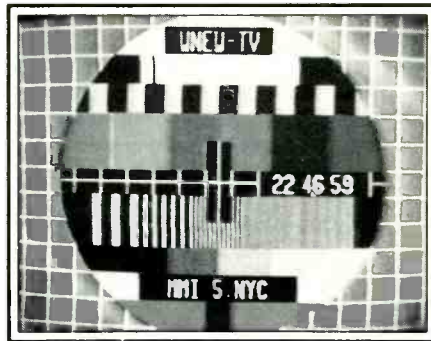

receiving accomplishments. The photo here was taken from a TV screen. While it didn't represent DX (Channel 5 in New York City is local to me), it is interesting in that it is a test pattern shown at 10:46 p.m. during evening prime time viewing hours (note the digital time shown in the photo). It was taken when the TV station was having a technical problem and points up the advantages of always keeping a camera handy for sudden DX openings or other unusual occurrences. As a side benefit, you get to feel like you're always pursuing your hobby and not simply wasting your time watching *Dynasty* or *Dallas*. —Editor

You And Your Big Mouth — Me And Mine!

In the three years I've been reading POP'COMM, I have been clued-in on many frequencies offering far-out communications. I've always thought that the DX'ing fraternity is, in many ways, similar to a gigantic intelligence gathering agency, rooting-out communications that would otherwise have remained hidden. The federal government ought to hire all of us.

W.B. Ravel
Kansas

The government's Intelligence Community is fully aware of the DX'ing hobby. For many years several agencies have pored over just about all publications (including SWL club newsletters) for whatever information of interest DX'ers have managed to discover. In that respect, they don't need to hire SWL's since they already have input from their findings. Moreover, these agencies seem to regard this information with seriousness. Not long ago, one of our authors was told by such an agency that speculations he has made in our pages about a certain type of overseas transmission were beginning to delve into areas where they would prefer he minded his own business. Apparently he was getting too close to "home plate" on a rather ticklish topic!

A reader once obtained, through the Freedom of Information Act, a large batch of paperwork relating to federal interest in SWL material that had appeared in a now-defunct electronics magazine. He sent me a

photocopy of one of a particular agency's in-house memos that offered a critique of a feature story I had written in which that agency's communications were mentioned. Although the memo had been heavily censored, and noted that I hadn't made any "specific derogatory reference" to the agency in question, the agency was less than happy that, in my article, I quoted from a letter they had sent to me. The memo ended with, "Recommendation: Inasmuch as Kneitel has demonstrated that he will publicize any communication to him, that any future dealings with him be held to an absolute minimum and then in a most circumspect fashion."

That memo, on an official federal memorandum form, is framed and hanging on my wall. It has been almost 20 years since they wrote this memo and, basically, they've lived up to its recommendations! —Editor

Vexed But Not Perplexed

This isn't *The Riddle of the Ages*, but it is a nagging question that has been the cause of some discussion between several of us interested in scanners. Given that there is inherent signal loss in coaxial cable, and given that the higher the scanner's antenna is the better it will receive, there is then the question of the possibilities that the built-in whip antenna that comes with the scanner (and requires no coaxial cable) may well offer coverage of equal quality to a rooftop antenna, which has its signals diminished by passing them through coaxial cable. And yet it is apparent that the rooftop antenna will nevertheless outperform the built-in antenna, but why?

John M. McGuire
Vancouver, Washington

As you observed, the higher the scanner antenna is, the better line-of-sight viewpoint it has to pick up stations; this ability diminishes as this height is reduced. The advantages of this height (and the fact that the rooftop antenna is outside of the building structure, especially in a building with a metal framework) more than offset the relatively small signal losses which might be encountered with the average coaxial cables used for scanners. A 25 foot run of regular RG-58A will have negligible signal loss, while a run of as long as 100 feet will show about a 5 dB loss on the VHF high band. However, long runs can have the losses minimized by the use of special low-loss cable or by the use of types such as RG-8A (having a nominal 2 dB loss per 100 feet on the VHF high band). A 100-foot high scanner antenna, even with cable losses, will be far more effective than the built-in one that comes with the scanner. However, coaxial cable doesn't get better with age, and if it becomes damaged or when it gets to be several years old, its signal loss abilities increase considerably. —Editor

NEW! Lower Price Scanners

Communications Electronics,[™] the world's largest distributor of radio scanners, introduces new lower prices to celebrate our 15th anniversary.

Regency[®] MX7000-DA

List price \$699.95/CE price \$394.95/SPECIAL
10-Band, 20 Channel • Crystalless • AC/DC
Frequency range: 25-550 MHz, continuous coverage and 800 MHz to 1.3 GHz, continuous coverage
The Regency MX7000 scanner lets you monitor military, F.B.I., Space Satellites, Police and Fire Departments, Drug Enforcement Agencies, Defense Department, Aeronautical AM band, Aero Navigation Band, Fish & Game, Immigration, Paramedics, Amateur Radio, Justice Department, State Department, plus thousands of other radio frequencies most scanners can't pick up. The Regency MX7000 is the perfect scanner for intelligence agencies that need to monitor the new 800 MHz cellular telephone band. The MX7000, now at a special price from CE.

Regency[®] Z60-DA

List price \$379.95/CE price \$179.95/SPECIAL
8-Band, 60 Channel • No-crystal scanner
Bands: 30-50, 88-108, 118-136, 144-174, 440-512 MHz
Hear Police, Aircraft and the FM Broadcast Bands. The Regency Z60 covers all the public service bands plus aircraft and FM music for a total of eight bands. The Z60 also features an alarm clock and priority control as well as AC/DC operation. Order today.

Regency[®] Z45-DA

List price \$329.95/CE price \$159.95/SPECIAL
7-Band, 45 Channel • No-crystal scanner
Bands: 30-50, 118-136, 144-174, 440-512 MHz
The Regency Z45 is very similar to the Z60 model listed above however it does not have the commercial FM broadcast band. The Z45, now at a special price from Communications Electronics Inc.

Regency[®] RH250B-DA

List price \$613.00/CE price \$329.95/SPECIAL
10 Channel • 25 Watt Transceiver • Priority
The Regency RH250B is a ten-channel VHF land mobile transceiver designed to cover any frequency between 150 to 162 MHz. Since this radio is synthesized, no expensive crystals are needed to store up to ten frequencies without battery backup. All radios come with CTCSS tone and scanning capabilities. A monitor and night/day switch is also standard. This transceiver even has a priority function. The RH250 makes an ideal radio for any police or fire department volunteer because of its low cost and high performance. A UHF version of the same radio called the RU150B covers 450-482 MHz, but the cost is \$449.00. To get technician programming instructions, order a service manual from CE with your radio system.

NEW! Bearcat[®] 50XL-DA

List price \$199.95/CE price \$114.95/SPECIAL
10-Band, 10 Channel • Handheld scanner
Bands: 29.7-54, 136-174, 406-512 MHz
The Uniden Bearcat 50XL is an economical, hand-held scanner with 10 channels covering ten frequency bands. It features a keyboard lock switch to prevent accidental entry and more. Also order part # **BP50** which is a rechargeable battery pack for \$14.95, a plug-in wall charger, part # **AD100** for \$14.95 and also order optional cigarette lighter cable part # **PS001** for \$14.95.

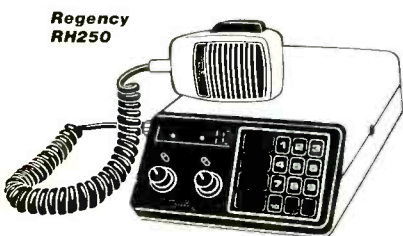

NEW! JIL SX-400-DA

List price \$799.95/CE price \$399.95/SPECIAL
Multi-Band, 20 Channel • No-crystal Scanner
Search • Lockout • Priority • AC/DC
Frequency range: 26-520 MHz, continuous coverage
With optionally equipped RF converters 150KHz, 3.7 GHz
To celebrate our 15th anniversary, when you order the JIL SX-400 synthesized scanner before March 31, 1986, from CE, you'll get your choice of the RF-8014-DA or RF-5080-DA converter **free**. Or if you prefer, you can get the RF-1030-DA converter for only \$50.00 more with your SX-400 order. The JIL SX-400 is designed for commercial and professional monitor users that demand features not found in ordinary scanners. The SX-400 will cover from 150 KHz to 3.7 GHz, with RF converters. You may also order the following RF converters for your SX-400 scanners separately at these prices: **RF-1030-DA** at \$234.95 each for frequency range 150 KHz - 30 MHz. USB, LSB, CW and AM. (CW filter required for CW signal reception). **RF-5080-DA** at \$194.95 each for 500-800 MHz. **RF-8014-DA** at \$194.95 each for 800 MHz - 1.4 GHz. Be sure to also order **ACB-300-DA** at \$99.95 each which is an antenna control box for connection of the RF converters. The **RC-4000-DA** data interface at \$259.95 each gives you control of the SX-400 scanner and RF converters through a computer. Add \$3.00 shipping for each RF converter, data interface or antenna control box. Add \$10.00 for shipping both the scanner and free converters. If you need further information on the JIL scanners, contact JIL directly at 213-926-6727 or write JIL at 17120 Edwards Road, Cerritos, California 90701.

SPECIAL! JIL SX-200-DA

List price \$499.95/CE price \$157.95/SPECIAL
Multi-Band - 16 Channel • No-Crystal Scanner
Frequency range 26-88, 108-180, 380-514 MHz
The JIL SX-200 has selectable AM/FM receiver circuits, tri-switch squelch settings - signal, audio and signal & audio, outboard AC power supply - DC at 12 volts built-in, quartz clock - bright vacuum fluorescent blue read-outs and dimmer, dual level search speeds, tri-level scan delay switches, 16 memory channels in two channels banks, receive fine tune (RIT) ± 2KHz, dual level RF gain settings - 20 db pad, AGC test points for optional signal strength meters all for this special price

NEW! Regency[®] HX1200-DA

List price \$369.95/CE price \$219.95/SPECIAL
8-Band, 45 Channel • No Crystal scanner
Search • Lockout • Priority • Scan delay
Sidelit liquid crystal display • EARMOM Memory
New Direct Channel Access Feature
Bands: 30-50, 118-136, 144-174, 406-420, 440-512 MHz
The new handheld Regency HX1200 scanner is fully keyboard programmable for the ultimate in versatility. You can scan up to 45 channels at the same time including the AM aircraft band. The LCD display is even sidelit for night use. Order **MA-256-DA** rapid charge drop-in battery charger for \$68.95 plus \$3.00 shipping/handling. Includes wall charger, carrying case, belt clip, flexible antenna and nicad battery.

NEW! Bearcat[®] 100XL-DA

List price \$349.95/CE price \$209.95/SPECIAL
9-Band, 16 Channel • Priority • Scan Delay
Search • Limit • Hold • Lockout • AC/DC
Frequency range: 30-50, 118-174, 406-512 MHz
The world's first no-crystal handheld scanner now has a LCD channel display with backlight for low light use and aircraft band coverage at the same low price. Size is 1 3/8" x 7 1/2" x 2 1/4". The Bearcat 100XL has wide frequency coverage that includes all public service bands (Low, High, UHF and "T" bands), the AM aircraft band, the 2-meter and 70 cm. amateur bands, plus military and federal government frequencies. Wow, what a scanner!

Included in our low CE price is a sturdy carrying case, earphone, battery charger/AC adapter, six AA ni-cad batteries and flexible antenna. Order your scanner now.

Bearcat[®] 210XW-DA

List price \$339.95/CE price \$209.95/SPECIAL
8-Band, 20 Channel • No-crystal scanner
Automatic Weather • Search/Scan • AC/DC
Frequency range: 30-50, 136-174, 406-512 MHz
The new Bearcat 210XW is an advanced third generation scanner with great performance at a low CE price.

NEW! Bearcat[®] 145XL-DA

List price \$179.95/CE price \$102.95/SPECIAL
10 Band, 16 channel • AC/DC • Instant Weather
Frequency range: 29-54, 136-174, 420-512 MHz
The Bearcat 145XL makes a great first scanner. Its low cost and high performance lets you hear all the action with the touch of a key. Order your scanner from CE today.



NEW! Bearcat[®] 800XLT-DA

List price \$499.95/CE price \$317.95
12-Band, 40 Channel • No-crystal scanner
Priority control • Search/Scan • AC/DC
Bands: 29-54, 118-174, 406-512, 806-912 MHz
The Uniden 800XLT receives 40 channels in two banks. Scans 15 channels per second. Size 9 1/4" x 4 1/2" x 1 1/2"

OTHER RADIOS AND ACCESSORIES

| | | |
|----------------------|---|----------|
| Panasonic RF-2600-DA | Shortwave receiver | \$179.95 |
| Panasonic RF-8300-DA | Shortwave receiver | \$195.95 |
| RD95-DA | Uniden Remote mount Radar Detector | \$128.95 |
| RD55-DA | Uniden Visor mount Radar Detector | \$98.95 |
| RD9-DA | Uniden "Passport" size Radar Detector | \$239.95 |
| BC 210XW-DA | Bearcat 20 channel scanner SALE | \$209.95 |
| BC-WA-DA | Bearcat Weather Alert [™] | \$49.95 |
| DX1000-DA | Bearcat shortwave receiver SALE | \$349.95 |
| PC22-DA | Uniden remote mount CB transceiver | \$99.95 |
| PC55-DA | Uniden mobile mount CB transceiver | \$59.95 |
| RI060-DA | Regency 10 channel scanner | \$98.95 |
| MX3000-DA | Regency 30 channel scanner | \$198.95 |
| XL156-DA | Regency 10 channel scanner SALE | \$129.95 |
| UC102-DA | Regency VHF 2 chan. 1 Watt transceiver | \$124.95 |
| RH250B-DA | Regency 10 ch 25 Watt VHF transceiver | \$329.95 |
| RH600B-DA | Regency 10 ch 60 Watt VHF transceiver | \$454.95 |
| RU150B-DA | Regency 10 channel UHF transceiver | \$449.95 |
| RPH410-DA | 10 ch handheld no-crystal transceiver | \$399.95 |
| P1405-DA | Regency 5 amp regulated power supply | \$119.95 |
| P1412-DA | Regency 12 amp regulated power supply | \$179.95 |
| BC10-DA | Battery charger for Regency RPH410 | \$79.95 |
| MA256-DA | Drop-in charger for HX1000 & HX1200 | \$68.95 |
| MA257-DA | Cigarette lighter cord for HX1200 | \$19.95 |
| MA917-DA | Ni-Cad battery pack for HX1200 | \$34.95 |
| EC10-DA | Programming tool for Regency RPH410 | \$24.95 |
| SMRH250-DA | Service man for Regency RH250 | \$24.95 |
| SMRU150-CA | Service man for Regency RU150 | \$24.95 |
| SMRPH410-DA | Service man for Regency RPH410 | \$24.95 |
| SMMX7000-DA | Service man for MX7000 & MX5000 | \$19.95 |
| SMMX3000-DA | Service man for Regency MX3000 | \$19.95 |
| B-4-DA | 1.2 V AAA Ni-Cad batteries (set of four) | \$9.00 |
| A-135C-DA | Crystal certificate | \$3.00 |
| FB-E-DA | Frequency Directory for Eastern U.S.A. | \$12.95 |
| FB-W-DA | Frequency Directory for Western U.S.A. | \$12.95 |
| TSG-DA | "Top Secret" Registry of U.S. Govt. Freq. | \$14.95 |
| TIC-DA | Techniques for Intercepting Comm. | \$14.95 |
| RRF-DA | Railroad frequency directory | \$14.95 |
| CIE-DA | Covert Intelligence. Elect. Eavesdropping | \$14.95 |
| A60-DA | Magnet mount mobile scanner antenna | \$35.00 |
| A70-DA | Base station scanner antenna | \$35.00 |
| USAMM-DA | Mag mount VHF/UHF ant. w/ 12' cable | \$39.95 |
| USAK-DA | 3/4" hole mount VHF/UHF ant. w/ 17' cable | \$35.00 |
| USATLM-DA | Trunk lip mount VHF/UHF antenna | \$35.00 |

Add \$3.00 shipping for all accessories ordered at the same time. Add \$12.00 shipping per shortwave receiver. Add \$7.00 shipping per scanner and \$3.00 per antenna.

BUY WITH CONFIDENCE

To get the fastest delivery from CE of any scanner, send or phone your order directly to our Scanner Distribution Center.[™] Michigan residents please add 4% sales tax or supply your tax I.D. number. Written purchase orders are accepted from approved government agencies and most well rated firms at a 10% surcharge for net 10 billing. All sales are subject to availability, acceptance and verification. All sales on accessories are final. Prices, terms and specifications are subject to change without notice. All prices are in U.S. dollars. Out of stock items will be placed on backorder automatically unless CE is instructed differently. A \$5.00 additional handling fee will be charged for all orders with a merchandise total under \$50.00. Shipments are F.O.B. Ann Arbor, Michigan. No COD's. Most products that we sell have a manufacturer's warranty. Free copies of warranties on these products are available prior to purchase by writing to CE. Non-certified checks require bank clearance.

Mail orders to: Communications Electronics,[™] Box 1045, Ann Arbor, Michigan 48106 U.S.A. Add \$7.00 per scanner for U.P.S. ground shipping and handling in the continental U.S.A. For Canada, Puerto Rico, Hawaii, Alaska, or APO/FPO delivery, shipping charges are three times continental U.S. rates. If you have a Visa or Master Card, you may call and place a credit card order. Order toll-free in the U.S. Dial 800-USA-SCAN. In Canada, order toll-free by calling 800-221-3475. Telex CE anytime, dial 810-223-2422. If you are outside the U.S. or in Michigan dial 313-973-8888. Order today.

Scanner Distribution Center[™] and CE logos are trademarks of Communications Electronics Inc.
† Bearcat is a registered trademark of Uniden Corporation.
‡ Regency is a registered trademark of Regency Electronics Inc.
AD #021586-DA

Copyright © 1986 Communications Electronics Inc.

For credit card orders call 1-800-USA-SCAN

COMMUNICATIONS ELECTRONICS INC.

Consumer Products Division
P.O. Box 1045 □ Ann Arbor, Michigan 48106-1045 U.S.A.
Call 800-USA-SCAN or outside U.S.A. 313-973-8888

OFFICIAL NEWS COLUMN OF THE SCANNER ASSOCIATION OF NORTH AMERICA

"Cellwars" Continues!

Some companies in the cellular phone business continue to press for a radical change in our laws that permit unrestricted use of radio receivers in this country. The U.S. House Judiciary Committee has not even allowed testimony from scanner radio users, claiming they haven't received any significant public opposition to the proposed law! It's time to make sure they hear from us through our elected officials who will listen.

When you read how these companies want to take away your right to use a radio receiver, your first reaction may be disbelief. I know that my first reaction was that this legislation was so outlandish that it couldn't possibly happen. Even SCAN's attorney, after reading the draft legislation, thought we had nothing to worry about. The only logical interpretation of the language in the Bill was that since all "readily accessible" radio signals were exempt, there would be no problems for radio hobbyists. But wait! At the first public hearing on the Bill it was clear that the legislation sponsors and the Cellular Telephone Industry Association believe that it will take away your right to receive their frequencies, even though cellular phones aren't mentioned in the legislation. And that is the core of the problem . . .

If it is really true that non-encoded radio signals, using conventional FM transmission and dispersed widely through the airwaves, are to be defined as "not readily accessible," then what is accessible? Surely the new 800-900 MHz police, fire, business, and even Ham radio assignments are no more "readily accessible" than those cellular radio telephone transmissions. So what will be restricted? The staff of the U.S. House Judiciary Committee has refused our requests for a definition of "readily accessible." When they finally do define it, perhaps at the very last moment when the legislation is ready for a vote, we may find our right to receive anything other than broadcast stations and a few other exemptions, such as Amateur Radio and CB, has been stripped away!

How can a business with fewer than 250,000 customers impose their unreasonable demands on millions of citizens (over 9% of all U.S. households at last count) who use scanner radios? The answer is that they can't if we speak up. Now is the time to write or call your U.S. Representative about House Bill HR-3378 and your U.S. Senator about Senate Bill S-1667. Don't underestimate the power of your postcard or letter! Because so few people do write, most legislators consider that each letter represents the opinion of at least 50 to 100 people. Your opinion will be listened to!

When writing or calling about HR-3378 and S-1667 (named the "Electronic Communications Privacy Act of 1985"), it is important to remember that there are many good and important portions of the legislation that you are probably not opposed to. For instance, it is designed to protect electronic mail and computer data banks from computer "hackers" and industrial spies. What we need to point out is that the cellular telephone industry, which has hoodwinked a technologically innocent House Judiciary staff, is trying to legislate privacy for something that is inherently not private.

By trying to make it illegal to receive ordinary open FM transmissions, widely dispersed through the airwaves, this legislation will infringe on a very important right American citizens have enjoyed since the Communications Act of 1934 was enacted. Don't let this unwise and warped concept become law . . . write a letter or postcard today. Ask your U.S. Representative or Senator to demand a clear explanation of what "readily accessible" means in this legislation. They can prevent this legislation from becoming law in its present form if you will take a moment and let them know about it. If you can, please send us a copy of your letter . . . but by all means, *write!*

Frequency Update In Process

SCAN maintains the most complete and accurate frequency records in the country. Even government agencies rely on our information because FCC records reflect authorizations, not actual use. The 800-900 MHz frequencies are a prime example. Many public safety agencies are licensed but are not using the frequencies because budget approval for a new system wasn't obtained or the system is still under construction. There's no way to know for sure unless you listen . . . and that's exactly what our volunteer frequency update project people do. Once this exhaustive update is complete we'll be telling you how you can obtain the information for your area. Incidentally, some scanner owners believe that when their local police department makes the move to 800 MHz it is to make it difficult for citizens to listen in. Actually, that is rarely the case. In fact, both the International Association of Chiefs of Police and the National Sheriffs' Association are on record as endorsing the use of scanners by citizens. They realize that having the support and extra eyes and ears of local scanner users far outweighs any problems of scanner use by criminals, who would find a way to listen-in in any case. The most common reason for the move to 800 is overcrowded channels. Instead of sharing a frequency with several neighboring towns, the new band may allow exclusive use and even separate channels for traffic control and detectives. The focus of most law enforcement officials today is to include citizens in the crime prevention process—not exclude them.

Public Service Award Nominations Open

Often, scanner radio users are the first to know about the brave actions of local police, fire, EMT, and other public safety personnel who put their own lives on the line for others. The Scanner Association of North America has, since its very beginning, honored those individuals through our Public Service Award program. It's easy to make a nomination. Often a local newspaper clipping will give us all the details we need. If your nomination is selected you will not only have the satisfaction of bringing nationwide recognition to a deserving public servant, but you will also be recognized yourself with a handsome award plaque. The award winner will receive a cash award from SCAN along with a special engraved plaque. Send your nomination to SCAN Public Service Award, P.O. Box 414, Western Springs, IL 60558.

LISTEN FOR LESS



DISCOUNTS FROM EGE
Your Center for Personal Communication

SHORTWAVE LISTENING



R-7000 Intro Special - Call



R71A Limited Quantities 599.95
General Coverage Receiver

- FL-44A filter 149.00
- FL-63 CW filter 45.00
- RC-11 Remote Control 55.00
- EX-310 Voice Synth 36.00
(Accessories installed free when purchased with radio.)

Extended warranty 59.95
(Includes all labor for one year and parts for the first 6 months on an R-71A purchased at EGE.)

KENWOOD



March Super Specials

- R-2000** general coverage Call
 - R-1000** high performance Call
 - R-600** general coverage Call
- Extended Warranties available on Kenwood — Please Call

YAESU



- FRG-8800** Receiver 510.00
The newest CAT technology
- FRG 9600** Scanner 469.95
60 MHz-905 MHz, All-mode

SCANNERS



- SONY**
- ICF-2002 Compact 199.95
 - ICF-2010 Receiver 279.95
 - ICF-4910 Receiver 89.95



- PANASONIC**
- RF-3100 Receiver 268.00
 - RFB-300 Receiver 194.95



- BEARCAT**
- DX1000 Receiver 349.95

Regency

NEW HX1200 Handheld Scanner
45 ch + Aircraft Intro price **\$209.95**

- Z60 60-channel 199.95
- Z45 45-channel 169.95
- XL156 Programmable 129.95
- HX2000 handheld 239.95
- MX4000 mobile 289.00
- R1060 10-ch, 6-band 99.95
- MX3000 30-ch, 6-band 199.00
- MX5000 25-512 MHz 349.95
- MX7000 25 MHz-1.2GHz 399.00

Bearcat

- 145XL 16 ch, 10-band 99.95
- 175XL 16 ch/aircraft 154.95
- 50XL 10 ch Handheld 120.00
- 100XL 16 ch Handheld 199.95
- 800XLT 40 ch 800 MHz 319.00
- 210XW 16 ch 219.00

ANTENNAS

- SONY AN1** active antenna 79.95
- MFJ 1024** outdoor 113.00
- MFJ 1020** indoor 75.00

INTERFACES

- DECODING MORSE & RTTY**
- AEA SWLText** C-64 83.95
 - AEA CP1** Interface 229.95
 - MFJ 1225** read only 65.00
 - Kantronics** Interface II 210.95

We carry a complete collection of teletype frequency guides Call Packet by AEA & Kantronics Call

SWL BOOKS

- Full selection in stock Call
- World Radio-TV Handbook**
An additional \$2.00 off the new 1986 version when purchased with an SWL Receiver

uniden®

- RADAR DETECTORS**
- RD 55 Special 99.95
 - RD 95 remote Special 129.95
 - RD 35 Special 79.95

- 40-CHANNEL CBs**
- PC-33 AM 41.00
 - PC-55 AM 59.95
 - PC-66 AM 79.95
 - PC-77 AM 99.95
 - PC-244 mobile SSB/AM 129.95
 - Grant SSB/AM 159.95
 - Washington base 189.95
 - Zach Taylor AM base 129.95

- COBRA CBs/Radar Detectors** Call
- MIDLAND CBs** Call
- WHISTLER Radar Detectors** Call

ege, inc.

13646 Jefferson Davis Highway
Woodbridge, Virginia 22191
Information & Service: (703) 643-1063

Store Hours: MTT: 10 a.m. — 6 p.m.
WF: 10 a.m. — 8 p.m.
Sat: 10 a.m. — 4 p.m.

Order Hours: M-F 9 a.m. - 7 p.m.
Sat 10 a.m. - 4 p.m.

New Buyer's Guide-Catalog Now Available - Send \$1 Dealer Inquiries Invited



Terms: No personal checks accepted. Prices do not include shipping. UPS COD fee: \$2.35 per package. Prices are subject to change without notice or obligation. Products are not sold for evaluation. Authorized returns subject to a 15% restocking and handling fee and credit will be issued for use on your next purchase. EGE supports the manufacturers' warranties. To get a copy of a warranty prior to purchase, call customer service at (703) 643-1063. It will be furnished at no cost.

WE ALSO CARRY

- AMATEUR RADIOS**
- TOWERS & ANTENNAS**
- MARINE RADIOS**
- COMMERCIAL LAND MOBILE ACCESSORIES**

For all your needs please call

SPECIAL OFFER

- TELEX HEADPHONES**
- Procom 450 padded 35.50
 - Procom 460 padded 37.20
 - HMC-2 underchin 12.68
 - SWL-610 light weight 8.75
- BIG DISCOUNTS**

Hard to get through on our 800 number?

Call before 10 a.m. or after 5 p.m. ET, or call one of our regular numbers. If you pay for the call and order, we'll credit your order with \$1.

Ask about our **NEW SERVICE DEPARTMENT**
In-store repairs on major brands

ege, inc.

For Orders and Quotes Call Toll Free: 800-336-4799
Virginia Orders and Quotes Call Toll Free: 800-572-4201

CIRCLE 141 ON READER SERVICE CARD

Kol Israel – Radio Encircled

*Thirty Eight Years Has Meant A Lot.
Look How It Has Grown.*

BY GERRY L. DEXTER

Some of the first words ever to be broadcast by Kol Israel were those from Prime Minister David Ben Gurion as he proclaimed the birth of the State of Israel on May 14, 1948. That broadcast was carried live by Kol Israel, from the Tel Aviv Municipal Museum. The date, then, marks both the birth of a nation and the birth of a radio service.

But in the case of Kol Israel it wasn't a matter of rushing to get towers up and transmitters tuned in time. Everything was already there and May 14 marked little more than a change in the broadcaster's name, a new format, and probably a somewhat revised list of personnel.

Broadcasts from what the day before had been Palestine, had been going on since the inauguration of the Palestine Broadcasting Service on March 10, 1936. Also known as the Voice of Jerusalem, the service was established under the British mandate that ruled Palestine. Initial broadcasting was in Hebrew, Arabic, and English, but the service soon expanded in size and scope once World War II broke out.

Many of those working on the Palestine Broadcasting Service's Hebrew staff also worked in radio during their off hours. But it was radio of quite a different kind. They were secretly active on behalf of the clandestine radio stations being operated by the resistance, helping broadcast the call for an independent Jewish state and an end to British rule in the area. These broadcasters were to become the core of the new official Israeli radio.

The new station broadcast, under the auspices of the Ministry of the Interior, but was soon transferred to the Prime Minister's office. At the time it was thought important that domestic and external broadcasting be separately run and controlled, and so the fledgling foreign service, known then as the Voice of Zion to the Diaspora (the scattered Jewish community), received its funds from the Jewish Agency.

Israel was surrounded by enemy states and the thought seems to have been to be able to tell the home audience one thing and the foreign audience something else—or at least take different slants or emphasis when necessary. But with such short distances between borders both home service and foreign service programs could be heard in



An announcer in the Kol Israel studios.

other countries and the practice of making two voices speak for one nation created concern and confusion. Eventually, things were changed.

Israeli broadcasting today is considerably more developed than it was when it aired its first broadcast. What was the Israel Broadcasting Service became the Israel Broadcasting Authority in 1965 and took the external service under its wing. The arrangement was modeled to some degree after the independent system under which the BBC operates.

The IBA is charged with reflecting "Israel's life, struggle and aspirations to the audience at home as well as abroad, especially in the Jewish diaspora."

The IBA is administered by a plenum of 31 members, who are appointed by the President. Thirty of these are on government recommendation, the 31st on the recommendation of the Jewish Agency. In addition there is a seven member Board of Governors. The plenary shapes general policy while the board oversees the more day-to-day business. Both are constructed to include a wide spectrum of political views, and neither group is subject to government control. The IBA's annual budget and the amount of the yearly license fee Israeli citizens must pay on their receivers is set by the Knesset.

License fees provide about two-thirds of the IBA's operating funds. The remainder comes from radio and TV commercials and treasury grants.

The IBA is headed by a Director General who serves a term of five years. He is appointed by the government after consultation with the plenary and reports to the Board of Governors.

IBA's radio half is organized into seven divisions, covering news and current affairs, spoken word programs, classical music, entertainment and light music, external broadcasts and broadcasts for new immigrants, engineering and production, and administration. Total staff for both radio and television is about 1,600.

The news department, in addition to its own domestic staff, has a few overseas reporters and stringers. Otherwise, it relies on the official Israeli press agency ITIM and international news agencies. The IBA charter notes that "information broadcast must be reliable and provide opportunity for the expression of diverse outlooks and opinions."

There are several radio networks. Network A operates from 6 a.m. to 1 a.m. and carries what might be termed "stuffed shirt" material. Programs are on current issues of the day, and there are feature discussions on social issues, as well as Jewish songs and classical music. Two and a half hours of pro-



A recent Kol Israel QSL card.

grams for new immigrants are aired daily in Yiddish, Russian, Spanish, and English.

Network A is carried over a 200 kilowatt transmitter from Tel Aviv on 576 kiloHertz, as well as on a 10 kilowatt station in Jerusalem on 1,140 kHz and a 1 kw station in Eilat on 1,458 kHz.

Network B features news, sports, and variety. Several news magazines and documentaries are aired each day during the 6 a.m. to 1 a.m. schedule. There are features on the economy, law, even parliamentary debates.

The flagship for Network B is a 200 kilowatt station in Jerusalem on 657 kiloHertz. Other outlets carrying the service are Safad on 846 kHz with 5 kilowatts, Bet Hillel on 882 kHz with 1 kw, Eilat on 927 with 1 kw, Jerusalem with 1 kw on 1,085, 50 kilowatts from Haifa on 1,206, and several low power FM outlets.

Network B can also be heard on shortwave. Programs are all Hebrew and run from 0400 to 2315 daily. The current schedule is:

- 0400-0615 on 11.585, 9.920, 9.385
- 0400-1400 on 13.720
- 0615-1400 on 17.755
- 0615-1745 on 15.615
- 0615-1100 on 17.630
- 1100-1630 on 15.100
- 1200-1400 on 7.630
- 1830-2315 on 13.720, 11.585, 9.920

Note that, on shortwave, there is a break between 1745 and 1830. Listen for mention of "reshet bet" (Network B) during IDs.

Network C began in 1966 as a youth-orientated popular music program. It has expanded over the years so that its format is now aimed at all age groups and carries a mixture of Israeli pops, jazz, rock, and world pop music during its 6 a.m. to 1 a.m. schedule. Both network C and B carry commercials. Network C is aired over a 200 kilowatt station in Jerusalem on 531 kiloHertz.

Network D is the Arabic service, which broadcasts both to Israel's Arab citizens and to the Arab world surrounding Israel. It was funded by the Foreign Ministry during its early years and reportedly also took some direction from Israeli Military Intelligence.

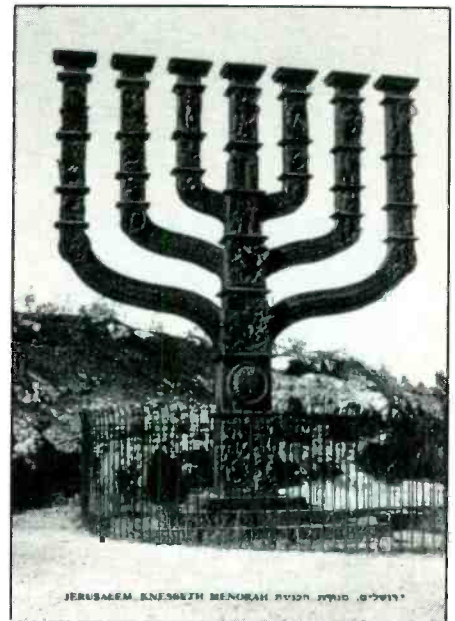

An earlier and more decorative QSL card.

Broadcasts now run for 18 hours per day and feature 11 news bulletins and three commentaries each day, the latter running under the overall title of "Advancing of Peace and Understanding." Programs concerned with art, science, literature, technology, the economy, and law are also broadcast. The network also boasts its own orchestra.

The Arab service is widely listened to outside of Israel, in large part because listeners have come to rely on it for uncolored news. They often hear the news faster than on their own state-run broadcast systems. Both are especially true during times of crisis when a portion of the Arab audience might be directly affected. During Israel's invasion of Lebanon, for example, Arab-speaking citizens of that country kept a close ear on the Arab service so they'd know where the Israeli tanks were. The service occasionally carries military or government announcements having a direct bearing on listeners to

kol israel

israel radio international

Kol Israel, External Services
P.O. Box 1082
91010 Jerusalem
Israel

**D 84 shortwave
programme schedule
4 Nov. 1984 — 3 Mar. 1985**



ELTVALTVAI

ISRAEL'S LINK TO THE DIASPORA הגשר לתפוצות ישראל

Distributed in cooperation with the Information Department W Z O

A Kol Israel program schedule.

the service in a crisis. The Arab service has also aired prisoner of war messages from captured Arab soldiers. The network gets about 100 letters a day from listeners in the Arab world.

Facilities for Network D include a full-throated 1,200 kilowatt at Jerusalem on 738 kiloHertz and a 20 kilowatt transmitter on 675, also in Jerusalem.

Network D is aired on shortwave, beamed to Europe and the Middle East on 5.915 MHz from 0400 to 2215.

Flip on an FM radio in Israel and one can escape from the news and talk and simply enjoy music in stereo over the Voice of Music network, which operates over two dozen transmitters scattered in ten cities throughout the country. Transmitter powers run from as little as 100 watts up to 40 kilowatts. The Jerusalem Symphony Orchestra is part of this network.

Television came to Israel in 1968, and 90% of Israeli homes now have TV sets. There is only one TV network (which went to all-color programming in 1983) and it shares time with a service for schools. The Instructional TV Service operates during the

daytime under the Ministry of Education. It was originally set up by the Rothschild Foundation, which ran it on a test basis before turning it over to the government.

Once school is out, it's the IBA's turn. The evening begins at 5:30 p.m. with an hour of children's programming. That's followed by an hour and a half of programs in Arabic. The evening concludes with four hours of variety, ranging from documentaries to entertainment. About half of the programs are IBA-produced and the other half imported from the U.S. and Europe with Hebrew or Arabic sub-titles added. There are nearly 20 transmitters operating on several channels, all carrying the one network. IBA-TV operates from three studios and has a fleet of five mobile units.

There's another radio network—Network E. We know it as Kol Israel or the Voice of Israel, the IBA external service.

Kol Israel operates around the clock, broadcasting in 15 different languages. These include an assortment of tongues not often heard on other stations, including Mograbi, Ladino, Bikharian, and Georgian. There's also English of course, and French,

Hebrew, Spanish, Portuguese, Persian, Yiddish, Hungarian, Romanian, and Arabic, and what might be a distant relative of VOA Special English—"Easy Hebrew."

The use of lesser-known languages and the seven hours per day beamed to the Soviet Union reflect Kol Israel's commitment to broadcasts for the diaspora and its need to reach Soviet Jewry.

Other transmissions are beamed to North America, Europe, the Middle East, Southeast Asia, the Pacific, Africa, and Latin America. Transmitting facilities for all IBA outlets are owned and operated by the Ministry of Communications. On shortwave there are about 15 transmitters, ranging in power from 20 to 300 kilowatts.

Programs in English for North America are currently scheduled at 0000-0030 on 9.815, 9.435, and 7.410; 0100-0125 on the same frequencies; and 0200-0225 on 5.900, 7.410, and 9.435.

Other English, including some with North America as a partial target area, include: 0500-0515 on 9.009, 9.435, 9.815, 11.655, 12.080, and 17.630; 1100-1130 on 11.605, 15.425, 15.560, 15.645, 17.630, and 17.815; 1800-1815 on 9.920, 11.585, and 13.720; 2000-2030 on 7.410, 9.009, 9.435, 11.605, 11.655, and 12.080; and 2230-2300 on 7.410, 9.435, 11.605, 11.655, 12.025, and 12.080.

Why the use of so many out of band channels? Ben Dalfen, editor of Kol Israel's "DX Corner" program, noted in a 1976 article in NASWA's *Frendx* bulletin that there were a number of unused channels in the areas outside the official shortwave bands and Kol Israel makes use of them to avoid interference. Larry Magne, a consultant to IBA at that time, noted that International Telecommunications Union regulations permit such out of band operations so long as other users with a greater right to the channels don't file an interference complaint within a specified period.

Frequency schedules are issued quarterly by the IBA and can be had free of charge by sending a year's worth of self-addressed stick-on mailing labels to Kol Israel External Service, P.O. Box 1082, Jerusalem. That address applies to reception reports as well.

There is one other Israeli broadcaster: the Israeli Defense Forces Station, Galei Zahal, which operates in Hebrew 24 hours per day. Broadcasts are carried over transmitters in seven Israeli cities, ranging in power from 1 to 100 kilowatts. On very rare occasions, Galei Zahal has made brief appearances on shortwave as well. However, the last known instance was in May, 1981. Whether it ever happens again is anyone's guess.

There may, however, be other things to hear on shortwave from Israel in the future. One day that country may sport a Voice of America relay station.

In the meantime, Israel offers you news of the Middle East, some seldom heard languages, odd-ball frequencies, and more to hear than simply the English language beam to North America. **PC**

MISSING



NAME: Daniel Metzger DOB: 10/6/80 Age: 5 EYES: Brown HAIR: Brown DATE MISSING: 6/14/84 FROM: Latham, IL. CHILD FIND #2354P



NAME: Stewart Wade Beam DOB: 2/28/78 Age: 7 EYES: Blue HAIR: Blonde DATE MISSING: 11/25/81 FROM: Gallatin, IL. CHILD FIND #2371P

If you can assist in identifying a child or if you are one of these missing children, call Child Find Inc.,

TOLL FREE HOTLINE (800)-I-AM-LOST

(914-255-1848 collect in NY). Please refer to the Child Find # when calling.

RECEIVING ACCESSORIES

CONVERTERS



WIRED AND TESTED TO YOUR FREQUENCY

- VLF — 30-500 KHz \$39.95
- AIRCRAFT — 108-136 Mhz \$49.95
- PUBLIC SERVICE — 150-170 Mhz \$49.95
- AMATEUR — 144-148 Mhz \$49.95

*Indicate 14 Mhz or 28 Mhz receiving range
VLF converter normally 3.5-4 Mhz output

DX ANTENNA TUNER



- EFFECTIVELY INCREASES THE LENGTH OF YOUR ANTENNA
- PROVIDES A BETTER MATCH BETWEEN ANTENNA AND RECEIVER

KIT — \$19.95
WIRED AND TESTED \$29.95

MORNING DISTRIBUTING CO.

P.O. BOX 717, HIALEAH, FLORIDA 33011

PHONE: (305) 884-8686

SEND FOR OUR NEW BROCHURE ON HOBBY KITS!

BUILD RECEIVERS, TRANSMITTERS
TRANSCIEVERS
Send For Hobby Kit Brochure

CIRCLE 90 ON READER SERVICE CARD
Add \$2.50 Shipping and Handling



®

"Stripes of Quality"

the antenna specialists co.

Base Antennas

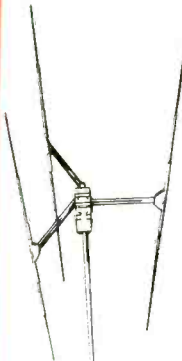

MS119 "Super Scanner"

- 5.75 dB gain in the omni-mode.
- Tremendous 8.75 dB gain as a beam...like increasing your power by more than 7 times!
- Select omni or beam direction instantly with electronic, beautifully styled desk top control (furnished).
- Eliminates slow, expensive mechanical antenna rotator.
- Search with omni...zero in with beam.



AV-801 Astro Scan™ Tri-Band Monitor

- Multiply your scanner power on the Low (25-50 MHz), VHF (140-174 MHz) and UHF (450-512 MHz) bands with this patented higher performance monitor antenna. Co-inductive 5/8 wave design for low band; full 1/2 wave dipole design for high band; and 1 1/2 wave collinear design for UHF. Easy to install, weighs only 2.25 lbs. Mounting mast and cable not included.



M-344 Magnum-44

- The safest Magnum antenna ever.
- Safety through isolation not insulation. Exclusive isolation* approach electrically decouples the radiator from the mounting system. Provides optimum CB performance and gain while isolating the radiator from the mast and coax at 60 Hz. Low-loss metal radiator with double molded encapsulated isolation system for long life and trouble-free operation.

Base Antennas

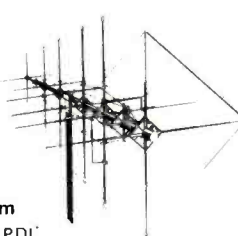

AV-146 Moonraker® 6 6-Dual Element Beam

- 6 dual elements with PDL reflector.
- 31'5" boom.

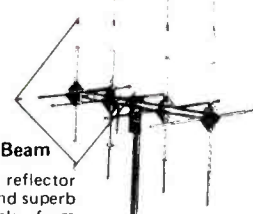

AV-140 Moonraker® 4 4-Dual Element Beam

- Uses PDL type reflector for increased gain and superb rejection of signals from unwanted directions.
- Exceptionally low VSWR across all 40 channels.

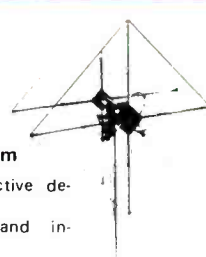

AV-122 PDL II™ Dual Polarity Beam

- Patented co-inductive design.
- Increased gain and improved band width.
- Durable but lightweight.
- Easily turned by medium-duty rotor.

Magnetic Mounts



M-710 Formula-1

- Precision-wound, water-proof "Big Momma" type coil runs cool even at higher power levels. Unconditionally guaranteed for life against burn-out. Precision-wound 12 gauge copper coil, silver plated contacts.
- A/S exclusive Quick Grip™ trunk lip mount assembly. No holes to drill, cable completely concealed.



M-711 Formula-1 Magnet Mount

- Precision-wound, water-proof "Big Momma" type coil runs cool even at higher power levels. Unconditionally guaranteed for life against burn-out. Precision-wound 12 gauge copper coil, silver-plated contacts.
- 3 1/2" diameter ceramic magnet holds securely on metallic surfaces beyond legal speeds.
- New quarter turn quick-disconnect Polycarbonate cam coupling assembly—life cycle tested over 2,500 times.

Trunk Lid Mounts



AV-261M Magnet Mount

AV-261 Permanent Mount

AV-261T No-Hole Trunk Mount

AV-251M



Roof Mounts

2-WAY

Mirror Mounts

VHF and CB Marine Antennas

Accessories

Monitor Antennas

Call us FREE 1-800-626-6343



or write for FREE Flyer.

COPPER ELECTRONICS

4200 PRODUCE ROAD

LOUISVILLE, KENTUCKY 40218

CIRCLE 155 ON READER SERVICE CARD

SHORTWAVE HEADQUARTERS

Our 15th year
Buy with confidence
Order Toll Free 800-368-3270

Technical Information and Va. Orders: (703) 938-3350

EEB - THE NATIONS LEADING SWL SUPPLIER

KENWOOD SALE



Kenwood offers 3 fine communication receivers to suit your listening pleasures. They cover the full spectrum: Long, Medium and Shortwave. AM-CW-SSB (FM R-2000), Wide-Narrow Selectivity, Noise Blanking and more.

R-600 Special Sale \$299.95
R-1000 Special Sale \$369.95
R-2000 Special Sale \$439.95
VHF Converter (R2000) \$134.95

FREE EEB will extend your warranty from 3 to 6 months. EEB is a Kenwood Factory Authorized Service Center.

SONY SALE

SONY ICF 2010 SAVE \$110.00

- 150 KHz to 30 MHz AM, CW, SSB
- 76 MHz to 108 MHz FM
- 116 MHz to 136 MHz AM Air Band
- 32 Programmable Memories
- 4 Event Timer
- Synchronous Detector
- Wide/Narrow Bandwidth



"This is one of the finest receivers available today under \$500"

A.C. Adapter included no charge.
LIST \$399.95 SALE \$289.95 + \$6.00 UPS

SONY ICF 2002 SAVE \$80.00

- Ultimate compact HiTech at an affordable price
- 25% size of famous SONY ICF 2001. SONY's best seller
- 150 kHz - 30 MHz
- AM, FM
- Memories
- Keyboard entry
- Scan
- 24 hour clock



A.C. Adapter AC9W \$14.95
LIST \$299.95 SALE \$219.95 + 4.00 UPS

SONY ICF 4910 SAVE \$30.00

- Ultra small pocket size
- AM, FM, 7 SW most popular bands—13, 16, 19, 25, 31, 41, 49 meters
- Safety Lock
- Batteries (2) AA not included

• Optional AC power
• Sale \$99.95

A.C. Adapter AC39 \$14.95
LIST \$129.95 SALE \$99.95 + \$4.00 UPS

JIL SCANNERS

JIL SX-200 SAVE \$120.00

- Commercial Rated AM/FM Scanner
- Extra-Wide Coverage 26-88, 108-180, 380-514 MHz
- CB-PSB-HAM-AIRBAND - Military-2 Way



SX400 SALE \$499.95
FREE Converter (Your Choice)
Save Over \$350!

Super Winter Sale

- SX 400 26-520 MHz
- RF 1030 100 kHz - 30 MHz Up Converter
- RF5080 500-800 MHz Down Converter
- RF8014 800-1400 MHz Down Converter
- ACB 300 Antenna Control Box
- P-1A Power Supply SX-400 & RF 1030 for A.C. Op
- RC-4000 Computer Control for NEC-8801 only
- Nothing else like this system 100 KHz to 1400 MHz.

C
A
L
L

AEA CP-1 Computer Patch



SWL Test Software and your Commodore C-64 will turn your Communications Receiver into a CW/RTTY intercept station.

- Determines RTTY Speed and ASCII or Baudot Indication
- Copies AMTOR-ARQ-FEC
- Determines Bit Inversion and Transposition Patterns.
- Complete Printer Control
- Copies Russian RTTY-Japanese RTTY & CW
- We checked them all. This is the best.

LIST \$329.90 PACKAGE DEAL \$269.95

World Radio TV Handbook New 1986 Edition



- Shortwave Listener's Bib
- All Worldwide SW Stations listed
- Schedules and Language
- Target Areas
- Equipment Reviews
- Every SWLer Needs One.

ORDER TODAY \$19.50 Post Paid US.

ANTENNAS

ARCOMM AP-4 \$89.95 + \$4.00 UPS
Free A.C. Adapter

- Tuned active indoor antenna
- 54-32 MHz - 4 inputs - 2 outputs
- Improves RF Selectivity Image Response

SONY AN-1 \$79.95 + \$6.00 UPS
A.C. Adapter \$9.95

- Outdoor active antenna
- Pull in hard to capture signals
- Perfect for SWL where no outdoor antennas allowed.

EAVESDROPPER SALE
\$59.95 + \$4.00 UPS

- Balanced trapped Dipole
- Maximum performance, Minimum local noise
- All SW Bands 60-11 Meters
- Only 43 feet long - 100 Ft. feed line
- Complete - Everything you need

MFJ 1024 \$119.95 + \$5.00 UPS
A.C. Adapter \$9.95

- Outdoor active antenna
- Performs as well as units costing \$180.00
- WRTVH rates it high

BUTTERNUT SWL 2-30
\$49.50 + \$4.00 UPS

- Tune the weak ones in
- Stub tuned Dipole Maximum S/N Ratio
- 73 Feet long - 50 feet feed line

MAGNAVOX \$100.00 OFF



INTRODUCTORY PRICE
\$299.95 + \$7.00 UPS
LIST PRICE \$399.95

- All new PLL Digital Tuning
- Direct Key Frequency Input
- 16 Program memories
- 146 KHz - 29.999 MHz All Mode
- FM 87.5 - 108 MHz - Auto Search
- 12/24 Hour Clock - Alarm
- Wide/Narrow Bandwidth
- World Power 110-240V 50/60 Hz
- 12VDC External or Internal Battery

SANGEAN ATS-801



ONLY \$99.95 + \$4.00 UPS
LIST \$199.95

- SW 5.8-15.5 MHz FM88-108MHz
- LW 155-281 MW530-1620 kHz
- 25 Program Memories
- Digital Frequency & Clock Readout
- Manual or Autotone
- Same Weight and Size as SONY ICF 2002
- Free Stereo Hdset + 100 pg. SWL Book
- Optional A.C. Adapter \$14.95

SANGEAN ATS-803



INTRODUCTORY PRICE
ONLY \$179.95 + \$6.00 UPS
LIST \$349.95

Feature Between SONY 2002/2010

- Full coverage 150-29.999 KHz FM 88-108 MHz
- All Mode: AM-FM-CW-SSB
- 5 Tuning Functions: Keyboard-Autoscan-Manual Scan Preset-Manual Tuning Knob
- Radio-Clock Alarm Auto Turn On
- 9 Program memories. BFO
- RF Gain control to prevent overload from local stations
- AC Line Adapter + 100 pg SWL Book Included Batteries (Not Included)
- Same Weight and Size as SONY ICF 2010
- Stereo on FM W/Headset or Lineout

SANGEAN SG-789



ONLY \$59.95 + \$4.00 UPS
LIST \$99.95

- You'll take a second look at this fine 10 Band Radio - It's a copy of SONY ICF 4910 - Same Size and Weight
- SW Band 2.3 to 5 MHz (not covered by ICF4910)
- SW Bands 120, 90, 75, 60, 49, 41, 31, 25, 19, 16, 13 Meter
- MW 530-1600 FM 88-108 (Stereo Headset Out)
- Tuning Indicator
- The perfect gift for your loved one
- Let them enjoy the hobby of SWL
- Free Stereo Hdset + 100 pg. SWL Book
- Optional A.C. Adapter \$14.95

Dxer's Dream TOSHIBA RP-F11



(KENWOOD R-11)

Full page in 1985 WRTV
inside front cover for details

- Covers all International & Tropical Bands
- S Meter, Safety Off Lock

SAVE \$50.00 SALE \$79.95
+ 4.00 UPS

"One of the finest receivers available under \$130.00"

List \$129.95
Optional AC wall adapter TAC 64 \$11.95

*G.E. WORLD MONITOR

Sale
\$169⁹⁵

List \$229.95
(\$4.00 UPS)



- Digital readout, wide and narrow selectivity BFO for SSB & CW.
- 3.5 - 31 MHz SW/MW/FM
- 120V/220V or battery

DATA BASE INTERNATIONAL

- Here at last - Worth the wait
- Up to date picture of S.W. Broadcasting
- Frequency by Frequency - Hour by hour
- Innovative computer display. Makes easy reading of complex information
- Station Name, Location, Frequency, Time, Language, Target Area, Power
- In depth equipment review.



Vol. I International Broadcast \$9.95 + \$1.85 S/H
Vol. II Tropical Bands \$4.95 + \$1.85 S/H
Special Combo Vol. I & II \$12.95 + \$1.95 S/H

EEB
Electronic
Equipment Bank
516 Mill Street, N.E.
Vienna, VA 22180
(703) 938-3350

- Prices and Specs Subject to change
- Prices do not include Shipping Charges
- Payments: BankCard - Money Orders - Personal Checks - will delay shipping 3 weeks - No CODs.
- Returned purchases subject to 20% Restocking Fee.
- We ship UPS Daily - Cost for U.S. Mail is 3 times more than UPS

ORDER DESK HOURS:
MONDAY - FRIDAY
10 A.M. to 5 P.M. Eastern
SATURDAY 10 A.M. to 4 P.M. Eastern
Order Desk Phone Number:
800-368-3270

STORE HOURS:
Same as Order Desk Hours
Closed Mondays
Thursday 10 A.M. to 9 P.M. Eastern

EEB just 15 minutes from
Downtown Washington, D.C.
Plan a visit, your next trip.

Free Flyer in U.S., All others 3 IRC

ICOM R71A (HP)



High Performance World Class Receiver 100KHz-30MHz

NEW!

EEB is ICOM's #1 R71A Dealer. R71A for the serious DX listener. We're the leader in R71A modifications.

- 100KHz-30MHz
- Keyboard entry
- 32 Programmable Memories
- SSB/AM/RTTY/CW (FM Optional)
- Wide dynamic range
- Digital PLL Synthesized
- Memory scan
- Pass Band and Notch Tuning

ICOM OPTIONS

- CK-70: DC Connector Kit for External 13.8 VDC Operation (DC cord incl) \$9.95
- CR-64: High Stability Oscillator \$56.00
- EX-257: FM Unit, FM mode used only 29.5 to 30 MHz by amateurs. Some police. \$38.00
- EX309: Computer Interface Connector \$37.00
- EX310: Voice Synthesizer \$39.95
- FL32A: CW Narrow Filter (500 Hz) \$59.50
- FL44A: 8 Pole Crystal Filter (2.4 KHz) \$159.00
- FL63A: CW Narrower Filter (250Hz) \$48.50
- RC-11: Infrared Remote Control \$59.95

FREE: ICOM options will be installed at no additional charge with purchase of NEW ICR71A.

MEC-Commodore computer control Interface System. 705 Memories Auto Log. See our MEC Ads or call for more details.

INTRODUCTORY PRICE \$199.95
EX309 Required (Not Included).

R71 (HP) High Performance. EEB has the reputation of excellence when it comes to R71A modifications. Many of our modifications are proprietary and not offered by any other source.

EEB now offers a package deal including our most popular option, it's known as the R71 (HP) High Performance, and includes the following:

1. 24 Hour bench test. Realignment for optimum performance and 6 month warranty. COST \$40.00
 2. Mechanical 2.4 KHz Filter replaces stock ceramic SSB Filter: improves SSB, ECSS, and Narrow sensitivity. COST \$95.00
 3. Front End Upgrade - Improves Dynamic range (Plus) preamp enable below 1600 KHz COST \$35.00
 4. 4 KHz Filter replaces stock 6 KHz wide filter- improves AM Selectivity. COST \$50.00
 5. Audio output modification - increases audio output power, lowers distortion and widens audio bandwidth for pleasurable listening. COST \$35.00
 6. AGC time constant change decreases slow time and increases fast time constant COST \$35.00
 7. Spike protection added, no need to spend \$30.00 for a wall plug-in spike protector. It's installed right inside where it is most effective. COST \$25.00
 8. Final alignment and over-all check out COST N/C
 9. Installation of ICOM options purchased with your NEW R71A. COST N/C
- TOTAL COST OF THESE OPTIONS IS \$315.00**
Purchase the R71 HP and **SAVE \$115.00**
R71 HP (MF) Mechanical Filter \$849.00
R71 HP (XF) 8 Pole Crystal Filter \$899.00
R71A as it comes from ICOM \$649.00
FREE: One year Option - Purchase R71A from EEB at \$649.00 and you have 1 year to upgrade to the High Performance configuration HP (MF) \$249.00 HP(XF) \$299.00

ICOM R-7000



Commercial Receiver VHF-UHF 25-2000 MHz SAVE \$100.00

NEW!

Commercial quality scanning receiver. Same high quality as the world class R71A Receiver.

- 25-2000 MHz coverage
- Precise frequency entry via keyboard or tuning knob
- 99 Programmable memories
- Scan-Memory-Mode-Select Memory-Frequency
- 5 tuning speeds: 1, 1.0, 5, 10, 12.5, 25 KHz
- Narrow/Wide filter selection
- Memory Back-up
- Noise Blanker
- "S" Meter or center meter for FM
- AM, FM Wide, FM Narrow, SSB, CW

Watch for ICOM full page Ads for more details. EEB engineers are developing options for the enhancement of the R7000 performance-computer control video output, filter options and more. Call or Write for details.

R7000 LIST \$899.00

INTRODUCTORY SALE PRICE **\$799.00**



ELECTRONIC EQUIPMENT BANK

516 Mill Street, N.E.
Vienna, VA 22180

Order Toll Free: 800-368-3270

Technical and VA Orders (703) 938-3350

YAESU FRG-8800

SAVE \$100

150 KHz-30MHz
NEW LOW PRICE
\$499.95

LIST \$599.95



The FRG-7700 was a great receiver. Now the new generation FRG8800 takes you a step forward.

- CAT computer compatible
- 12 memories - scan- RIT
- Keyboard frequency entry
- Dual 24 hour clock timer recorder control
- Optional FRV8800 VHF converter 118-174 MHz \$99
- All mode AM - SSB - CW - FM
- Green LCD display
- 150 kHz to 30 MHz

EEB Exclusive Options

1. 24 hour bench test and complete realignment for optimum performance including double-extended warranty \$40
2. 4 kHz ceramic filter replaces 6 kHz AM Wide ceramic filter Installed \$50
3. 2.4 kHz mechanical filter replaces SSB ceramic filter Installed \$95

YAESU FRG9600

SAVE \$120



60-905 MHz
NEW LOW PRICE
\$479.95

LIST \$599.95

A premium VHF/UHF
scanning communications receiver.

- The 9600 is no typical scanner. And it's easy to see why.
- You won't miss any local action with continuous coverage from 60 to 905 MHz.
- Cable T.V. "Analyser." Check out everything on your cable.
- Satellite T.V. Analyser.
- You have more operating modes to listen in on: upper or lower sideband, CW, AM wide or narrow, and FM wide or narrow.
- You can even watch television programs by plugging in a video monitor into the optional video output. \$25.00
- Scan in steps of 5, 10, 12½, 25 and 100 KHz. Store any frequency and related operating mode into any of the 99 memories. Scan the memories. Or in between them. Or simply "dial up" any frequency with the frequency entry pad.
- Plus there's much more, including a 24-hour clock, multiplexed output, LCD readout, signal strength graph, and an AC power adapter.



ELECTRONIC EQUIPMENT BANK

516 Mill Street, N.E.
Vienna, VA 22180

Order Toll Free: 800-368-3270

Technical and VA Orders (703) 938-3350



Scanning The Iowa Highway Patrol

The Hawkeye State's Highway Patrol Offers Interesting Scanning

BY ANDREW WHITING

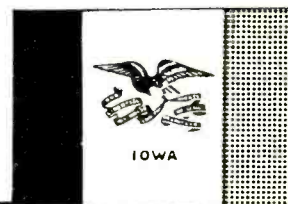

Readers Bill Smith (W5SUM), of Waterloo, Iowa, was kind enough to share with POP'COMM readers information he has on the communications systems of the Iowa Department of Public Safety (Iowa Highway Patrol).

Bill notes that the IHP's communications are always very professional sounding and the agency's system is "second to none." The main IHP frequencies for the county groupings are indicated for base and mobile stations. While county sheriffs and local police departments have their own systems and frequencies, they can communicate with the Highway Patrol and other law enforcement agencies over LEA frequencies given here.

The typical IHP base station runs 250 watts into an antenna mounted atop a 300-ft. tower.

A 10-Code is also given here and is used by most of the law enforcement agencies in Iowa.

Readers having similar information on state law enforcement agencies, or agencies in larger counties and metropolitan agencies are requested to send them in to POP'COMM.

Iowa Highway Patrol

Counties of Buena Vista, Calhoun, Cherokee, Clay, Dickinson,

Emmet, Ida, Lyon, O'Brien, Osceola, Palo Alto, Plymouth, Pocahontas, Sac, Sioux, Woodbury:

Communications Center in Storm Lake
Repeaters in Matlock, Merrill, Terri
IHP Base/Mobile frequencies: 155.64/154.65 MHz
LEA systems (base/mobile): 155.79/154.77 MHz

Counties of Cerro Gordo, Franklin, Hamilton, Hancock, Hardin, Humboldt, Kossuth, Webster, Winnebago, Worth, Wright:

Repeaters in Belmond, Blairsburg
IHP Base/Mobile frequencies: 155.655/154.755 MHz
LEA systems (base/mobile): 155.685/154.89 MHz

Counties of Allamakee, Black Hawk, Bremer, Buchanan, Butler, Chickasaw, Clayton, Delaware, Dubuque, Fayette, Floyd, Grundy, Howard, Mitchell, Winneshiek:

Communications Center in Cedar Falls
Repeaters in Gunder, Harpers Ferry, Holy Cross, Lourdes
IHP Base/Mobile frequencies: 155.565/154.665 MHz
LEA systems: 155.70/154.80 MHz

Counties of Audubon, Carroll, Crawford, Greene, Guthrie, Harrison, Monona, Shelby:

Repeaters in Denison, Moorhead, Springbrook
IHP Base/Mobile frequencies: 155.565/154.665 MHz
LEA systems: 155.70/154.80 MHz

Iowa "10-Codes"

| | | | |
|--|--|--|---------------------------------------|
| 10-1 Unable to copy - change location | 10-27 Drivers License information | 10-46 Assist motorist | 10-75 In contact with |
| 10-2 Signals Good | D. L. 1 - To check for valid license | 10-47 Emergency road repairs needed | 10-76 In Route |
| 10-3 Stop transmitting | D. L. 2 - To check for previous | 10-48 Traffic standard needs repairs | 10-77 ETA (Estimated Time of Arrival) |
| 10-4 Acknowledgement | O.M.V.U.I. convictions | 10-49 Traffic light out | 10-78 Needed assistance |
| 10-5 Relay | D. L. 3 - To check for age or | 10-50 Accident - F, PI, PD | 10-79 Notify coroner |
| 10-6 Busy - Stand by unless urgent | description or serial | 10-51 Wrecker needed | 10-80 |
| 10-7 Out of service (Give location | number, etc. | 10-52 Ambulance needed | 10-81 |
| and/or telephone number) | D. L. 4 - To check complete | 10-53 Road blocked | 10-82 Reserve lodging |
| 10-8 In service | driving record | 10-54 Livestock on highway | 10-83 |
| 10-9 Repeat | 10-28 Vehicle registration information | 10-55 Intoxicated driver | 10-84 If meeting _____ advise ETA |
| 10-10 Fight in progress | 10-29 Check records for wanted | 10-56 Intoxicated pedestrian | 10-85 Will be late |
| 10-11 Dog Case | 10-30 Illegal use of radio | 10-57 Hit and run - F, PI, PD | 10-86 |
| 10-12 Stand by (stop) | 10-31 Crime in progress | 10-58 Direct traffic | 10-87 Pick up checks for distribution |
| 10-13 Weather and road report | 10-32 Man with gun | 10-59 Convoy or escort | 10-88 Advise present telephone |
| 10-14 Report of prowler | 10-33 EMERGENCY | 10-60 Squad in vicinity | of _____ |
| 10-15 Civil disturbance | 10-34 Riot | 10-61 Personnel in area | 10-89 |
| 10-16 Domestic trouble | 10-35 Major crime alert | 10-62 Reply to message | 10-90 Bank alarm |
| 10-17 Meet complainant | 10-36 Correct time | 10-63 Prepare to make written copy | 10-91 Unnecessary use of radio |
| 10-18 Complete assignment | 10-37 Investigate suspicious vehicle | 10-64 Message for local delivery | 10-92 |
| 10-19 Return to _____ | 10-38 Stopping suspicious vehicle (Give | 10-65 Net message assignment | 10-93 Blockade |
| 10-20 Location | station complete description) | 10-66 Message cancellation | 10-94 Drag racing |
| 10-21 Call _____ by telephone | 10-39 Urgent - Use light and siren | 10-67 Clear to read net message | 10-95 |
| 10-22 Disregard | 10-40 Silent run - No light or siren | 10-68 Dispatch information | 10-96 Mental subject |
| 10-23 Arrived at scene | 10-41 Beginning tour of duty | 10-69 Message received | 10-97 |
| 10-24 Assignment completed | 10-42 Ending tour of duty | 10-70 Fire alarm | 10-98 Prison or jail break |
| 10-25 Report in person to (meet) _____ | 10-43 Information | 10-71 Advise nature of fire (size, type, | 10-99 Records indicate wanted or |
| 10-26 Detaining subject, expedite | 10-44 Request permission to leave patrol | and contents of building) | stolen |
| | _____ for _____ | 10-72 Report progress on fire | |
| | 10-45 Animal carcass in _____ lane | 10-73 Smoke report | |
| | at _____ | 10-74 Negative | |

Counties of Adair, Adams, Cass, Fremont, Mills, Montgomery, Page, Pottawattamie, Taylor:

Communications Center in Atlantic
Repeaters in Glenwood, Newmarket
IHP Base/Mobile frequencies: 155.655/154.755 MHz
LEA systems: 155.685/154.89 MHz

Counties of Boone, Clarke, Dallas, Decatur, Jasper, Lucas, Madison, Marshall, Polk, Ringgold, Story, Union, Warren, Wayne:

Communications Center in Des Moines
Repeaters in Dallas Co., Laurel, St. Mary's, Van Wert
IHP Base/Mobile frequencies: 155.64/154.65 MHz
LEA systems: 155.79/154.77 MHz

Counties of Benton, Iowa, Johnson, Linn, Poweshiek, Tama:

Communications Center in Cedar Rapids
Repeater in Brooklyn
IHP Base/Mobile frequencies: 155.655/154.755 MHz
LEA systems: 155.685/154.89 MHz

Counties of Appanoose, Davis, Henry, Jefferson, Keokuk, Lee, Louisa, Mahaska, Marion, Monroe, Van Buren, Wapello, Washington:

Communications Center in Fairfield
Repeaters in Albia, Burlington
IHP Base/Mobile frequencies: 155.565/154.685 MHz
LEA systems: 155.70/154.80 MHz

Counties of Cedar, Clinton, Jackson, Jones, Muscatine, Scott:

Repeaters in Maquoketa, Muscatine
IHP Base/Mobile frequencies: 155.64/154.65 MHz
LEA systems: 155.79/154.77 MHz

Statewide simplex frequencies:

Mutual aid: 155.475 MHz
Car to car: 155.43 MHz
Air/Radar: 155.505 MHz
CIS: 155.445

Tone coded squelch access:

Tone A: 127.3 Hz Tone C: 167.9 Hz
Tone B: 146.2 Hz Tone D: 192.8 Hz

PC

Now, It's Your Turn...



With Christmas obligations out of the way and the full force of winter crystallizing the landscape, perhaps it is time to reward yourself for a change—a time to explore the countless adventures Grove Enterprises can place at your fingertips. As publishers of *Monitoring Times* and manufacturers of unique performance-boosting equipment for the listener, Grove also stocks the latest books, microfiche directories, receivers like the amazing ICOM R-7000, scanners like the new Bearcat BC 800XLT, and sophisticated antennas for all quadrants of the radio spectrum. So, no matter how isolated your location nor how formidable the storm, Grove brings you instant access to the world. In the comfort of your own home.

Grove Enterprises

140 Dog Branch Road, Brasstown, N.C. 28902

(Write for a free catalog and sample issue of *Monitoring Times*)

CIRCLE 116 ON READER SERVICE CARD

Copy Worldwide Short-wave Radio Signals on Your Computer

Remember the fun of tuning in all those foreign broadcast stations on the short-wave radio? Remember those mysterious sounding coded tone signals that baffled you? Well, most of those beeps & squeals are really digital data transmissions using radioteletype or Morse code. The signals are coming in from weather stations, news services, ships & ham radio operators all over the world. Our short-wave listener cartridge, the "SWL", will bring that data from your radio right to the video screen. You'll see the actual text as it's being sent from those far away transmitters.

The "SWL" contains the program in ROM as well as radio interface circuit to copy

MICROLOG

INNOVATORS IN DIGITAL COMMUNICATION

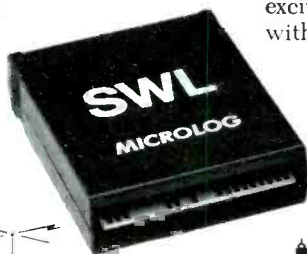

Morse code and all speeds/shifts of radioteletype. It comes with a cable to connect to your radio's speaker/earphone jack, demo cassette, and an excellent manual that contains a wealth of information on how to get the most out of short-wave digital DXing, even if you're brand new at it.

For about the price of another "Pac-Zapper" game, you can tie your Commodore 64, 128 or VIC-20 into the exciting world of digital communications with the Microlog SWL. \$64. Postpaid, U.S.
MICROLOG CORPORATION,
18713 Mooney Drive,
Gaithersburg, Maryland 20879.
Telephone: 301 258-8400.

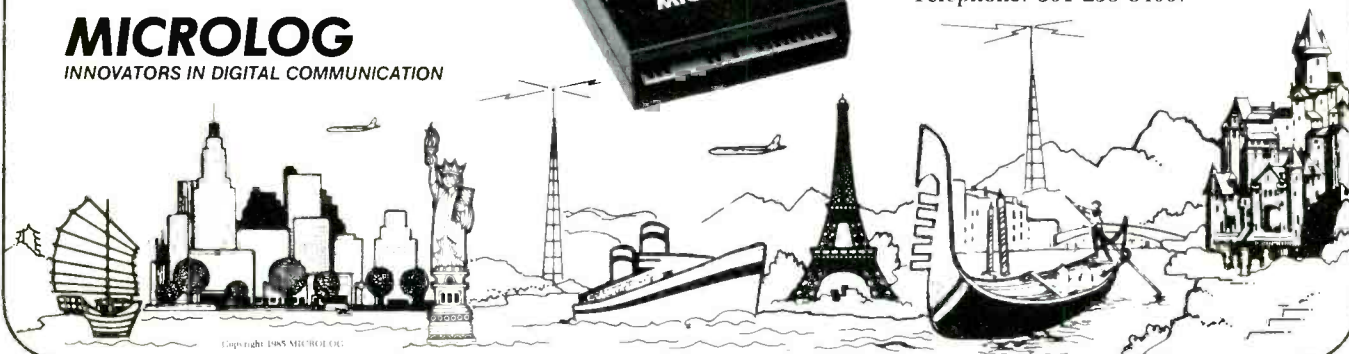

Copyright 1985 MICROLOG

RTTY 'Round The Clock

For A Change Of Pace, Tune In RTTY At Any Hour! Modern Technology Makes It Easy!

BY E.R. HOWARD, KNJ2MX

Gerry Dexter's POP'COMM feature listing 24-hour English language broadcast schedules inspired me to sort through my loggings of radioteletype (RTTY) stations heard over the past few days and select some representative listings heard at various hours throughout the day.

As with international broadcasting stations, RTTY stations can be logged at virtually any hour of the day or night. That makes it especially convenient when you want a change of pace from the shortwave broadcasting bands, or even from the evening's TV fare (and hasn't this season been really the worst in years?).

Easier Than You Thought

There was a time when monitoring RTTY was somewhat esoteric and required a modest amount of technical savvy. You had to obtain a surplus Teletypewriter and not only perform numerous conversion procedures, you also had to homebrew your way through a complex process in order to interface the Teletypewriter with your communications receiver. Forget about all of that today. The entire process of monitoring RTTY (and its related text transmission systems, ARQ and FEC) need not take more than a few minutes from start to finish. Anybody can do it. It requires no technical know-how and not even a soldering gun or a screwdriver!

The secret lies in receiver accessories that are "driven" by no more than the sound of the RTTY signal coming out of your receiver's loudspeaker. Plug one of the RTTY decoder units into your receiver's audio output, or just put a few clipleads on the set's loudspeaker connections, and you're ready to go. Tuning in the RTTY signals is your job (and enjoyment). That's all there is to it.

Some RTTY reading units have the text appearing on their front panel by means of anywhere from 6 to 12 LED's. The messages move from right to left in a continuous ribbon. More sophisticated units feed the text material into your personal computer or onto a video monitor screen (such as used for a personal computer), and can be used with a printer to give you a hard-copy printout.

Of course, the more sophisticated the unit, the more it costs (you thought otherwise?). One advantage of seeing the text on a video monitor is that you can view a full page of copy at a single glance, this as opposed to the constantly moving stream of letters via LED's. If the RTTY text is being

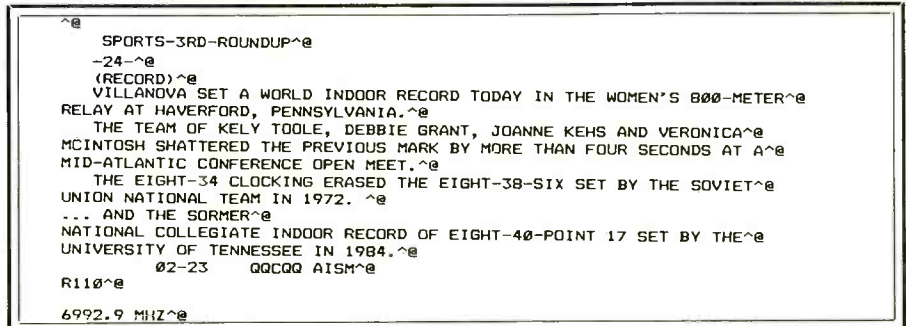

A hard-copy printout of an RTTY transmission monitored on 6992.9 MHz.

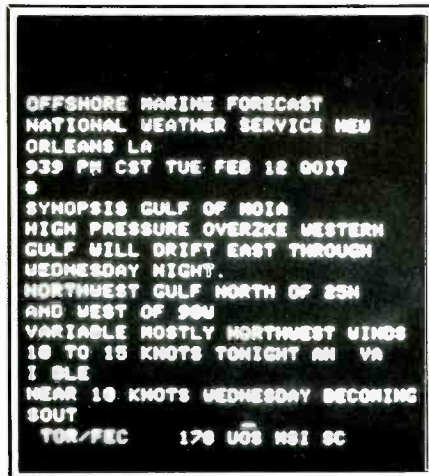

Here's how an FEC-mode weather broadcast looks on a video monitor.

sent at 75 WPM or faster, or if you get a couple of long words, text comprehension can get tricky. Once the stream of letters progresses through the series of LED's, it goes off into oblivion. That means you have to be willing to watch the LED's intently and be able to read and comprehend things at a relatively fast clip. Folks who move their lips or underline words with their index finger while reading will have to improve their reading skills. Nevertheless, the units with the self-contained LED's are quite inexpensive, they do work very well, and they're extremely popular.

Blip-Blip-Blip

RTTY signals, just in case you weren't sure, are those signals dotting the shortwave spectrum that sound like a coffee percolator gone bananas, and when you switch over to CW or SSB receiving mode, they sound like



At the bottom of this stack of gear is an Info-Tech M-600 multi-mode RTTY decoder, one of the more sophisticated units available to the monitoring enthusiast. It's capable of unraveling RTTY/ARQ/FEC and even CW. It also cracks "bit inversion" privacy codes!

a continuous high-speed stream of blip-blip-blips. Okay, it doesn't sound like much to the ear, but when you feed these sound-effects into an RTTY decoder, it comes out as news transmissions, telegrams, ship/shore communications, military, diplomatic, Interpol, government, weather, and other traffic.

Until you've witnessed it in action, it's difficult to really believe that intelligence can actually be extracted from those bizarre sounds. Not that each and every RTTY signal you'll hear is going to roll over gracefully and reveal to you its innermost secrets. Almost half of the RTTY signals you'll encounter aren't going to make any sense (to you). This is because deliberate measures have been taken (by those sending out the message) to insure a degree of privacy.

These measures may consist of the use of exotic transmission modes that most decoders can't handle, or the messages might be

| GMT | kHz | Mode | Callsign | Location | | | | |
|------|--------|---------|----------|--|------|---------|---------------|--|
| 0120 | 2212 | 425/50R | | SEDPEX oil rig, No. Atlantic | 1334 | 12500 | 170/50R UKEN | QUELLEN |
| | | | | Noted nightly after 2300 with RTTY/USB txc with personnel lists, supply requirements, etc. | | | | Soviet merchant vessel sending RYRY test slip |
| 0143 | 9217 | 850/50N | 5UA | Naimey, Niger | 1340 | 12510 | ARQ ELDH4 | IDA HELENE |
| | | | | Testing RYRY | | | | Liberian ship sending Telexes |
| 0149 | 5027 | 425/50R | FDY | Orleans, France | 1400 | 13850 | 425/50R 4XA83 | Tel Aviv, Israel |
| | | | | With test slip identical to 2320 GMT, but garbled | | | | Sending traffic consisting of lists of names |
| 0232 | 8356 | 170/50N | UYV | FIZIK LEBEDEV | 1450 | 14722 | 425/50R TNL | Brazzaville, Congo |
| | | | | Soviet freighter calling UFB & sending RYRY's | | | | Aeronautical station with RYRY slip |
| 0236 | 7407 | 425/50R | CML5 | Havana, Cuba | 1830 | 10429 | 425/50R Y7A44 | Berlin, GDR |
| | | | | Testing to ITT New York | | | | Diplomatic station with news in German |
| 0238 | 7442.5 | 425/75R | | Monrovia, Liberia | 1840 | 10816 | 425/50N | ? |
| | | | | News in French, parallel with 7478 kHz | | | | ANSA news in French |
| 0247 | 8354 | ARQ | GBTT | QUEEN ELIZABETH II | 1915 | 12112 | 425/75N | ? |
| | | | | Sending numerous Telexes to Portishead Radio | | | | Text (news?) in Russian language |
| 0300 | 7983 | 850/50N | | ? | 1940 | 13998 | 425/50N FTN99 | Paris, France |
| | | | | News and sports in English | | | | News in French |
| 0321 | 5016.2 | 425/50N | RPT1 | Pt. Delgado (Navy), Azores | 2010 | 15950 | 850/75R CXR | Montevideo, Uruguay (Navy) |
| | | | | Calling RPFN, sending "foxes" & RYRY | | | | Traffic to LOL, NBA, CPF2, HDN, and OBC. In Spanish, hand typed transmission |
| 0502 | 518 | FEC | NMF | USCG, Boston MA | 2011 | 12506 | ARQ 4PKM | PACIFIC UNIVERSAL |
| | | | | Maritime weather broadcast for No. Atlantic | | | | Ship located at 23.6N by 59.0W in contact with NMN sending AMVER report |
| 0530 | 4352 | FEC | WLO | Mobile AL | 2112 | 9200 | ARQ GMP | London, Great Britain |
| | | | | Maritime weather broadcast & traffic list | | | | INTERPOL station with repeating tape reading "IPUK" |
| 0805 | 12128 | 425/50N | IRJ31 | Rome, Italy | 2210 | 5460 | 425/75N WWV45 | Tangier, Morocco |
| | | | | ANSA news in English | | | | "GRA DE WASHINGTON DC CALLING" and RYRY then into Near East/South Asia Wireless File," stating "Distribution to mission staff only and not intended for distribution to public." |
| 1225 | 13537 | 425/50N | Y7A54 | Berlin, GDR | 2246 | 6270 | 170/50N UNLO | MOSKALENKO |
| | | | | News in German | | | | Soviet merchant vessel at Las Palmas with RYRY to Odessa |
| 1225 | 13072 | ARQ | GKE5 | Portishead, Great Britain | 2305 | 7428 | 850/50R | Argentina? |
| | | | | In contact with SS CUNARD COUNTESS (GUNP) with instructions regarding security measures to take in case of terrorist attack, including what to do "if radio room under siege." | | | | News in Spanish |
| 1225 | 10165 | 425/50R | RPT31 | Tashkent, Uzbek SSR | 2320 | 10834.6 | 425/50R FDY | Orleans, France |
| | | | | TASS news in French | | | | "VOYEZ LE BRICK GEANT QUE JEXAMINE PRES DU GRAND WARF" with RYRY and test counts |
| 1230 | 13524 | 425/50R | Y1071 | Baghdad, Iraq | 2326 | 10880 | 425/75R 5LA10 | Monrovia, Liberia |
| | | | | INA news in English | | | | Announcing "VOA WASH DC" with RYRY test slip |
| 1240 | 13842 | 850/75R | KRH51 | London, Great Britain | | | | |
| | | | | U.S. Dept. of State station with "foxes" | | | | |

sent coded into groups of 5 digits or letters, or they might have been computer encrypted into what will appear to be in the language of the jabberwocky. One type of signal that is absolutely impossible to copy is not only encrypted, but also alternates between two transmission frequencies (about 800 Hz apart) every 8 to 10 seconds. Such signals have been noted at about 10102, 14727, and 16980 kHz. (A warbling RTTY "jammer" operates on 15085 kHz. It's 425 Hz "wide.")

One shouldn't get too bent out of shape by these and other encryption methods. There are so many RTTY signals to explore that your log will overflow with the 50% of the signals that you'll copy with ease. Not only that, but you can even obtain RTTY reading units that are fully capable of penetrating an RTTY privacy method known as "bit inversion."

ARQ/FEC

Modern communications technology has produced RTTY-like text transmission systems called ARQ and FEC. The ARQ system sounds like a series of pulses (or perhaps CW *dih's*). FEC is a steady stream of data that sounds something like regular RTTY, but not quite the same.

While ARQ is used heavily in the maritime communication bands for sending/receiving Telexes, it has been noted on Interpol channels, in the Ham radio bands, and elsewhere. FEC is used primarily for one-way transmissions, such as weather broadcasts or long lists of ship callsigns ("traffic lists").

While many decoders can copy CW as well as RTTY, not all are able to tackle either ARQ or FEC transmissions. What with ARQ/FEC experiencing increasing popularity and the interesting messages the transmissions often contain, the ability to "read" such



An old-style RTTY station using the bulky equipment that has mostly been replaced by modern technology. This stuff clattered away and sounded like a Thompson submachine gun!

communications significantly increases the scope of your monitoring ability over and above RTTY alone.

If you want to get a quickie peek at what ARQ sounds like, put your receiver into either the USB or LSB receiving mode and tune (nights) between to 4219 and 4357 kHz or (days) to 16859 to 17232 kHz. Mixed in with the CW signals, you'll hear ARQ's distinctive signal pulses. These are,

of course, only two of the many areas of the spectrum where you can find ARQ signals.

Not Just Nosy

Monitoring RTTY isn't simply a matter of reading other people's electronic mail. It's a great way to get a handle on the information that's going to appear on the TV news and in the newspapers before the information is

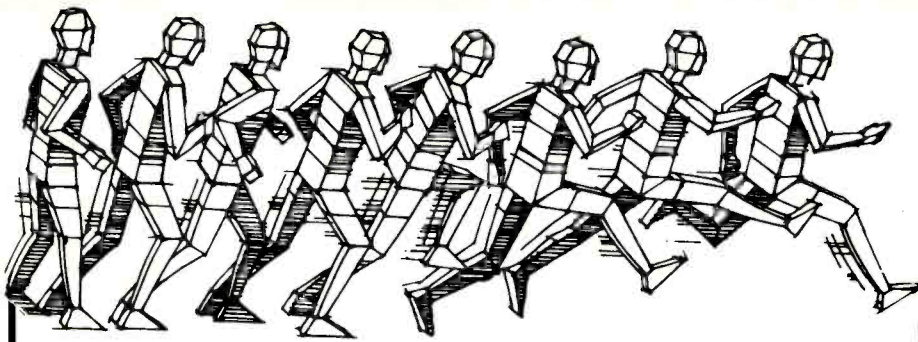

SUBSCRIBE TO



THE GREAT NEW MAGAZINE FOR ELECTRONICS & COMPUTER ENTHUSIASTS

Now you can reach out every month and learn about the latest innovations in consumer electronics and personal computers—what's new, how products and circuits work, and what leading authorities think of them.

- *Stereo *Video *Home & Car Electronics
- *Test Instruments *Circuitry & Devices *Servicing
- *Personal Computers *Communications *Construction Projects

In every issue, authors lucidly explain how exciting, new electronics ideas are applied . . . issue forthright buying counsel . . . present complete plans to build electronic devices to enhance products, even unique ones that are not yet being sold in the marketplace.

Feature articles, tutorials, and construction projects are the hallmarks of MODERN ELECTRONICS, the monthly magazine for electronics and computer enthusiasts. Covering the entire spectrum of these fields, you'll gather insights in every important area to help you make buying decisions for work and play purposes . . . improve performance of your present equipment . . . increase your electronics competence . . . and add to your practical and intellectual knowledge of electronics and computers.

To be sure you get this valuable information delivered to you regularly, and share the experiences of our writers and editors—Forrest Mims, Len Feldman, Stan Prentiss, Charles Rubenstein, Don Lancaster, and many others—you can subscribe to MODERN ELECTRONICS today.

Published by the same people who produce CQ The Amateur Radio Journal and Popular Communications magazines, it's guaranteed to fully satisfy you or we'll refund your unused subscription portion, no questions asked.

Just fill out the coupon and mail with your check, money order, or credit card information (Visa or MasterCard) to enter your subscription. Do it today to ensure earliest delivery!

MODERN ELECTRONICS

76 North Broadway, Hicksville, NY 11801

Please send me Modern Electronics for 2 Years 1 Year

Name _____

Street _____ 2 Years (24 issues) \$31.00

City _____ 1 Year (12 issues) \$16.97

State _____ Zip _____

Charge My Order To: Payment Enclosed \$ _____

MasterCard

VISA

My account number is:



presented by the national media. By copying RTTY news transmissions, you may well be seeing information simultaneously with members of the major news gathering organizations in North America!

It seems that most of the world's news and governmental propaganda agencies operate large banks of RTTY printers hooked to communications receivers. This equipment is tuned to many of the same stations you can pick up in your own home! In addition to straight news, some transmissions include the latest stock market and precious metal prices, plus sports scores.

Hop On Board

RTTY monitoring looks to be the fastest growing aspect of shortwave monitoring; it numbers among its recent converts many listeners who had previously been interested strictly in SW and BCB broadcast monitoring. Most of these people never before gave "ute" monitoring a second thought, but somehow they caught the highly contagious RTTY "bug." It could happen to you, too!

If you have already been bitten, use the listing here to add to your enjoyment. If you haven't yet been bitten, why not peruse the accompanying listing and see what you're missing.

Next, check out the large and varied assortment of equipment in all price ranges that you can use to add "extra ears" to your existing monitoring capabilities. The following companies can give you information about their RTTY decoders. Please tell them POP'COMM sent you!

- Microlog Corp., 18713 Mooney Drive, Gaithersburg, MD 20879.
- HAL Communications Corp., Box 365, Urbana, IL 61801.
- Universal Shortwave Radio, 1280 Aida Drive, Reynoldsburg, OH 43068.
- Kantronics, 1202 East 23rd St., Lawrence, KS 66044.
- Advanced Electronic Applications, P.O. Box 2160, Lynnwood, WA 98036.
- Microcraft Corp., P.O. Box 5130, Thiensville, WI 53092.
- Digital Electronic Systems, Inc., 1633 Wisteria Court, Englewood, FL 33533.

Your favorite local or mail order communications dealer may carry RTTY decoding equipment; ask them about it!

This Very Night

Tonight, or the next time you flip on the receiver, allow yourself to tune outside the confines of your usual haunts in the shortwave broadcasting bands.

In short order you'll hear that distinctive RTTY sound—the wacked-out coffee percolator (actually it sounds a lot like the Snapper lawnmower I bought last summer—it sounded like it had emphysema after the second week I used it). Well, that'll be an RTTY signal and won't you wonder about what you're missing—maybe a fascinating Telex, or military traffic, or a station in a country you've never before monitored. Lots of other folks know what that transmission is. Sorry that you don't. (Yet!) **PC**

New
800 MHz models

Regency Scanners

*Bring you the Excitement of Police,
Fire, Emergency Radio, and more.*



MX5000



MX4000



MX3000

Our radios deliver the local news. From bank hold-ups to three alarm fires. It's on-the-scene action. While it's happening from where it's happening . . . in your neighborhood.

You can also listen to weather, business and marine radio calls. Plus radio telephone conversations that offer more real life intrigue than most soap operas. And with our new models, there's even more.

Unique Capabilities

Introducing two all new Regency scanners. First, there's the MX7000, a 20 channel, no-crystal unit that receives continuously from 25 to 550 MHz and 800 MHz to 1.2 GHz. That's right! Continuous coverage that includes VHF and UHF television audio, FM Broadcast, civil and military aircraft bands and 800 MHz communications. Next in line is the new MX4000. It's eight band coverage includes standard VHF and UHF ranges with the important addition of 800 MHz and aircraft bands. Both units feature keyboard entry, a

multifunction liquid crystal display and selectable search frequency increments.

Practical Performance

If you don't need the 800 MHz range coverage, Regency offers two exciting new units. The MX5000 is a 20 channel, no-crystal scanner that receives continuously from 25 to 550 MHz with all the same features as the MX7000. Then there's the 30 channel MX3000. It's digitally synthesized so no crystals are necessary, and the pressure sensitive keyboard makes programming simple. What's



more, it has a full function digital readout, priority, search and scan delay, dual scan speed, and a brightness switch for day or night operation.

At Home Or On The Road

With compact design, easy access front panel and mounting bracket these Regency scanners are ideal for mobile* use. But we also supply each radio with a plug-in transformer and a telescoping antenna so you can stay in touch at home. The MX4000 even has a rechargeable battery pack so it's fully portable.

See your Regency Scanner Authorized Dealer for a free demonstration on these and other new Regency Scanners. Or, write Regency Electronics, 7707 Records Street, Indianapolis, IN 46226.

Regency

ELECTRONICS, INC.®
7707 Records Street
Indianapolis, IN 46226-9989

*Mobile use subject to restriction
in certain localities.

CIRCLE 62 ON READER SERVICE CARD

Remembering Radio

Radio Communications And Broadcasting In Days of Yore

BY ALICE BRANNIGAN

Dave Marshall of The All Ohio Scanner Club sent *POP'COMM* a wonderful series of photos that he found recently in files that belonged to his late father. The only identification Dave could come up with was that the callsign W8YX appears on the roof of the station, but Dave knew nothing more of the station.

That set us digging around in some old files of our own and we came up with the information that, around 1930, W8YX was located in Swift Hall at the University of Cincinnati, Ohio. This station was licensed as a Technical and Training School station, a former category of stations that were somewhere between Amateur and Experimental licensees. These stations apparently operated in the Amateur bands. They were readily identified by the letter "Y" immediately following the Radio District numeral. (Experimental stations had an "X" as the letter following the numeral.)

Actually, in the old days, the delineation between Amateur, Experimental, Special, Training School, and even Broadcast stations wasn't all that sharp; there was often some degree of overlap. A good example of this can be seen in the illustration here of an unusual QSL from a single station holding the Ham call 8VE, the Special Land call 8ZD, and also the Experimental callsign 8XW. This 3-in-1 1926 QSL from Pittsburgh was from operators F.B. Westervelt and Parker E. Wiggin for a contact with an operator in Santa Monica, California.

From Minneapolis

Another terrific glimpse of history arrived here from Thomas Gavaras, Assistant to the Marketing Director of station WCCO (830 kHz, 50 kW) in Minneapolis, Minnesota. Tom was kind enough to send us a copy of a book entitled *Sixty Years Strong*, the illustrated story of this well-known, clear channel station. The book came out in 1984 and sold out almost immediately, thus making it a collectors item!

WCCO, as related in this fascinating book (written by Larry Haeg, Jr.), began its career in 1922 as WLAG, a 500 watt station on 730 kHz. Unfortunately, WLAG went bankrupt in 1924, and it was only through the hard work of several dedicated Twin Cities residents that within six weeks WLAG's facilities had been purchased and the station went back on the air, this time on 740 kHz. Three weeks later, a new set of call letters



Station W8YX sent out its signals from this building on the campus of the University of Cincinnati.

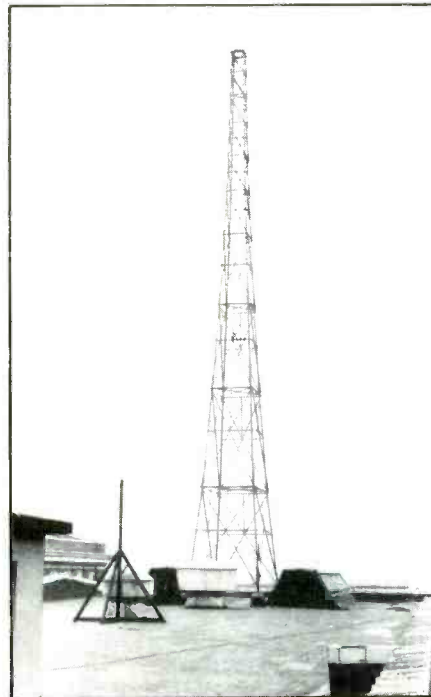

A closer view of one of the W8YX transmitting towers.



Looks like the W8YX radio shack was a great place to hang out while cutting classes.

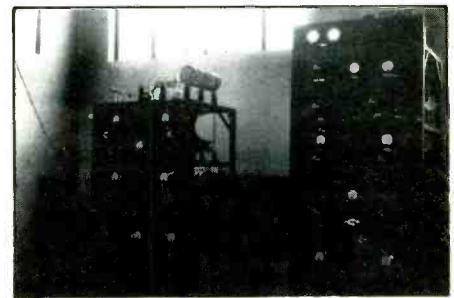

The W8YX rack-mounted transmitting gear.

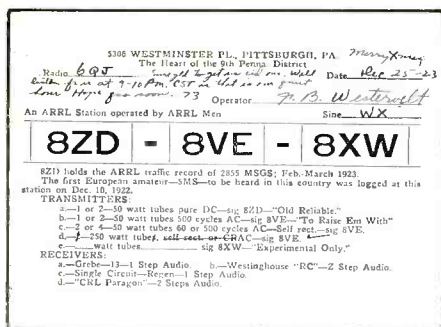

An all-purpose QSL from a station licensed in no less than three different radio services. It dates from 1923.

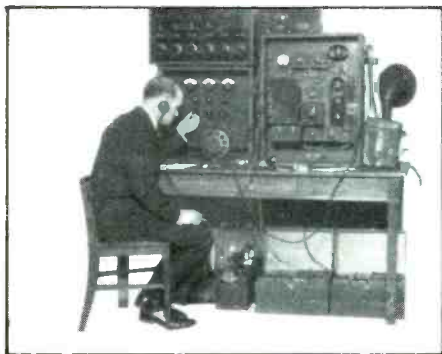

WLAG's C.E. Ray Sweet, tunes up the equipment. Hard to believe that from these humble roots sprang today's mighty WCCO! (Photo courtesy WCCO)

(WCCO) was assigned to the station. The rest is history.

It is too bad that this fascinating book is no longer available because it is filled with photos and facts regarding the career of this station, a station that has surely been heard by every North American devotee of broadcast band DX. We greatly appreciate having a copy to add to our reference library.

Lost And Found

In the November issue I ran a photo of a large and imposing broadcaster in Austria which I could identify only as "Bisamberg Sender." It was obviously a station from the early 1930's, but I wasn't able to locate its frequency or any details about the location of Bisamberg.

Several POPCOMM readers came quickly to the rescue with all sorts of information. Stan Horzempa (WAILOU), of ARRL HQ, and Jim Selfridge of Remsen (New York) wrote to say that Bisamberg is a suburb of Vienna. It's a location with a rather high hill. Reader Felix Stein, of Feeding Hills (Massachusetts) noted that the hill, in fact, is right next to the Danube River and is an important historical site because of its connection with the Turkish siege of Vienna in the year 1683. It turns out that Felix listened to Bisamberg Sender (592 kHz, 120 kW) when he was a youngster in the days before WWII. Felix, as well as Erwin Watzke (Windsor, Ontario) and Dick Evans (with the U.S. Navy in Keflavik, Iceland), pointed out that this hill is still the site of broadcasting activities. Presently, there are two transmitters



Thanks to POP'COMM readers, this mystery station in Austria was identified. The hill in Bisamberg is an historic site.

known as *Osterreichischer Rundfunk*, 585 kHz (600 kW) daytime, and 1476 kHz (600 kW) nights.

Gulp! I really feel like such a dummy for not knowing any of this without having to call for help. Nevertheless, POP'COMM readers set me straight. You guys are the greatest!

Felix Stein thanked me for bringing back his pleasant memories of the station in our photo. He also recalled that just across the Danube from the station are the breathtaking Vienna Woods, "a beautiful spot for hiking and wine drinking." Sounds like the kind of place someone ought to write a song about. Johann Strauss, please note!

Better Late Than Never

Thanks to Edward Kusalik (Coaldale, Alberta), I was made aware of the recent anniversary of station CJOC (1220 kHz, 10 kW) in Lethbridge, Alberta.

CJOC was started in 1926 by Joc Palmer, who installed a 50 watt transmitter (operating on 1000 kHz) in a shed behind his mother's house. The callsign was devised from Palmer's first name. CJOC operated for two years with the transmitter in the backyard shed and studios in the rear of the premises at 3rd Avenue and 7th Street South.

Eventually CJOC was sold and the station was moved by its new owners to the Marquis Hotel. The power was increased to 100 watts, the antenna being a long wire running across the roof of the hotel.

The year 1933 saw CJOC move into the penthouse of the hotel and it commenced

RECEIVE RTTY/ASCII/CW on your Personal Computer



RTTY/ASCII/CW SWL COMPUTER INTERFACE MFJ-1225 **\$ 69.95**

FREE MFJ RTTY/ASCII/CW Software TAPE AND CABLE FOR VIC-20 OR C-64. ORDER MFJ-1225/FMJ-1264 FOR VIC-20 OR MFJ-1225/FMJ-1265 FOR C-64.

Receives commercial, military, and amateur RTTY/ASCII/CW using your personal computer. The MFJ-1225 Computer Interface plugs between your receiver and VIC-20, Apple, TRS-80C, Atari, TI-99, Commodore 64 and most other personal computers. Requires appropriate software.

Copies all shifts (850, 425, 170 Hz shift and all others) and all speeds. Automatic noise limiter suppresses static crashes for better copy. 2 LED tuning indicator makes tuning fast, easy, positive. 4 1/2 x 1 1/4 x 4 1/4 in. 12-15 VDC or 110 VAC with optional adapter, MFJ-1312, \$9.95.

INDOOR TUNED ACTIVE ANTENNA

MFJ-1020 **\$ 79.95**



MFJ-1020 New Indoor Active Antenna sits on your desk ready to listen to the "Rivals, often exceeds, reception of outside long wire. Unique Tuned Active Antenna minimizes intermode, provides RF selectivity, reduces noise outside tuned band. Also use as preselector for external antenna. Covers 300 KHz to 30 MHz in 5 bands. Adjustable telescoping antenna. Controls: Tune, Band Selector, Gain, ON-Off/Bypass, LED, FET, bipolar circuitry. Phonojack for external ant. 6x2x6 in. 9-18 VDC or 9V battery. 110 VAC with adapter, MFJ-1312, \$9.95.

REMOTE ACTIVE ANTENNA

54 inch remote active antenna mounts outdoor away from electrical noise for maximum signal and minimum noise pickup. Often outperforms longwire hundreds of feet long. Mount anywhere atop houses, buildings, balconies, apartments, mobile homes, on board ship.

Use with any radio to receive strong clear signals from all over the world. 50 KHz to 30 MHz.

High dynamic range eliminates intermodulation. Inside control unit has 20 dB attenuator, gain control. Switch 2 receivers and auxiliary or active antenna. "On" LED. 6x2x5 in. 50 ft. coax. 12 VDC or 110 VAC with MFJ-1312, \$9.95.



MFJ-1024 **\$ 129.95**

Order from MFJ and try it. If not delighted, return within 30 days for refund (less shipping).

One year unconditional guarantee.

Order yours today. Call toll free 800-647-1800. Charge VISA, MC. Or mail check, money order. Add \$4.00 each for shipping and handling.

CALL TOLL FREE ... 800-647-1800

Call 601-323-5869 in Miss., outside continental USA, tech/order/repair info. TELEX 53-4590

MFJ ENTERPRISES, INCORPORATED

Box 494, Mississippi State, MS 39762

CIRCLE 147 ON READER SERVICE CARD

March 1986 / POPULAR COMMUNICATIONS / 23

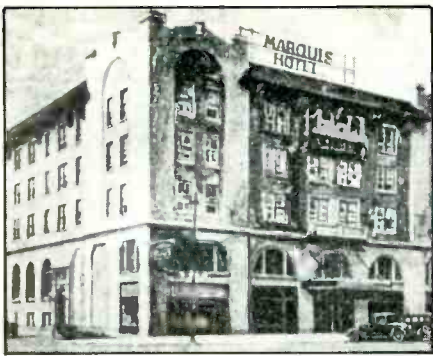

Here's how the Marquis Hotel looked when CJOC moved its facilities there. The antenna was a longwire on the roof.

broadcasting local hockey games via remote pickup. In 1936, CJOC became the first station in Canada to carry "Radio School of The Air" programs. Because of CJOC's extraordinary community service during a severe 1967 blizzard, the broadcaster was named "AM Station Of The Year" by the Canadian Association of Broadcasters in 1968.

Presently, CJOC has grown to a large staff of 50 full time and 9 part time employees.

POP'COMM salutes CJOC during its 60th year of continuing service to Southern Alberta! We raise a mug of Molson Golden in the direction of Lethbridge.

Hoosier Happenings

Herb Harnish of Fort Wayne, Indiana passed along two photos from the early-to-mid-1930's during the almost forgotten days when local broadcasters WOWO and WGL shared their studios at 213 West Main Street.

WGL claims its heritage back to 1924 when it was owned by Fred Zieg of the Allen-Wayne Co. In 1930 it was operating with 200 watts on 1370 kHz. By 1946 it was owned by the Farnsworth Television and Radio Corp., 201 West Jefferson St., and was running 250 watts on 1450 kHz. These days the station runs 1 kW on 1250 kHz with an all news program format.

WOWO looks back to 1925 as its starting point. As the station of the Main Auto Supply Co., in 1930 it was on 1160 kHz with 10 kW. The station was eventually purchased by Westinghouse Radio Stations and by WWII had moved to 1190. Today the station remains on 1190 kHz but runs 50 kW, and is under new ownership.

In our two photos, both WGL and WOWO had their studios on the 2nd floor of the Main Auto Supply Building.

In the photo of the studios, WGL (note callsign on the microphone above the head of Percy, the pianist) was in the midst of its daily one-hour "live audience" program called "Shoppers' Matinee."

The WOWO photo shows the station's transmitting apparatus, also located at 213 West Main Street. For reasons I haven't yet figured out, the Ham callsign 9DVP is writ-



Percy, the pianist, tickled the ivories during the daily live broadcast over station KGL in Fort Wayne. Note the callsign on the microphone above Percy's head. Also take a gander at the lavish air conditioning system atop the piano. This studio was shared with station WOWO.

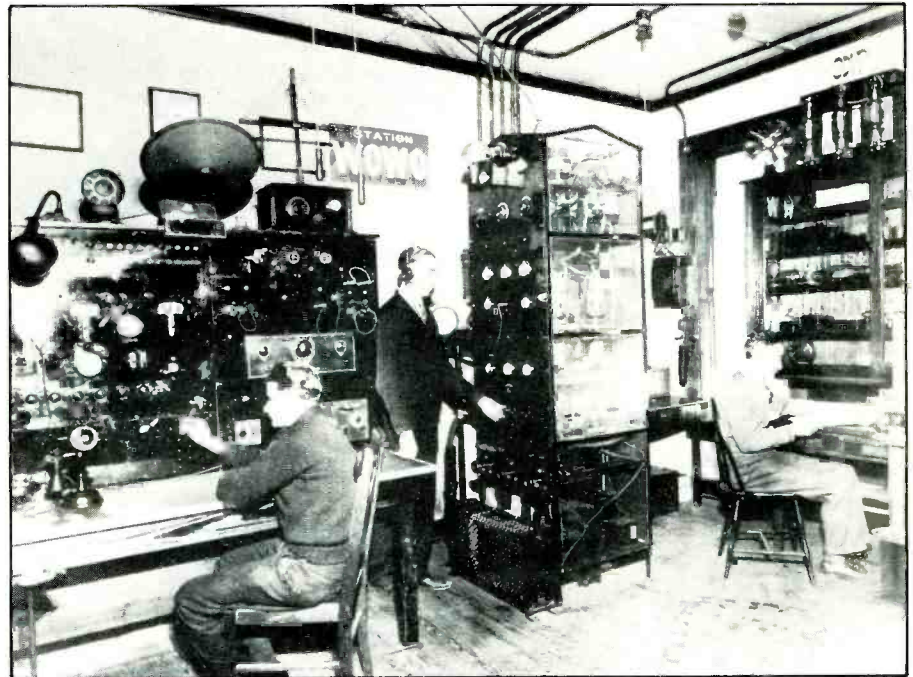

WOWO's transmitting plant was quite impressive. But why is the Ham callsign "9DVP" written on the wall at the upper right?

ten on the wall near the ceiling at the far right. Possibly it was the call of one of the WOWO staff members (records show that the callsign belonged to someone from St. Louis, Missouri).

Of Tin Cans

Here's a case where the QSL came by "Tin Can Mail." That's how it was if you wanted a QSL from station ZCO (7.5 watts

CW on 500 kHz) during the 1930's. ZCO was located on Niuafou Island (Tonga group), a tiny isolated isle surrounded by dangerous currents and reefs. Such was Niuafou's situation that the residents there found it hard to send and receive mail since few volunteers were interested in ferrying even a small canoe out to the mail boat lying offshore. For a while, in the 1920's, the mail was moved through the coastal tides and

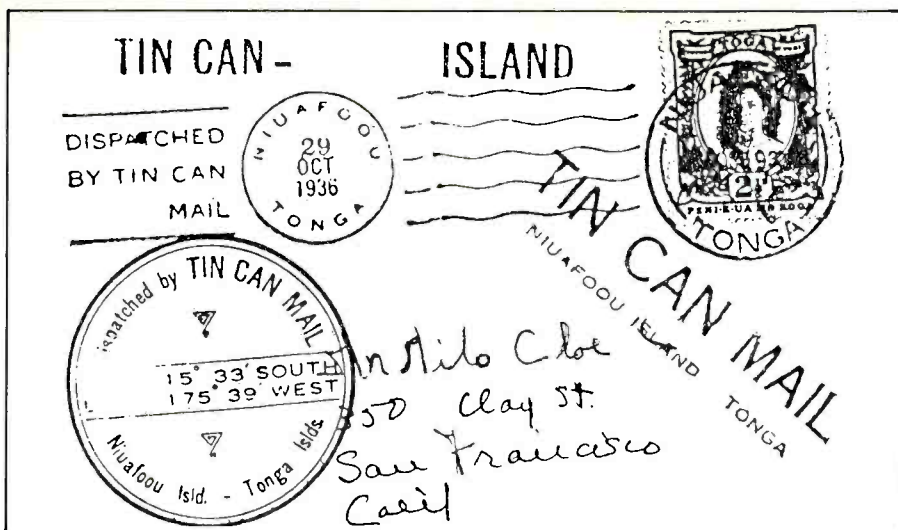

Tin Can Mail was probably the most unusual way QSL's were ever sent out. The envelope was as collectable as the QSL itself!

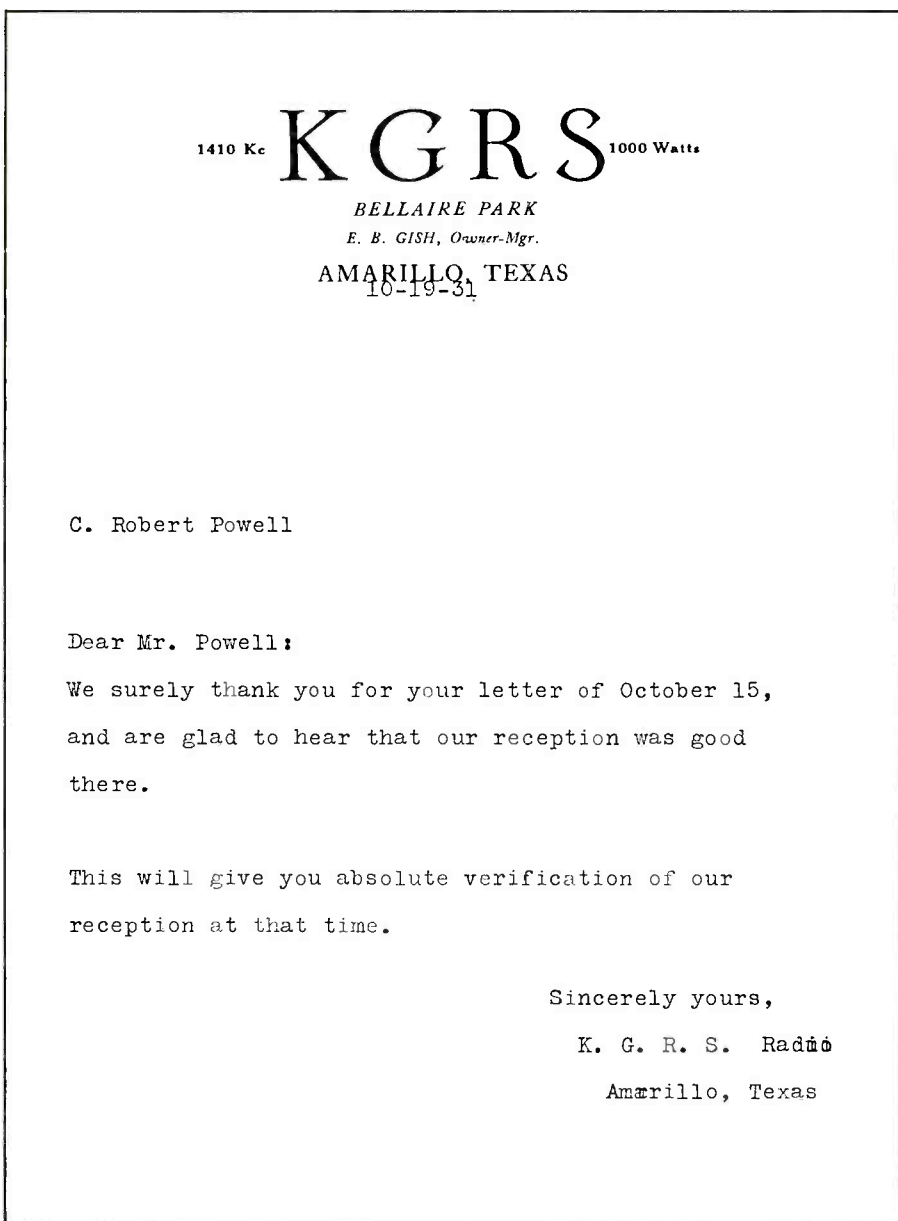

This 1931 QSL letter from station KGRS represents only one link in the evolution of modern-day station KGNC, Amarillo, Texas.

reefs because someone on the island was willing to swim out to the mail boat with the letters attached to a floating log.

It was when Walter G. Quensell arrived on Niuafuou in the 1930's that the mail service improved. Quensell went there to be the island's radio operator. In order to send and receive his own mail, he hired natives to ferry the mail by means of dugout canoes carrying his letters to and from the island in cookie tins. He called this Tin Can Mail, and even made up a hand stamp calling attention to his unique mailing system.

His mail cancellations eventually became highly prized by stamp collectors, and by the late 1930's he was sending out about 1,000 letters at a clip. In addition to letters intended for philatelists, these included his own official correspondence plus occasional requests for QSL's from his CW station, ZCO.

The Tin Can Mail service was stopped by WWII but started up again in 1946, but only briefly because the local volcano caused the population (about 1,300) to temporarily flee to other area islands. Quensell never returned; his Tin Can Mail had ended.

It wasn't only that station ZCO was hard to hear, it was that the envelope they sent the QSL in was more interesting than the QSL itself!

Deep In The Heart Of Texas

I've always found it interesting to see the evolutionary history of a modern radio station and how it has changed callsigns, frequencies, and owners over the years.

When I came across a 1931 verification letter from KGRS in Amarillo, Texas it started me tracing where it came from and where it went (since it appeared only in listings from 1926 to 1935). Some early stations, of course, have no past and no present. They went on the air and then out of business all within a few short years, hardly leaving a footprint to study.

But KGRS was quite different, I was to learn.

This station began its career quite early as broadcasting history goes—1922 to be precise. When E. B. Gish, the station's owner and manager, went into business as the Gish Radio Service (108 East 8th Street), he wanted to broadcast to radios as well as sell and repair the sets. This was a rather common practice—the more broadcasting stations in operation, the more reasons for the public to buy radio receivers! Radio stores of the 1920's, therefore, were among the earliest broadcasters!

Gish's station went on the air as WQAC, 100 watts on 1280 kHz. Gish, ever the businessman, claimed that the letters in the callsign stood for the words *Where Quality Alone Counts*.

By late 1926, with radio broadcasting's newness and initial novelty having worn off a bit, WQAC underwent a transition. The frequency was shifted to 1410 kHz, the power was increased to 1 kW, and Gish had the callsign changed to KGRS (thus incorporating the initials of his company).

In 1931, Gish relocated the station's

"INSIDER'S INFORMATION"

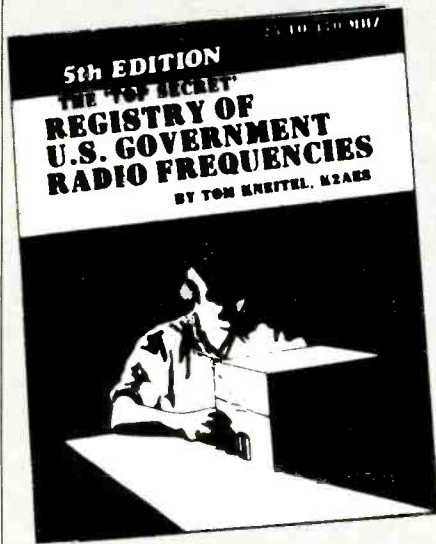

Since 1967, CRB Research has been the world's leading publisher and supplier of unique hobby and professional books and information including:

- Scanner Frequency Guides
- Shortwave Frequency Guides
- Military/Federal Communications
- Broadcast Station Registries
- Undercover Communications
- Survival Communications
- Covert Operations
- Electronic Espionage
- Surveillance
- Monitoring
- Cryptography & Codes
- Bugging
- Wiretapping
- Communications Antennas
- Electronics & Projects
- Authentic Combat Communications Cassettes
- Computer Technology
- & Other Related Topics!

New titles are constantly being added to our exciting catalog. If it's interesting and unusual, we've got it. You'll see! Ask for our latest FREE catalog!

CRB RESEARCH
P.O. Box 56 Commack, NY 11725

transmitter to Bellaire Park on the Gulf Highway in Amarillo. The station continued operation this way until early 1935, when Gish sold it to the Plains Radio Broadcasting Co. The station's new owners, initially, made one significant change. They dropped the KGRS callsign and changed it to KGNC.

When the government shifted the operating frequencies of many stations just before WWII, KGNC ended up on 1440 kHz. By the time WWII had ended, KGNC was running 5 kW days and 1 kW at night on 1440 kHz.

Broadcast band DX'ers and current residents of the Amarillo area should, by now, recognize KGNC as the 10 kW station now operating on 710 kHz. So our QSL letter from KGRS represents a transitional link in the history of modern-day station KGNC that helps to trace it back to the dawn of broadcasting.

Reference Material

Some of my mail from readers asks for sources of information on antique radio circuits, repair, restoration, equipment, collecting, and related topics. I'd like to recommend as a source of many reference books on these topics, Vestal Press, P.O. Box 97, 320 N. Jensen Road, Vestal-123, NY 13850. Vestal's large (56-page) illustrated catalog normally sells for \$2, however, I have made arrangements for the company to supply it at no cost to any of my readers who request a copy.

Vestal has a very good selection of books

!! PRICE BEATER !!

40TH ANNIVERSARY EDITION
OF THE AUTHORITY DIRECTORY OF
INTERNATIONAL RADIO AND TELEVISION

\$16.99 **W R T H**

Free shipping with this ad

Catalog-\$1.00

RADIO WEST
(619) 741-2891
3417 Purer Rd.
Escondido, CA 92025

CIRCLE 131 ON READER SERVICE CARD

UNSCRAMBLERS

For Police, Fire & Emergency Channels

Satisfaction Guaranteed

Write or Call

501-623-6027
DNE, Inc. Rt. 7, Box 257-C
Hot Springs, AR 71901

on antique radios and tubes. They also have many books on player pianos and other antique automatic musical instruments—their history and restoration. Be sure to tell them you read about it in *POP'COMM!*

See you next month!

PC

Historic Ham QSL's

For many years, maps of the Middle East revealed the existence of two odd triangular shaped areas of desert land. Usually they were labelled "Neutral Zone." Their combined size was only about 1,000 square miles and both were located on Saudi Arabia's northeast boundaries with Iraq and Kuwait.

These two zones weren't included in any nation's sovereignty because of conflicting boundary claims of the governments involved.



The Saudi Arabian/Iraqi Neutral Zone, although quite desolate and remote, still had some occasional Ham band activity from stations utilizing an 8Z4 prefix (the prefix belongs to Saudi Arabia). The Saudi Arabian/Kuwaiti Neutral Zone, on the shores of the Persian Gulf, was far less obscure since the Aramco oil camps at Ra's al Khafqi are beehives of activity. Ham operators in that area used the Saudi prefix 8Z5, also 9K3 (from Kuwait).

Although each of these Neutral Zones was a true "No Man's Land" in every sense of the term, they counted as actual countries when DX operators connected with operators there. Although the Saudi Arabian/Iraqi Neutral Zone is still shown on recently printed maps, the ARRL will not recognize (for DX credit) any contacts made with 8Z4 stations after 25 December 1981. The Saudi Arabian/Kuwaiti Neutral Zone was eventually incorporated into Kuwait, so contacts made with 8Z5 or 9K3 stations count for separate country credit (under ARRL DXCC rules) only if they date from before 15 December 1969.

The QSL shown here is from Aramco employee Vic Crawford, who held Saudi Arabian license HZ3TYQ during the 1960's. He made a one-man DXpedition to Aramco's weather shack in the 8Z5 zone during May of 1965. In four days of operating, HZ3TYQ/8Z5 contacted 1080 stations in 55 nations. He operated SSB and CW on 3.5, 7, and 14 MHz.

Chalk up two more DX countries through the door to oblivion!

CIRCLE 146 ON READER SERVICE CARD

26 / POPULAR COMMUNICATIONS / March 1986

Please send all reader inquiries directly

THE MONITORING MAGAZINE

Poughkeepsie New York Firefighter A Hero Twice

By all accounts, firefighter Joseph Hatch, Sr. is a mild-mannered and unassuming individual. But as Poughkeepsie Fire Chief James Davison comments, "He's a very dedicated fireman. Although he is very mild-mannered in nature, he becomes a very aggressive firefighter when there's a fire or somebody is in trouble."



Firefighter Joseph Hatch receives Poughkeepsie's Firefighter of the Year award while his wife and children look on. He will also be receiving SCAN's Public Service Award for his heroism. (Poughkeepsie Journal Photo by Craig Ruttle)

SCAN PUBLIC SERVICE AWARD

On two occasions recently firefighter Hatch demonstrated that aggressiveness and his bravery in the line of duty. In one instance he risked his life on an abandoned

railroad bridge, walking on a 4-inch plank, to rescue a man who ventured out on the structure. Hatch was successful in getting the man into a rescue helicopter that had

been sent to the scene. Hatch admits that he is uncomfortable flying. He put any fears aside, however, in this daring rescue.

Later, Joseph Hatch responded to another type of disaster. A fire in an apartment building had trapped a 10-year-old girl and her brother. Hatch carried the girl from the seventh floor burning apartment while a fellow firefighter carried out her brother. Unfortunately, her brother died later, but she owes her life to the heroic action of firefighter Hatch.

Joseph Hatch, Sr. will receive this month's SCAN Public Service Award, which includes a cash award and engraved plaque. SCAN member Robert Marshall of Albany, who made the award nomination, will also receive a special recognition plaque. Congratulations to you both!

SCAN

Our congratulations to this issue's winners of the SCAN photo contest.

Best Mobile Installation

SCAN member Kevin O'Rourke of Elmhurst, Illinois wins this month's photo contest for the best mobile installation. Kevin is an EMT-A and the Communications Coordinator for the Elmhurst Emergency Services and Disaster Agency. The equipment shown is installed in a former police squad car, a Dodge Aspen. Kevin is a member of the Police Car Collector's Association and would like to correspond with other SCAN

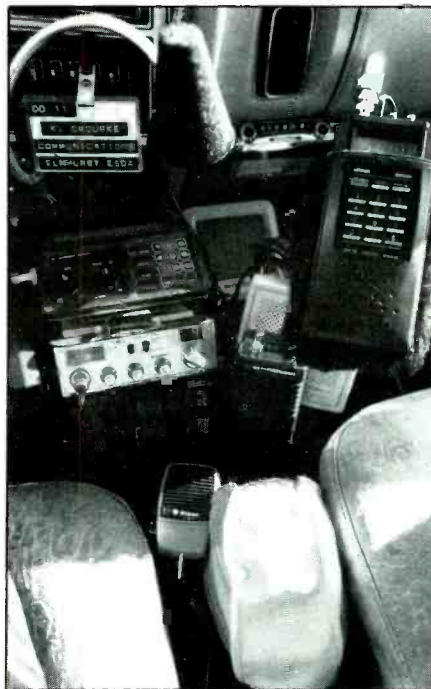

Congratulations to Roland Huff of Columbus, Ohio for this neat looking monitoring installation!

SCAN PHOTO CONTEST WINNERS

members and Popular Communications readers who own squad cars. You can reach him by writing to P. O. Box 324, Elmhurst, IL 60126.

The equipment installed in that Aspen (now with 112,000 miles on it, by the way) is impressive indeed. A Wilson 16-channel VHF Citicom, Federal Signal switchbox (for light and warning device control), Cobra CB radio, Motorola HT-220, and a Bearcat 100XL make up an exceptionally complete communications installation. Congratulations, Kevin! You are a photo contest winner and will receive a Bearcat Alert Warning Radio as your prize.

Best Base Installation

Roland Huff takes this month's prize for a neat and functional base monitoring installation. His Bearcat 250 scanner is hooked up to a BMI NiteLogger and tape recorder to catch all the local activities, even while he is asleep. Roland says that a C-90 cassette is more than enough to capture traffic on five local police channels during midnight hours. In the morning he can quickly review the previous night's activities in a condensed tape listening session.

You Could Win, Too!

Are you proud of your base or mobile monitoring station? We'd like to see it! Just send a sharp black/white photo to SCAN Photo Contest, Box 414, Western Springs, IL 60558. Tell us in a letter about the equipment in the photo and our judges will take it from there. If you win, your photo will be published in *Popular Communications* and you will be eligible for a valuable prize. Send a photo you can spare, because all photos become the property of the Scanner Association of North America and cannot be returned. It's fun to see the installations of fellow monitoring enthusiasts. We'd like to have your entry soon!

SCAN



Eavesdropping On The Soviet Navy



BY HARRY CAUL, KIL9XL

A Large And Active International Naval Presence Requires A Communications Network Of Equal Stature

They (the Soviets) claim that theirs is the largest and most awesome naval force in the world. If that claim is a bit overblown, then their naval force is certainly no worse than holding down second place.

An international military presence of any size requires lots of communications facilities of a wide and varied nature, ranging from HF circuits to those on VHF/UHF—even satellite systems and those relying upon sound waves intended to travel through water, as well as systems using blinking lights and semaphore flags.

The way the Soviet Navy, in particular, is oriented requires a continuing and active reliance upon a technology that was far more popular in the pre-satellite era. Yes, the regular HF bands combined with standard CW mode apparently suit many of their needs quite well, judging from the amount of Soviet Navy circuits operating thusly.

Don't Laugh

This somewhat old-time type of operation, in the era of so-called Star Wars Technology, isn't quite as fuddy-duddy as it might sound at first. The Soviets have long been fully aware of the vulnerability of satellite communications systems when they might come under attack by sophisticated weapons generating laser or high-energy particle beams, or if they should be subjected to the effects of electromagnetic pulse (EMP). Frankly, they haven't overlooked the remote possibilities of a strategic communications satellite system malfunctioning or totally failing from "natural causes" at a critical time.

An unverified story I was recently told notes that someone in our own nation's military communications structure had also come to a similar conclusion and decided that it would be prudent to establish more of an HF backup communications system than presently exists. The attempted implementation of this concept served to painfully point up a rather awful truth—that being our obsession with sophisticated hi-tech communications systems. It had brought about the realization that while there were technicians galore who could design, install, maintain, and service the very latest communications hardware, there was a distinct scarcity of technicians who had an in-depth working knowledge of basic HF communications



BAL'ZAM-Class intelligence collection ships monitor U.S. strategic and general purpose forces; the information is transmitted by radio to Kbiwa and to numerous naval vessels.



KARA-Class guided missile cruisers carry three separate missile systems.



HOTEL II-Class SSBNs carry three SLBMs and eight torpedoes. They are in radio contact with surface vessels.

technology—yes, the voice and CW techniques required to put a homebrewed Ham rig on the air!

A Matter Of Surveillance

Specifically, in the Soviet Navy, there is a requirement for communications systems

used to interface surveillance (spotter) vessels with attack vessels, such as submarines. The submarines, therefore, often cruise on or near the surface in order to maintain communications with the surface vessels providing surveillance.

The surveillance vessels may be major

Soviet Navy

| | | |
|--------|--------------------|--|
| C9C8 | Maputo, Mozambique | 8642 kHz |
| CMU967 | Santiago, Cuba | 5258 6562 6690 6868 8120 8569 10435 10644 10725 10796 11114 11278 11555 14792 14968 15384 15497 17424 18167 kHz |
| COY851 | Havana, Cuba | 13390 kHz |
| COY895 | Havana, Cuba | 7935 9169 10536 11406 14697 kHz |
| COZ67 | Havana, Cuba | 5058 kHz |
| D3L25 | Luanda, Angola | 8642 kHz |
| D3M93 | Luanda, Angola | 16090 16395 kHz |
| RCV | Moscow, USSR | 4264 7574 8576 12723 12744 15465 16492 16498 19098 21764 kHz 12692 18876 20968 kHz |
| RIT | (unknown location) | 5128 5148 6394 7577 8508 8523 9145 9236 |
| RIW | Khiva, Uzbek SSR | 10435 10510 10798 10912 11000 11048 11488 11592 12056 12675 13064 13425 14405 14446 14468 14505 14509 14541 14545 14556 14559 14644 14792 15656 16338 16392 16397 17088 17110 17184 17504 18560 18696 18808 18952 19090 19098 19985 19993 21764 21784 22568 22710 kHz |
| RMP | Rostov, USSR | 8680 10888 11131 12720 16016 16934 18720 kHz |
| ROT | Moscow, USSR | 8456 8500 12995 13045 17130 17155 22450 22454 25130 25175 kHz |
| ROT2 | Moscow, USSR | 6445 17045 kHz |
| UJE | Moscow, USSR | 12967 kHz |
| UMS | Moscow, USSR | 10490 11430 14171 19517 21032 kHz |



Soviet sailors number amongst their ranks plenty of old-style ship "brasspounders." You can hear their CW on your communications receiver.



This hi-tech communications gear, normally embargoed for national security reasons, was seized in the U.S. enroute to the USSR.

warships, such as aircraft carriers, cruisers, frigates, destroyers, etc., or they can be (apparent) scientific research vessels, merchant ships, or fishing industry related craft. The distance between the spotter and attack craft is invariably too great for VHF systems and is well-suited to HF.

HF circuits are also well-suited for reliable primary and/or backup communications with Soviet shore stations located at various points within the USSR, Cuba, Africa, and other areas. Monitors have reported these stations for years, often using standard CW that can be copied by anybody with a regular communications receiver and the mental or mechanical ability to "read" CW.

We have compiled a listing of the Soviet Navy's shore stations and the frequencies that have been noted by North American listeners. There are undoubtedly other stations and other frequencies, but these appear to be the most often noted in CW mode. The ships themselves have been copied on these same frequencies.

Station RIW, in Khiva, is certainly the most omnipresent of all of these stations,

and their transmissions on 14 MHz frequencies always seem to be plentiful.

Our listings here do not include Soviet shore stations that are civilian operated, communicating with merchant vessels of the world in addition to Soviet naval vessels (even though the Soviet merchant fleet is considered by the Soviets to be a part of their naval presence). Our listing consists of shore stations operated by military personnel for purposes of communicating with fleet warships. A roster of Soviet shore stations regularly communicating with nominally merchant vessels appeared in the October '84 edition of *POP/COMM*.

Of course, unless you can comprehend the Russian version of CW (which includes special Cyrillic characters), along with Soviet text and operating codes/abbreviations, most of what you'll copy may not make a lot of sense to you. But, in any event, you'll be able to copy at least the call signs of the shore and ship stations engaged in the contact; that's enough for a valid logging. Now, getting that QSL card is another story altogether!

PC

SE SIGNAL ENGINEERING's High Performance CB Antennas

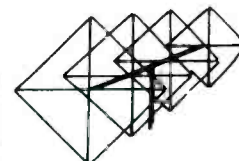

WHITE LIGHTING
\$199.95

SUPERHAWK
\$114.95

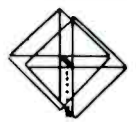

DPX 2000A
\$149.95

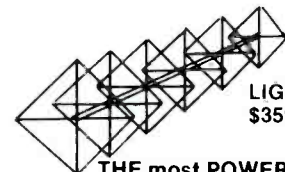
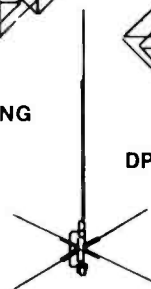

LIGHTNING 6
\$359.95

**THE most POWERFUL
CB base in the world today!**

All SE PATENTED rotary beams are true quads and OUTPERFORM their counter parts (quad/yagi types). SE's patented SFS matching system makes SE QUADS the most technologically advanced antennas in the world today. If your dealer doesn't have SIGNAL ENGINEERING, write or call for full specs. DEALER inquiries invited.

SIGNAL ENGINEERING

2624 Fayette Drive, Mountain View, CA 94040
(415) 948-3833

U.S. Army MARS: VHF Giant

Here's How You Can Monitor This Large Network On Your Scanner

BY PATRICK J. CHICK N8DAQ/AAR5TO
OHIO STATE EMERGENCY COORDINATOR
U.S. ARMY MARS

An extensive VHF repeater network serving northern Ohio, southeastern Michigan, and parts of western Pennsylvania has been assembled by U.S. Army MARS affiliate members to augment their high frequency activity in the respective states. This

system is used to enhance the capabilities of MARS in providing a conduit for emergency communications and to route third party service messages in this tri-state area.

Initiated in 1971 by former affiliate member Roy Polizzi, WA8YEP, now of Hunting-

ton Beach, California and rebuilt and expanded through the efforts of Mr. John S. Papay, K8YSE/AAR5WI, this system provides VHF communications for user stations from north of Detroit, Michigan through the metropolitan areas of Toledo, Cleveland,



Installing an Army MARS receiving antenna 375 feet up; WDLI-TV transmitter tower located in Canton, Ohio. (Photo by John S. Papay, K8YSE/AAR5WI)

Table 1

Subject: Addendum information pertaining to new VHF frequency assignments for eastern area Army MARS

The following table lists frequency, modulation modes, and type of station authorized for use in the VHF frequency band (above 30 MHz) by eastern area Army MARS. Primary and secondary uses are shown as registered with IRAC. Primary use is to be encouraged. Each application involving secondary use is to be specifically approved by MDEA or his designate and in any event secondary use of any frequency is on a non-interference basis to a primary use assignment.

| Frequency MHz | Modulation Mode | Type of Station | Category |
|---|-----------------------------------|-------------------|------------|
| 40.95 | 16F2, 16F3, 16F4 | Repeater Trunking | •Primary |
| | 16F2, 16F3, 0.1A1, 6A2, 6A3 | Fixed Base | •Secondary |
| | 6A3, 16F3 | Mobile | •Secondary |
| 46.79 | 16F2, 16F3, 16F4 | Repeater Trunking | •Primary |
| | 16F2, 16F3, 0.1A1, 6A2, 6A3 | Fixed Base | •Secondary |
| | 6A3, 16F3 | Mobile | •Secondary |
| (this frequency not used within a 100 mile radius of Ft. George G. Meade, MD) | | | |
| 49.79 | 16F2, 16F3, 16F4 | Repeater Trunking | •Primary |
| | 16F2, 16F3, 0.1A1, 6A2, 6A3 | Fixed Base | •Secondary |
| | 6A3, 16F3 | Mobile | •Secondary |
| 49.93 | 16F2, 16F3, 16F4, 0.1A1, 6A2, 6A3 | Fixed Base | •Primary |
| | 6A3, 16F3 | Mobile | •Primary |
| 143.415 | 16F2, 16F3, 16F4 | Repeater Trunking | •Primary |
| | 16F2, 16F3, 0.1A1, 6A2, 6A3 | Fixed Base | •Secondary |
| | 6A3, 16F3 | Mobile | •Secondary |
| 143.990 | 16F2, 16F3, 16F4 | Repeater OUTPUT | •Primary |
| | 16F2, 16F3, 0.1A1, 6A2, 6A3 | Fixed Base | •Secondary |
| | 6A3, 16F3 | Mobile | •Secondary |
| 148.010 | 16F2, 16F3, 16F4 | Repeater INPUT | •Primary |
| 148.650 | 16F2, 16F3, 16F4, 0.1A1, 6A2, 6A3 | Fixed Base | •Primary |
| | 6A3, 16F3 | Mobile | •Primary |
| | 16F2, 16F3, 16F4 | Repeater Trunking | •Primary |
| 150.625 | 16F2, 16F3, 16F4 | Fixed Base | •Secondary |
| | 16F2, 16F3, 0.1A1, 6A2, 6A3 | Mobile | •Secondary |
| | 6A3, 16F3 | Mobile | •Secondary |

General Restrictions: RF power output for all fixed base and mobile stations is limited to 100 watts into the antenna. RF power output for a repeater station should be limited to 100 watts but can, upon specific need and on a case-by-case basis, be approved by MDEA for not more than 300 watts RF output.

Site Locations And Information Ohio/Michigan/Pennsylvania U.S. Army MARS VHF Repeater System

| | | | | | |
|---------|--|---|---|--|--|
| Site #1 | Main Cleveland area transmitter Transmitter outputs | Broadview Hts., Ohio 143.990 MHz 49.930 MHz | Site #9 | Slave repeater output and satellite receiver Transmitter output Receiver input | 148.010 MHz only with VHF link Kingsville/Conneaut, Ohio 143.990 MHz 148.010 MHz with low VHF band link |
| Site #2 | Main receiver site and control hub Receiver input Receiver frequencies | North Royalton, Ohio 148.010 MHz 49.790 MHz | Site #10 | Slave high profile repeater Michigan main transmitter Transmitter output Receiver input | Petersburg, Michigan 143.990 MHz 148.010 MHz only with low VHF link to Ohio |
| Site #3 | Satellite receiver Receiver inputs | Cleveland, Ohio Federal Building 148.010 MHz 49.790 MHz with VHF link | Site #11 | Slave repeater output and Sharpesville receiver site Transmitter output Receiver input | Sharpesville, Pennsylvania 143.990 MHz 148.010 MHz with low band VHF link to Ohio |
| Site #4 | Satellite receiver Receiver input | Mayfield Hts., Ohio 148.010 MHz only with UHF link | <p>Other U.S. Army MARS standalone repeaters in the Ohio, Michigan, and Pennsylvania areas are located in Columbus, Ohio; Red Lion, Ohio (serving Dayton and Cincinnati); Niles, Michigan; Cory, Pennsylvania; Pittsburgh, Pennsylvania; and Mountain Top, Pennsylvania (serving Wilkes-Barre/Scranton). Future plans include a full time link between the master system and the Cory, Pennsylvania repeater, plus a low profile repeater in Newcomerstown, Ohio, with full time links to the master system.</p> <p>Many metropolitan areas throughout the United States have standalone repeaters.</p> <p>All highband repeater outputs are on an output of 143.990 MHz.</p> | | |
| Site #5 | Satellite receiver Receiver input | Chardon, Ohio 148.010 MHz 49.709 MHz with VHF link | | | |
| Site #6 | Satellite receiver Receiver inputs | Mansfield, Ohio Ohio Air National Guard 148.010 MHz 49.790 MHz with VHF link | | | |
| Site #7 | Satellite receiver Receiver inputs | Canton, Ohio WDLI-TV 148.010 MHz 49.790 MHz with VHF link | | | |
| Site #8 | Satellite receiver | Warren, Ohio located at Howland Corners, Ohio | | | |

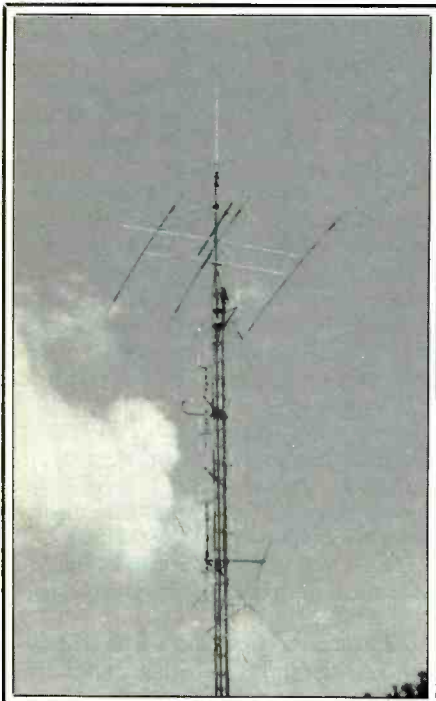

Army MARS main control point for Cleveland and 148.01/49.79 MHz receiver site. This tower is 105 feet high. (Photo by John S. Papay, K8YSE/AAR5WI)



Main Cleveland area repeater antennas cover frequencies 143.99 MHz and 49.49 MHz. This water tank is 174 feet above ground. (Photo by Patrick J. Chick, N8DAQ/AAR5TO)

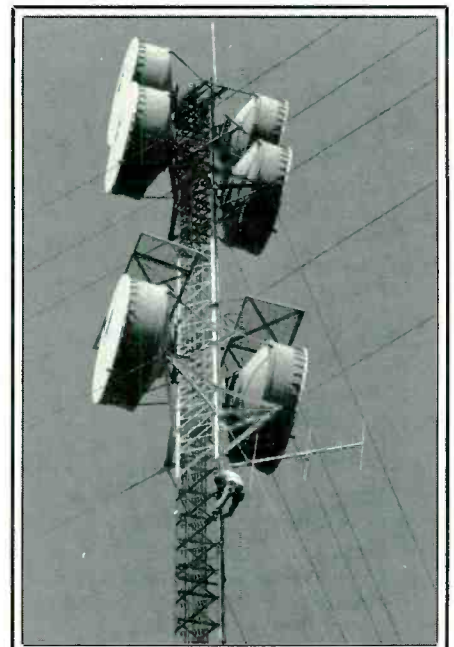

Army MARS member Ed Kaleta (AAT5IA) installs a 49.79 MHz link antenna on an M.C.I. tower in Petersburg, Michigan. An Army MARS 143.99 MHz repeater antenna is at the top of this tower. (Photo by John S. Papay, K8YSE/AAR5WI)

"INSIDER'S INFORMATION"

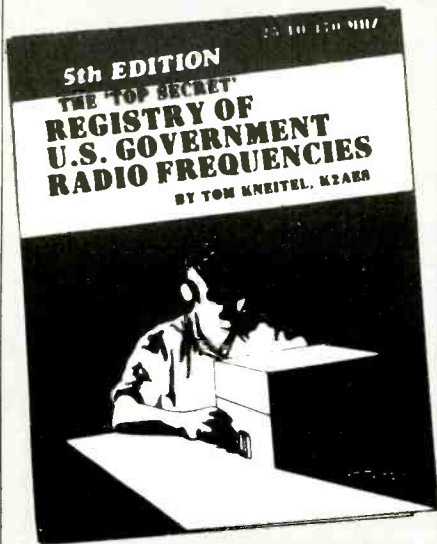

Since 1967, CRB Research has been the world's leading publisher and supplier of unique hobby and professional books and information including:

- Scanner Frequency Guides
- Shortwave Frequency Guides
- Military/Federal Communications
- Broadcast Station Registries
- Undercover Communications
- Survival Communications
- Covert Operations
- Electronic Espionage
- Surveillance
- Monitoring
- Cryptography & Codes
- Bugging
- Wiretapping
- Communications Antennas
- Electronics & Projects
- Authentic Combat Communications Cassettes
- Computer Technology
- & Other Related Topics!

New titles are constantly being added to our exciting catalog. If it's interesting and unusual, we've got it. You'll see! Ask for our latest FREE catalog!

CRB RESEARCH
P.O. Box 56 Commack, NY 11725

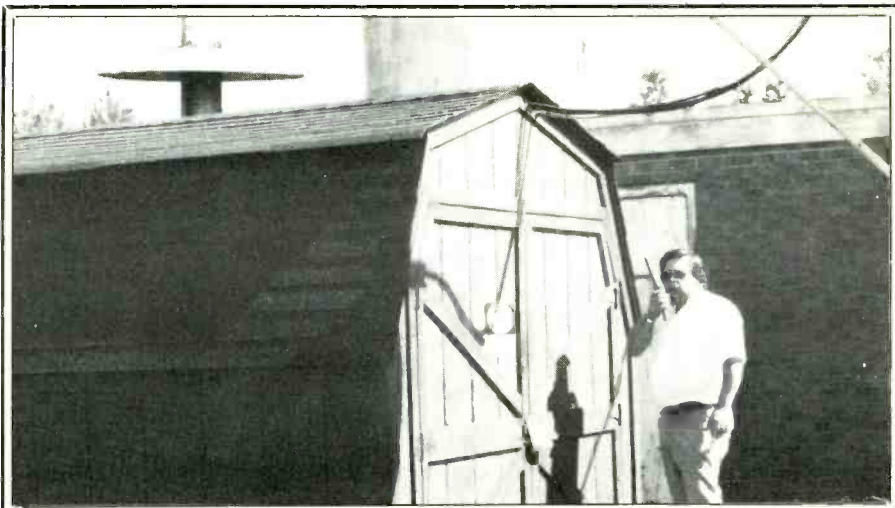

Pat Chick uses HT-220 to talk to Monroe, MI 125 miles away. The barn houses the 143.990 and 49.930 MHz main Cleveland transmitter. (Photo by Alex Voloshen, K8LXE/AAR5XK)

and Akron, Ohio, extending northeast to Erie, Pennsylvania and east to the Sharon/Sharpesville, Pennsylvania area.

Monitors within this geographic area can easily hear base, mobile, and even handheld portable operations from any of these Metro-areas by listening to the system outputs on 143.990 MHz and 49.930 MHz.

Communications consist of voice operations in both formal net format and casual conversation, and, from time to time, intra and interstate radioteletype traffic. Teletype

is sent at a standard 60 wpm Baudot rate, 170 Hz shift. As many as 25 individual 24 hour autostart stations stand by on the system, including the Cleveland and Barberton Ohio Chapters of the American Red Cross, plus Ohio National Guard station AAR5USK in Barberton, Ohio.

Built totally with non-government support, funds are supplied by volunteer members and surplus equipment donated by local utilities and communications outlets. The system provides the most extensive coverage on VHF of any Army MARS system in the continental United States (CONUS).

Individual repeater/receiver site locations are provided by the State of Ohio, M.C.I., Public Television, The David Livingston Ministry, The G.S.A., a private communications firm and private affiliate MARS members.

Aside from normal everyday activities, use provides support of the Ohio National Guard, American Red Cross, and other disaster agencies.

Typical operations include communications support for such drills and actual events as the November 1984 Nuclear Evacuation Test for the Perry Nuclear Power Plant in Perry, Ohio and health and welfare messages during a May 31, 1985 disaster when deadly tornados completely devastated parts of northeastern Ohio and western Pennsylvania.

Reception of this system is quite easy in most of the coverage area using a quality programmable scanner without an elaborate monitor antenna system due to the multiple transmitter outputs on 143.990 MHz.

The 49.930 MHz output may be heard in many other parts of the country as propagation permits.

Verification of reception will be acknowledged when reports are accompanied by a self-addressed stamped envelope.

Send QSL information to: U.S. Army MARS Station Director, AAR5TO, 1340 Lander Road, Mayfield Heights, Ohio 44124-1606. **PC**

Don't Settle For Less, Run The Best

5 STAR
SPECIFICATIONS:
TYPE
Horz. & Vert. Polarization Twin Feed Line
GAIN
16.5 DB
FRONT - BACK RATIO
48 DB True
SIDE REJECTION
50 - 55 DB True
BACK REJECTION
40 DB True
WEIGHT
37 Pounds
LENGTH
17 Feet 6 Inches
HORZ. - VERT. SEPARATION
25 - 30 DB
WIND SURVIVAL
100 MPH+
POWER MULTIPLICATION FACTOR
65
AUDIO GAIN
22 DB



Super Audio 6
SPECIFICATIONS:
TYPE
Horizontal (Flat)
GAIN
20 DB
FRONT - BACK RATIO
55 DB
SIDE REJECTION
55 - 60 DB
BACK REJECTION
50 DB
WEIGHT
45 Pounds
LENGTH
28 Feet
WIND SURVIVAL
100 MPH+
POWER MULTIPLICATION FACTOR
90X
AUDIO GAIN
30 DB

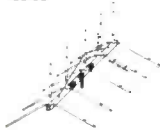

"STAR" SERIES
JG 5 + 5 Star



"SUPER AUDIO" FLAT SERIES
JG SA-6 Flat

"The Antenna Built For The CB'er Who Demands The BEST In PERFORMANCE And QUALITY"

AVAILABLE IN VARIOUS SIZES & MODELS

Call or Write **Jo Gunn Enterprises**
For More Route 1 - Box 383
Information: Ethelsville, AL 35461
(205) 658-2595
HOURS: MON. - FRI. 9 AM - 5 PM (CST)

BOOKS YOU'LL LIKE!

BY R.L. SLATTERY

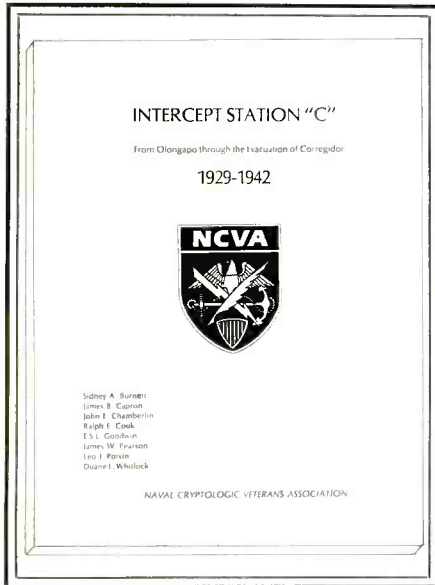

Intercept Station "C"

We have found an exciting 83-page large (8½" × 11") format book discussing the exploits of a hardy band of U.S. Navy communications monitoring experts during the worst days of WWII.

The book, entitled *Intercept Station "C"*, begins with a fascinating history of the intercept unit, which was formed in 1929 aboard the *USS ISABEL*, possibly the first floating communications intercept platform. Through text and photos, it traces the mission of the unit to 1942, when they were located on Corregidor Island in the Philippines. These men, performing one of the most intriguing and important jobs of the Pacific Theatre, were tuned in on (and were unravelling) the enemy's highly complex secret code transmissions. It was a miracle that they were able to be evacuated by submarine just before Japanese forces stormed their secret communications center.

The story was put together from personal interviews with those who served in this intercept unit. Additional information was obtained from official U.S. Navy documents released by the government. Official Navy photographs are augmented by many personal photos taken by those involved. There are also memos and the texts of other official documents included. A listing of all personnel (and their ratings) is provided.

From the first days of the unit, aboard the *USS ISABEL*, right up to the daring escape from Corregidor aboard the *USS PERMIT* (SS-178), those who worked in this hush-hush unit were performing the type of duty that is guaranteed to bedazzle anybody and everybody interested in communications and cryptography. Unfortunately, until recently, what they were doing and how they were doing it remained unheralded and al-

most unknown outside of the official inner circles of naval communications.

You like shortwave? You'll like this book, especially since every single word of it is true—most of it in the words of those officers and men who worked at OP-20 (a/k/a *The On-The-Roof-Gang*).

Intercept Station "C" is available at \$6.50 per copy (postpaid) from the Navy Cryptologic Veterans Association, 593 Clarmar Drive N.E. Salem, OR 97301.



Rating The Receivers

Communications Engineer Rainer Lichte has done a fine job with his new book, *Radio Receiver—Chance or Choice*. What he's done is assemble a huge array of contemporary communications receivers from the world's leading manufacturers (ICOM, Panasonic, Magnavox, R.L. Drake, Sanyo, Sony, JRC, Trio-Kenwood, Uniden/Bearcat, Yaesu, GE, and many more) and test all of them. Thus, Lichte has made it easy for the communications enthusiast to get an overview of the specs and performance ratings of receivers in all price ranges and degrees of sophistication—including portables.

He has put each and every piece of equipment through a complete battery of intensive tests, using precision lab gear. He compares his test results with the manufacturers' published specs, sometimes offering additional specs not provided by the manufacturers. Lichte then tells of the sets' strong and weak points, based upon his own observations while the units were in actual use. His language is straightforward and easy to understand even if you don't have an engineering degree, and his opinions are frank and honest. If he doesn't like something, he doesn't beat around the bush; he comes right out and says so.

This is a hefty book of 256 pages, filled with photos and charts. Best of all, it's just about everything you'd want to know about the current state of receiver technology for the hobbyist—it's all in one place, it's concise, it's honest, and it's done in-depth. We liked it and think that you'll also like it.

This book is available at \$18.50 per copy plus \$1.50 postage (USA/Canada) from Gilfer Associates, Inc., P.O. Box 239, Park Ridge, NJ 07656.

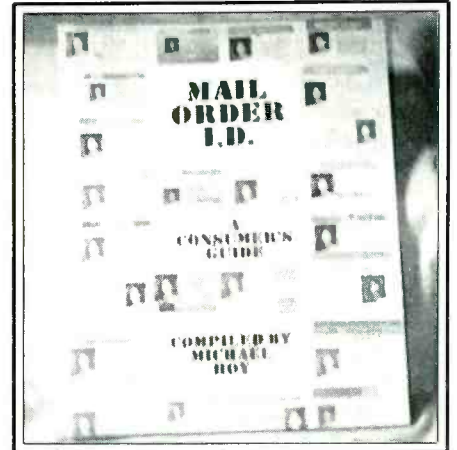

Calling All Agents

Michael Hoy has spent an enormous amount of time compiling a very exhaustive guide to all of the I.D. cards and other personal documents you can obtain through the mail (with no questions asked).

Complete names/addresses of many suppliers, plus prices and more than 200 photos of the cards and documents available from various suppliers offering: photo I.D. cards, drivers' "licenses," state I.D. cards, student I.D.'s, diplomas of all types, baptism certificates, Social Security cards, press cards, union membership cards, birth certificates, Canadian I.D. cards, badges and police I.D.'s, and lots more!

Hoy's large format 108-page illustrated book is a spectacular and gigantic source of information for security personnel, law enforcement agencies, paper trippers, and anybody else looking for information on the most authentic-looking I.D. documentation we have ever seen, plus information on the laws relating to the stuff.

We never realized the extent that this material was so readily available, nor did we have any idea that the quality had become so classy. It is a very far cry from the days when folks were making photocopies of birth certificates and changing them with an eraser and a typewriter!

Mail Order I.D., by Michael Hoy, is available at \$14.95 per copy, plus \$1 postage/handling (to USA/Canada/APO/FPO) from CRB Research, P.O. Box 56, Commack, NY 11725. **PC**

A One-Tube DX Dynamo!

MW DXing With An Antique Radio – It Can Be Done!

BY ED NOLL, W3FQJ

DXing was a hobby for at least one member of each radio family in the 20's of this radio century. Indeed there were more MW DXers than now. I have spent the last several weeks bringing such a 20's radio back to life, and doing a little bit of old-time DXing by learning to cope again with regeneration control settings and the frustrations of hand-capacity effects when tuning in distant stations. Table 1 shows the results for the first two evenings of listening for just one setting of the two switches associated with an old time variocoupler that links the aerial with the grid circuit of the single tube 20" x 10 1/2" x 10" radio. Since then I have tuned in many more stations and have stretched the distance to WWL New Orleans, KMOX St. Louis, and WHO Des Moines, despite summer reception conditions. KFI be aware!

The one-tuber was discovered at a flea market. When I opened the lid and saw the single 01A tube and all the electronic trappings of 60 years ago, my eyes must have glowed as brightly as the early tube itself. There were three headsets nestled in the corner and attached to a single brass plug with enough insulated set screws to parallel four pairs of headsets. I could visualize the family sitting around the dining room table listening to early evening programs. Long after others had gone to bed, there sat the lone DXer of the group with ears focused on those far-away signals.

I dickered for a more reasonable price, but the merchant was much too aware of my enchantment. Reluctantly I moved away to seek out my wife, Dottie, to go in as a reliever. Her pleasant chatter, which often wanders away from the subject, broke through and she came away with the big box.

The radio does not have many parts, but can reach out for distant signals. No wonder early radio amazed almost everyone. It amazes me today. A schematic diagram of the one-tuber is given in Figure 1. A brief description and purpose of the parts follows.

Variocoupler The variocoupler, along with the two condensers (capacitors today) and the antenna system, form a resonant circuit that results in maximum signal current when tuned to the frequency of the received

| | | |
|------|------|----------------------------|
| CJSB | 540 | Ottawa, Ontario |
| WFIL | 560 | Philadelphia, Pennsylvania |
| WIP | 610 | Philadelphia, Pennsylvania |
| WNBC | 660 | New York, New York |
| WYIS | 690 | Phoenixville, Pennsylvania |
| WLW | 720 | Cincinnati, Ohio |
| WOR | 710 | New York, New York |
| WVCH | 740 | Chester, Pennsylvania |
| WJR | 760 | Detroit, Michigan |
| WABC | 770 | New York, New York |
| WBBM | 780 | Chicago, Illinois |
| CKLW | 800 | Windsor, Ontario |
| WTMR | 800 | Camden, New Jersey |
| WGY | 810 | Schenectady, New York |
| WHAS | 840 | Louisville, Kentucky |
| WTEL | 860 | Philadelphia, Pennsylvania |
| CHML | 900 | Hamilton, Ontario |
| WPEN | 950 | Philadelphia, Pennsylvania |
| KYW | 1060 | Philadelphia, Pennsylvania |
| WGHW | 1110 | Philadelphia, Pennsylvania |

Table 1: First logging with antique radio.

station. The resultant signal voltage appears on the grid of the tube. The variocoupler in my receiver has a fixed coil with seven taps at the top of the winding separated from each other by one turn and seven taps beginning at the bottom separated by seven

turns. Suitable taps are chosen according to the frequency range to be tuned and the antenna characteristics. In practice, though, you experiment with the tap positions to obtain the best results for the antenna you use and frequency range to be received. The

Figure 1: Original circuit of antique radio.

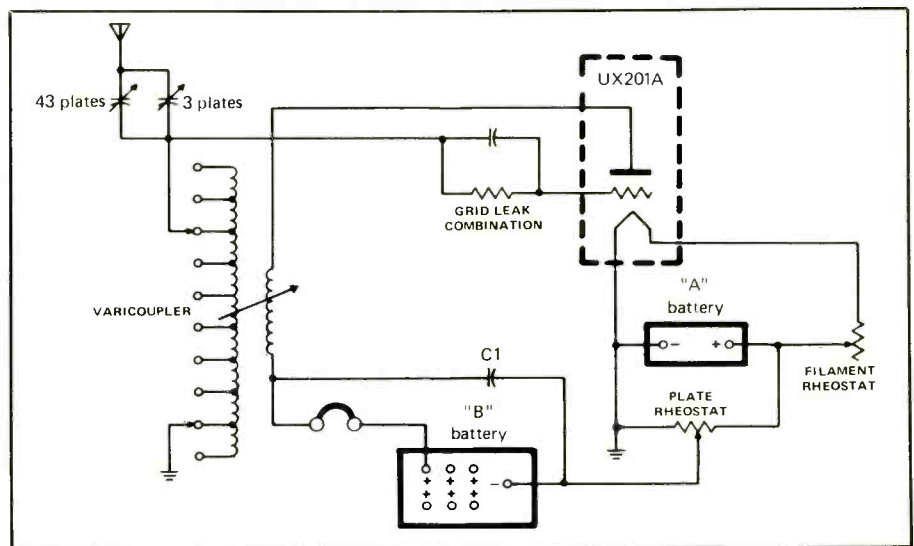

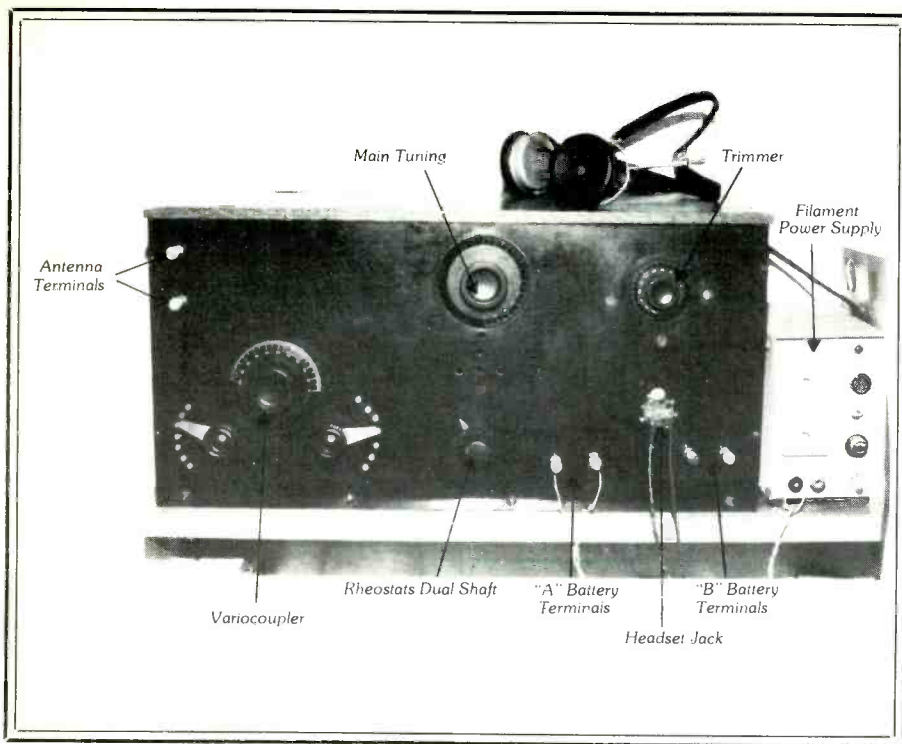

Antique one-tube radio and modern filament power source.

variocoupler has a second coil that rotates and is adjusted for maximum output and whether you wish the regenerative detector to oscillate or not. More on this later.

Variable tuning condenser This condenser is used to tune the receiver from station to station and has an associated dial that is calibrated from 0 to 100, however, you have no station calibration because the location of the stations on the dial depend upon antenna and variocoupler taps that are used. The old timer, when he used his receiver with his antenna, first located the best tap

positions and then made up his own little calibration chart to help him locate the stations he wished to receive. Often, two or more combinations were used that would give him the best results for the signals he wished to receive according to their frequencies. Many times this was done in a most haphazard way and users did not obtain the full sensitivity that the receiver was capable of delivering.

Variable band-spread condenser This small, three plate condenser was a fine tuning control. It was of assistance in tuning

in a desired station carefully and was especially useful in tuning in a high-frequency station because they were crowded together at the one end of the tuning dial of the main variable condenser.

Triode tube The single tube of the receiver has three elements: grid, plate, and filament. The filament is heated and releases electrons that move toward the plate because of the attraction by the positive voltage on the plate. However, the control grid structure is located between the filament and the plate. The signal voltage applied to the grid from the variocoupler varies the electron current, which then results in an amplified signal voltage on the plate. However, the electron current flow in only one direction and rectification or detection occurs, and just like modern diode detectors, any audio modulation on the incoming signals is recovered and heard in each of the ear pieces of the headset.

There is also a feedback path for the radio energy at the plate to the rotatable winding of the variocoupler. This regenerative path resulted in a further amplification of the received signal. The amount of feedback is controlled by changing the relative position of the rotating coil with respect to the fixed coil.

When aligned at the same angle, there is maximum transfer. When coil is perpendicular to the fixed coil, there is minimum feedback or regeneration.

As you tune your receiver for reception, the setting of the rotating coil is important in obtaining the strongest output as related to the frequency of the signal being received, as well as its strength. If there is too much feedback, the circuit self-oscillates. This method of operation is used in the reception of CW signals and obtaining the maximum sensitivity in the reception of a very weak

Close-up of multi-headset jack and 0.05 capacitor and headset leads across two pairs of terminals.

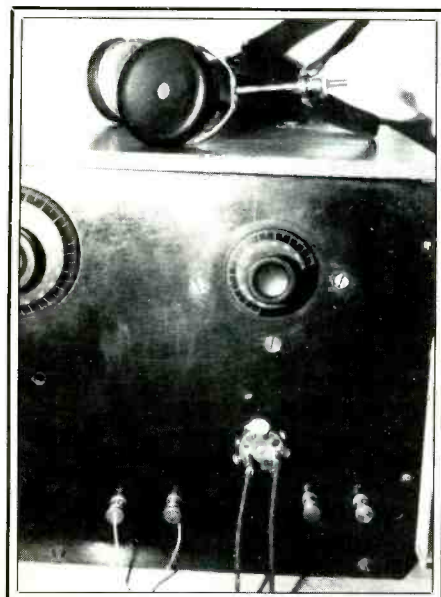

Close-up of variocoupler, main tuning condenser and tube.

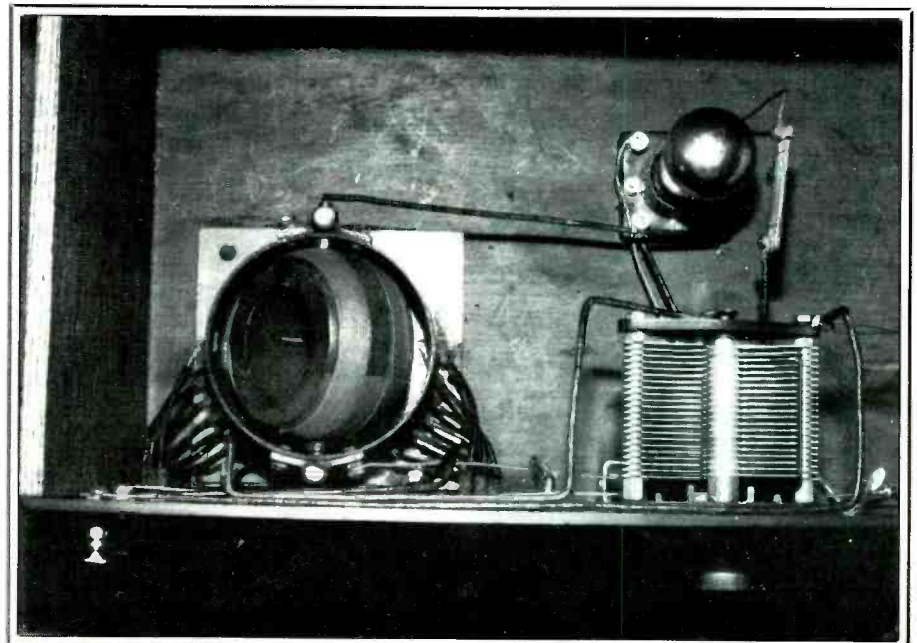

Free Catalog Features Hard-To-Find Electronic Tools

Page after page of hard-to-find electronic tools and test equipment. Also contains a complete line of tool kits and tool cases. Send for your **free** copy today!

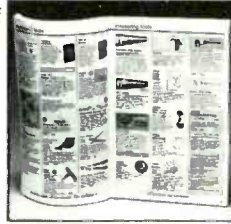

JENSEN TOOLS INC.
7815 S. 46th St. Phoenix, AZ 85044
(602) 968-6241

CIRCLE 132 ON READER SERVICE CARD

Shortwave Receivers, Antennas

ICOM - KENWOOD - YAESU Etc.

Call 212-925-7000

Open 7 days a week, Mon.-Fri. 9am-6pm,
Thurs. until 8pm, Sat. & Sun. 10am-5pm

Barry Electronics

512 Broadway • New York, NY 10012
Sales & Service Ham & Commercial Radio
For 35 Years

Please send all reader inquiries directly.

CB MODIFICATIONS

Increase channels, range, privacy! We specialize in frequency expanders, speech processors, FM converters, PLL & slider tricks, how-to books, plans, kits. Expert mail-in repairs & conversions. Free 16-page catalog.

CBC INTERNATIONAL, P.O. BOX 31500PC,
PHOENIX, AZ 85046 (602) 996-8700

Please send all reader inquiries directly.

Scanners, CB Radios Radar Detectors

COBRA BEL FOX UNIDEN WHISTLER FZFBUSTER
UP TO 50% OFF
ALL BRAND NEW WITH WARRANTY NAME BRAND ELECTRONICS **FREE PRICE LIST**

MasterCard
VISA

RADAR DETECTORS • CAR STEREOS
CORDLESS PHONES • CB'S • SCANNERS
ANSWERING MACHINES • MARINE RADIOS

COMPUTRONIX, 815 MILWAUKEE
GLENVIEW, IL 60025 / 312-729-BUYS

CALL TOLL FREE FOR PRICES **1-800-237-BUYS**

VISA • M.C. • AMEX • PERSONAL CHECKS • 1 WEEK DELIVERY!



The magazine for Computerist & Amateur Radio
Your #1 source of Packet info.

"... received my moneys worth with just one issue ..."

—J. Trenbick

"... always stop to read CTM, even though most other magazines I receive (and write for) only get cursory examination ..."

—Fred Blechman, K6UGT

U.S.A. \$18.00 for 1 year
Mexico, Canada \$32.00
Foreign \$43.00 (land) - \$68.00 (air)
(U.S. funds only)
Permanent (U.S. Subscription) \$150.00
Sample Copy \$3.50

CHET LAMBERT, W4WDR
1704 Sam Drive • Birmingham, AL 35235
(205) 854-0271

CIRCLE 133 ON READER SERVICE CARD

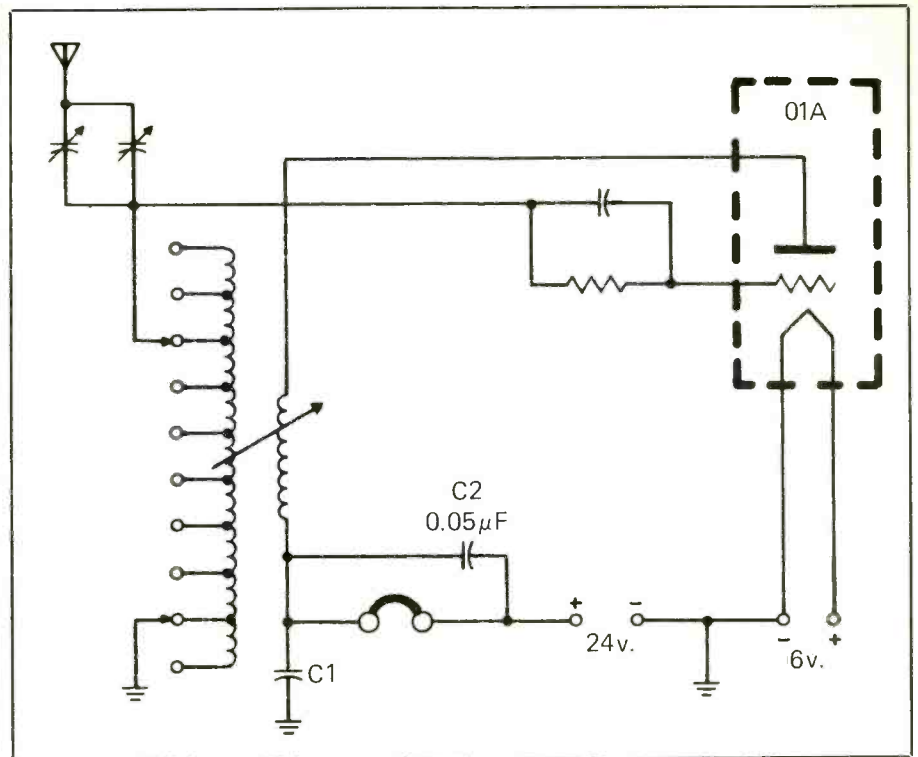

Figure 2: Antique radio circuit as modified.

broadcast signal. When the tube self-oscillates, it also acts as a miniature transmitter and can be heard around the neighborhood. Thus, when user and neighbor both tuned to the same weak signal, there was a lot of squealing going on and was often a cause for some heated discussions among neighbors in those good old days.

Grid leak resistor/condenser This combination resistor and condenser had an influence on the biasing and efficiency of the reception and demodulation of the signal supplied from the variocoupler. Sometimes the two parts were built into the same package. In operation, electrons collected on the control grid of the tube and they were able to leak off through this pair of parts. Such is necessary to prevent blocking of the tube and hence the name grid leak. Avid DXers of those days would often experiment with these two values to obtain the very best performance in the reception of weak signals.

Plate bypass condenser Condenser C1 provided a low impedance path for the radio frequency signal as explained in the old text books. However, it really functions as a filter for those frequencies permitting the detector to follow the audio variations that are present on the incoming signal and which you wish to hear in the headset.

Headset Each earpiece of the headset consists of an electromagnet and a diaphragm. As the audio current varies in the electromagnetic coil, the diaphragm vibrates and permits you to hear the recovered audio signal.

"A" Battery This battery supplied the 6 volts required by the filament winding of the tube. The resultant battery current flow heated the filament so it would emit electrons.

Filament rheostat This variable resistor permits a control of the filament current and could possibly prevent the application of too high a voltage to the filament. Too high a filament voltage could result in an early burn out of the tube's filament.

"B" Battery The "B" battery supplied the plate voltage for the tube. In those days the radio "B" battery often had a number of positive taps. Connection could be moved about to obtain the best signal and performance from the receiver. Also, the position was changed as the battery aged.

Plate rheostat This rheostat was a control of the plate voltage and was also adjustable to obtain the most favorable operating conditions. Note that it was even connected to the arm of the filament rheostat so as to obtain some benefit (very limited) from the "A" battery. This connection of rheostats and batteries, along with the possibility of connecting the batteries with incorrect polarity, often resulted in the unexpected demise of the tube. Do you remember?

Hardware There are, of course, a variety of hardware components—including terminals, dials, and headset jacks.

Shaping Up The Receiver

My antique radio was a homebrew one. It was hand-wired and there was no soldering. Squeeze connections or screw terminals were used throughout. The only soldered connections were associated with the variocoupler and these joints were made where the variocoupler was manufactured. The average home did not have an electrical soldering iron or even a soldering pot. As a country kid I remember my first soldering tool was a tinsmith iron stuffed into the hot

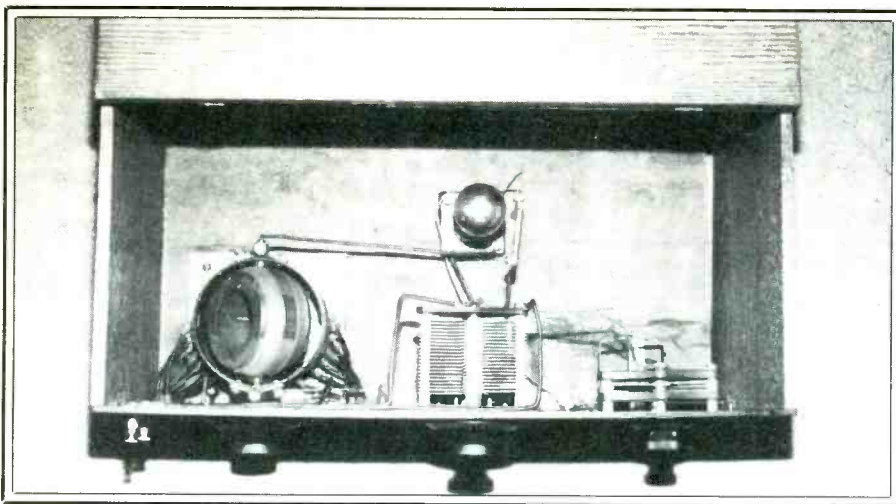

A look inside, lid open showing variocoupler two condensers and tube.

coals of the kitchen stove. Then I would run upstairs with the hot iron to make a few soldered connections.

Actually, the only reason the antique receiver did not operate initially was bad connections. Once they were found, the receiver came alive. I did not change the receiver in any way, preferring to leave it as it was originally. However, I disconnected the two rheostats, leaving them in place in the receiver. Proper voltages could be supplied externally to the "A" and "B" battery terminals (Refer to Figure 2). I added one capacitor (C2) by connecting it across two of the terminals of the headset plug. These terminals were available because I needed only one headset. This capacitor of high value improved the demodulation efficiency and resulted in a much stronger headset signal. The 24 plate volts were supplied by two 12-volt lantern batteries connected in series (Eveready number 732). The 6 volts for the tube filament are supplied by a regulated transistor power supply. Filament current requirement for the 01A is about 1/4 ampere.

A long antenna is important if you wish to do MW DXing. If reception of local stations is as far as you wish to go, a much shorter one will do. A long antenna is especially important if you wish to do some DXing at the low-frequency end of the broadcast band. It is the wire length that seems to be important rather than the actual area occupied by the antenna. My results have been excellent, with a 240' length of hook-up wire laced back and forward among the beams of the crawl space above my single-floor dwelling. A 135' long wire outdoor antenna does fine over half of the band, but results being to fall off at the low frequency end as compared to the crowded 240' in the crawl-space. I use a cold-water pipe ground.

Patient Tuning

A regenerative detector responds well to strong and weak signals. There is no great problem in tuning in a strong signal and audio output level is indeed surprising for a one-tube radio. Weak signals can be made

to come in clearly with patient tuning. Much depends on the proper settings for the tuning control and regeneration control (rotating coil of variocoupler).

The regeneration control in tuning in a moderate to strong signal is advanced just to the point at which the receiver goes into self-oscillation, as made evident by regenerative rush plus squeals when you tune near a station; then back off the control just to the point at which it goes out of self-oscillation. Readjust tuning control slightly for maximum output. In general, to reach near to the self-oscillation point, a higher setting of the regeneration control is required as the tuning control is advanced to tune in lower-frequency signals.

A weak signal requires more patience, especially when you are trying to ID a very weak signal that will produce no output when the circuit is not self-oscillating. First, set the regeneration control just to the point of self-oscillation over the approximately 50 kHz range you plan to tune in searching for DX signals. You tune in any such signal by zero-beating it. When it is very weak, you must jockey back and forth between tuning and regeneration controls for the very best signals. The rub, though, is hand-capacity effect. When you move your hand away from either control, you lose the exact zero beat and the set squeals—so you must develop the fine technique of tuning just slightly (ever so slightly) low in frequency. Hence, when you move your hand away from the dial, the tuning will rise (hopefully) in frequency to the exact zero beat. It can certainly be a bit frustrating at times, but DXing with a 60-year-old radio can take each of you back to the early days of radio broadcasting.

A few labels were located on some parts. If you know anything about Simplex Radio Company Philadelphia, Freed-Eisemann Radio Corporation New York, Bright and Company Reading, Pennsylvania, or Hamburg Brothers Pittsburgh, Pennsylvania, please send a note to me. I am interested in digging out some past history of these companies to better determine the age of the radio. PC

FREE SATELLITE TV



800-4-SATMAN



NEW 24 Page Buyer's Guide With Guaranteed Lowest Prices

- Explains all about FREE 100 channel Satellite TV and how to shop for an earth station!
- Lists GUARANTEED LOWEST PRICES...we will not be undersold, save 30-50% over local dealer prices!
- Tells how to easily and quickly Install-Your-Own earth station and save \$400 or more!
- Shows how to demonstrate and sell earth stations from your home and earn extra money!

uniden
ALCOA

Panasonic
CHAPARRAL

www.satman.com
DRAMA
Amplex, Inc.

The new SATMAN Buyer's Guide is a *necessity* for any prospective or current earth station owner who wants to save big money on name brand satellite products and also earn some extra money. Buy direct, Do-It-Yourself, and save with SATMAN. Toll free ordering, no sales tax (IL only), major credit cards accepted, huge in-stock inventories available, and fast UPS shipping anywhere in U.S. Check with SATMAN before you buy...*We will not be undersold!* Call now for your free 24 page SATMAN Buyer's Guide.

1-800-4-SATMAN

1-309-692-9582 Illinois



5017 N. MELODY • PEORIA, IL 61614 • 1-800-4-SATMAN

clip and save

Please send all reader inquiries directly.

BETTER SIGNALS

BY ED NOLL, W3FQJ

ANTENNAS AND SIGNAL IMPROVING ACCESSORIES

A single-wire end-fed longwire can be adapted to MW as well as SW reception. In the *POP'COMM* January '86 column, end-fed wire and tuner combinations were detailed. An additional antenna length added to the 120' version can offer further improvement in MW reception. As such, there is no longer a specific need for a tuner. Information on some special MW arrangements follow.

The basic plan of a good SW/MW combination is shown in Figure 1. Note that an additional wire length is added to obtain a total length of 300', which corresponds to an approximate quarter wavelength on 780 kHz. As shown in Figure 2, the antenna is supported by PVC piping. Wire is run through eye-ring bolts mounted at the mast top. The stretch out of the wire is pulled up at the fence post support at the far end.

The jumper arrangement can be made convenient by dropping two wire ends down to easy-reach level on one of the masts, as shown in Figure 3. Disconnect one side of the jumper and you have a 120' end-fed longwire, which may do better in some segments of the shortwave spectrum than full length. Jumper connected you have a good MW performer, a big help in IDing those weak signals. Don't forget that the antenna wire need not be stretched out in a straight line if you don't have the space. Stretch it out as much as you can to occupy whatever area you have available.

You graveyarders and high-end band searchers may wish to keep your long wire at this end of the band. A wire length of 165' corresponds to a quarter wavelength at about 1400 kHz. The arrangement of Figure 4A shows the addition of a second jumper. With first jumper closed and second opened, you favor the graveyard end of the band. With both jumpers closed, you favor the low end of the band down to 540 kHz. Figure 4B shows how to do it if you are planning the antenna for MW use mainly. A single jumper permits you to split bands into two MW sections.

Fall/Winter 85/86 MW Aerial

Our own 85/86 MW season aerial based on the previous ideas is shown in Figure 5. Separate low-end and high-end antennas were erected, with most of the length of each running due west. Of course, this is the best consistent DX direction from my eastern Pennsylvania location. By so doing, best advantage is taken of the off-end directivity of a longwire. The two radiator ends of the antennas terminate at the two inner conductors of a two-position coaxial switch. At-

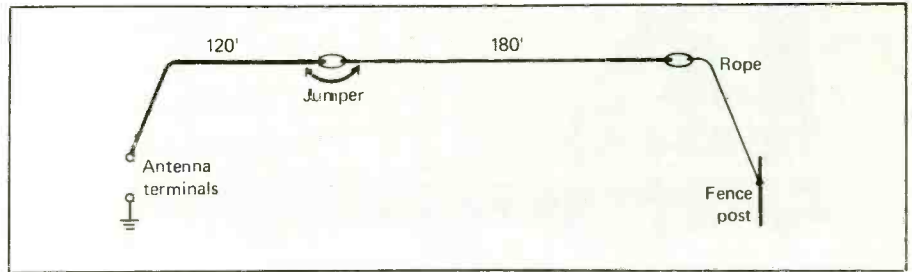

Figure 1: Plan for medium wave addition to 120', 2-30 MHz end-fed longwire.

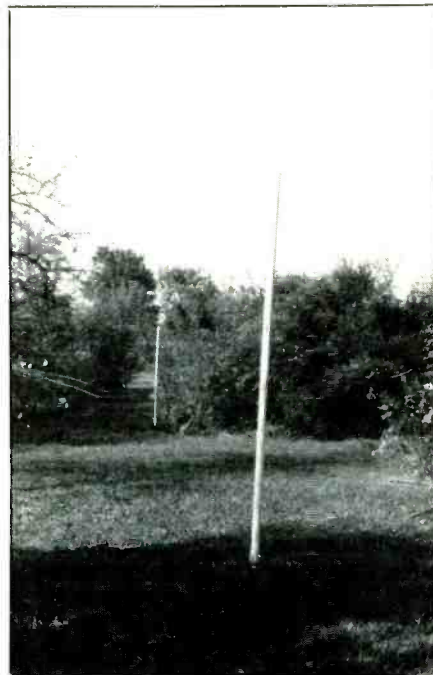

Figure 2: Suspend end-fed longwire with PVC pipes spaced 50-60 feet apart.

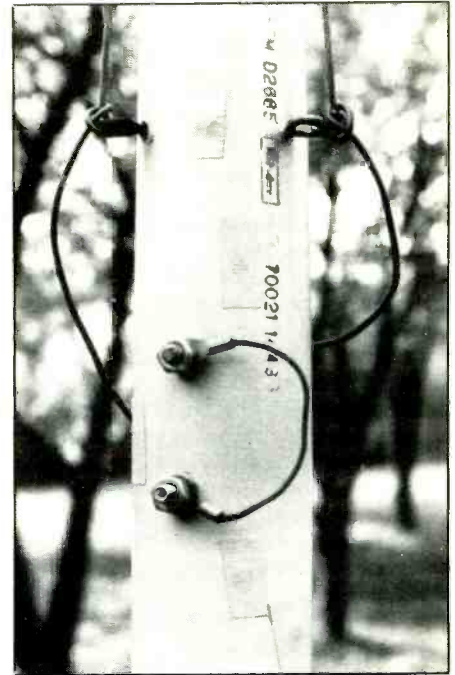

Figure 3: Easy-reach position of jumper.

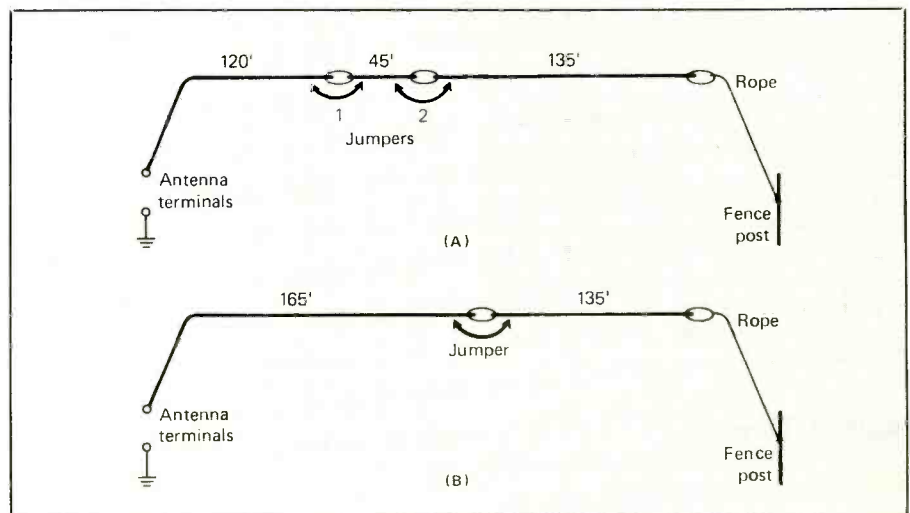

Figure 4: Two MW Jumper Plans: (A) SW-MW (low)-MW (high); (B) MW (low)-MW (high).

**Long to Short
Wire
S-Unit
Difference**

Section 1

540-740 kHz Segment

| | | | | |
|---|------|---------|------------------|----|
| N | WARM | 590 kHz | Scranton, PA | +5 |
| E | WNBC | 660 kHz | New York, NY | +8 |
| S | WIP | 610 kHz | Philadelphia, PA | +8 |
| W | WHP | 580 kHz | Harrisburg, PA | +8 |

Section 2

750-950 Segment

| | | | | |
|---|------|---------|------------------|----|
| N | WGY | 810 kHz | Schenectady, NY | +5 |
| E | WTTM | 920 kHz | Trenton, NJ | +2 |
| S | WPEN | 950 kHz | Philadelphia, PA | -1 |
| W | WEEU | 850 kHz | Reading, PA | +6 |

Section 3

960-1160 Segment

| | | | | |
|---|------|----------|------------------|----|
| N | WGPA | 1100 kHz | Bethlehem, PA | -1 |
| E | WINS | 1010 kHz | New York, NY | +1 |
| S | KYW | 1060 kHz | Philadelphia, PA | -3 |
| W | WHYL | 960 kHz | Carlisle, PA | +3 |

Section 4

1170-1370 Segment

| | | | | |
|---|------|----------|------------------|----|
| N | WKAP | 1320 kHz | Allentown, PA | -5 |
| E | WBUD | 1260 kHz | Trenton, NJ | -2 |
| S | WHAT | 1340 kHz | Philadelphia, PA | -6 |
| W | WHUM | 1240 kHz | Reading, PA | +3 |

Section 5

1380-1600 Segment

| | | | | |
|---|------|----------|------------------|----|
| N | WEST | 1400 kHz | Easton, PA | -7 |
| E | WBCB | 1490 kHz | Levittown, PA | -4 |
| S | WDAS | 1480 kHz | Philadelphia, PA | -6 |
| W | WLAN | 1390 kHz | Lancaster, PA | -1 |

Table 1: Long to short antenna signal comparisons

tach a banana plug to the end of each wire for insertion into the inner conductor of the coaxial jacks of the switch. A short, single wire connects the output of the coaxial

switch to the single-ended antenna input of the receiver. Use a good ground on the receiver, preferably a cold water pipe. Any good single-pole double-throw switch will do. The coaxial switch was already in position here and it was convenient to make the connections shown. An average 65' separation ($\pm 5'$) was maintained as the wires were supported by PVC pipe and tree limbs.

Performance is condensed in Table 1. Note that the MW band was sub-divided into five receive spectra. For each, segment stations were located in four compass directions within thirty degrees. By switching between the two longwires, it was possible to record the S-UNIT difference in pick-up. The final column shows the S-UNIT ratio between the long-to-short wire readings. Note in segment one that the longer wire was completely dominant in all directions. The second segment shows the performance of the short wire catching up to that of the long wire, with the exception of the west directions. Here, the west directivity of the longer wire becomes apparent.

Section three is touch and go between the two wire lengths. However, the westerly directivity of the longer wire continues to stand out. In Section four, the long wire begins to fall apart as compared to the short wire, with the exception of its due west pick-up. Section five favors the short wire. Even the com-

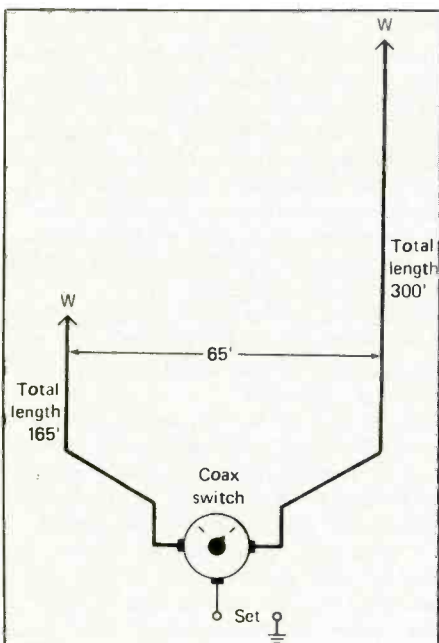

Figure 5: Separate longwires for high and low frequency ends of MW band.

antennas

H. C. Van Valzah Co.
Downers Grove, IL 312/852-0472

**Butternut Trombone®
SC-3000**

**Scanner Antenna
for the "Pros"**

High gain pulls in the weak signals that aren't there on conventional antennas. **\$57⁹⁵**

Antennas, our only business!

CABLE & CONNECTORS

| | |
|--------------------------------------|-------------|
| PL-259 Amphenol | each \$1.10 |
| RG213/U non-contaminating jacket/ft. | .35 |
| Connector installation | 3.00 |

ANTENNAS

| | | |
|---------------------|---------|---------|
| SC Avanti Base | AV801 | \$37.95 |
| SC A/S Centerload | MON38 | 24.95 |
| SC A/S Discan | MON64 | 19.95 |
| SC A/S Mobile Mag. | MONR51 | 37.95 |
| SWL Butternut | SWL2-30 | 47.95 |
| SWL B&W | ASW60 | 57.50 |
| CB Moonraker IV | AV 140 | 209.95 |
| CB PDL II | AV 122 | 139.95 |
| CB Astro Tenna | HV 150 | 114.95 |
| CB Hustler Hi-power | RM11S | 43.95 |
| CB Mobile Moonraker | AV261M | 68.95 |
| CB 8' Heliwhip | Hw 11-8 | 9.95 |

Add \$3.00 for shipping in U.S.

Send 50¢ for antenna and accessories catalog—18 pages

TO ORDER
CALL

1-800-HAM 0073



H. C. Van Valzah Co.

1140 Hickory Trail Downers Grove, IL 60155

Satisfaction Guaranteed

Rush me my copy of the Dick Smith Catalog, I enclose \$1 to cover shipping

Name

Address

City

Zip

DICK SMITH ELECTRONICS INC.
P.O. Box 2249, Redwood City CA 94063



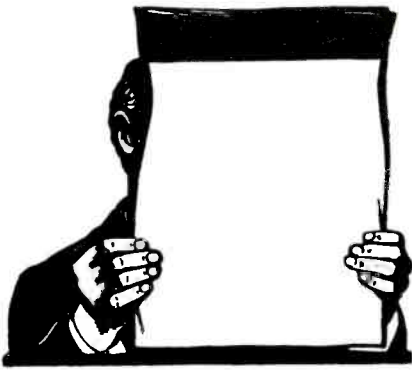

The Clandestine Confidential Newsletter

Tune In On Radio's Shadow World!

A publication devoted to clandestine stations and programs. *The Clandestine Confidential Newsletter* is designed to keep you up to date on this intriguing aspect of shortwave listening and DXing.

C-C-N is published six times a year. It contains the latest frequency and schedule information, monitoring data, background information, addresses, and features on new and old stations.

C-C-N is a continuing updater to the book *Clandestine Confidential*, published by Universal Electronics.

Subscriptions to C-C-N are \$10.00 per year in North America, \$13.00 overseas, payable in cash, check or money order, U.S. funds.

The following listings are also available:

- Clandestine Stations By Time—\$3.00
- Clandestine Stations By Frequency—\$3.00
- Clandestine Station Addresses—\$3.00
- Clandestines Of Central America—\$3.00
- Clandestines Of The Middle East—\$3.00
- Complete Set Of Newsletter Back Issues—\$10.00

To subscribe, send your remittance to:

C-C-N
Gerry L. Dexter
RR4 Box 110,
Lake Geneva, WI 53147, U.S.A.

parison westerly pick-up levels off. However, something was learned in switching between the two antennas for the 1390 kHz station. The longer antenna produced the clearer signal. There was more hash in the short antenna pick-up from other same-frequency signals. Thus, the actual minus one reading is a debatable one indeed. The long-wire decline in this segment is not at its best in this segment because its length begins to approach a half wavelength and, consequently, there is a higher impedance at the receiver end, which is not favorable for the transfer of maximum signal current to the receiver input.

The long distance performance is better evaluated at night, however, most of you understand that s-meter readings are very misleading during the nighttime hours unless the received signal is very strong. Co-channel and adjacent-channel signals, as well as noise components, contribute to the net s-meter readings. As a result, a true reading of the desired carrier level is difficult to obtain. Nevertheless, the listening quality of the received signals tell us much. The full story cannot be told in a few paragraphs. However, the general results can be summarized.

In signal reception from the westerly direction, the longer antenna almost always dominates. Even when its received signal was apparently weaker, there was improved clarity because of the lower co-channel and adjacent channel pick-up. For example,



Antenna wires dropped down mast to easy-access jumper position.

some Friday and Saturday nights the WSM signal was so strong I could switch over to wide band reception and enjoy the Grand Old Opry live on a high-fidelity speaker I can switch across the output of the receiver. Make note that WNBC New York is only 10 kHz higher in frequency than WSM. In other directions, these two antennas ran true to form. Lower frequency signals did better on the longer antenna and vice versa. However, the advantage of having two antennas was proven any number of times. Especially during the sunset hours, you could often ID two stations on the same frequency much more readily because one would dominate on one setting of the switch; the other, on the second switch position.

Two antennas can add versatility to your MW reception. Now what would happen if you directed one wire south and the other one west? Give it a try.

Thank you for your queries and comments. They are much appreciated and all have been answered to this date. I hope I can keep on schedule. Please include SASE if you wish a reply. Time limitations are such that I cannot design specific antennas. Answers must be brief for the same reason. However, many subjects will be expanded upon in this column and they do not go unnoticed in your letters. Therefore, read each column regardless of the subject heading **PC**

ACTIVE ANTENNA

•Short wave at its best!

New 3-30 MHz active antenna especially designed for SWL's. Remote probe mounts outside away from noise sources. Only 36" high but internal amplifier makes it perform like a 100' long wire.

30' of miniature coaxial cable connects the probe to its control box. This compact (only 4 x 4 x 2 in.) control features a high pass filter to eliminate overload from local broadcast stations. A post-amplifier follows the filter. The antenna operates from +12-v DC or from 115-v AC with optional adapter.



Model PA-351 \$129.95 + \$4 shipping/handling in U.S. & Canada. 115-v AC adapter \$9.95. California residents add sales tax.



Send for FREE catalog that shows our complete line of preamplifiers, loop antennas, VLF converters, audio filters and more.

PALOMAR ENGINEERS
BOX 455, ESCONDIDO, CA 92025
Phone: (619) 747-3343

PRODUCTS

REVIEW OF NEW AND INTERESTING PRODUCTS



Kit SMARTHOME Controller And Alarm

The SMARTHOME Controller and SMARTHOME Alarm, a system that controls electrical appliances and lighting and provides sophisticated security protection, has been introduced in kit form by Heath Company.

The GD-3800 SMARTHOME Control Unit controls electrical appliances and lighting by generating commands recognized by appliance, lamp, and switch modules. These commands are transmitted on the house AC lines to the modules, which are plugged into regular house outlets. The control unit can command a module to turn an appliance or lamp on or off, and can command that a light be dimmed. Three conditions can cause the control unit to send a command to a module: the unit receives a signal from a sensor in the house, the unit receives a signal from a hand-held remote, or the unit has been programmed by the homeowner to initiate the command.

Sensors placed around the house monitor items such as window/door open or closed, smoke present, and movement in a room or hall. When a sensor notes a change it transmits a signal to the control unit. The control unit then responds by sending the appropriate command to the modules in that area of the house.

The control unit may be programmed through a computer using software, which allows the operator to "draw" a graphic picture of the home. Appliances, lamps, and sensors may be "installed" in the correct locations by using icons. The Controller can then be easily programmed to activate lamps and appliances and to brighten/dim lamps at specified times. The GD-3800 can also be programmed with specific responses to signals it receives from sensors or the 12 button hand-held transmitter included with the kit. Once the Control unit is programmed, it is disconnected from the computer and plugged into an AC outlet. All of the programming information is stored in memory in the control unit.

The GD-3880 SMARTHOME Alarm Center expands the system to a complete security system. When the control unit determines, from sensor input and program-

ming, that an emergency exists (a fire or intruder), it activates the alarm center. The alarm center is capable of sounding four different alarms. The alarm activated depends on the type of emergency with a priority given in the case of a series of emergencies.

For more information, contact Heath Company, Benton Harbor, MI 49022, or circle number 102 on the reader service card.



MFJ-1701 6-Position Antenna Switch

MFJ Enterprises, Inc. is now producing the MFJ-1701, a 6-position antenna switch. This switch enables you to switch antennas with the turn of a knob. It organizes your tangle of coax cables and eliminates the need to plug and unplug those cables.

The MFJ-1701 retails at an affordable \$29.95. The equipment is mounted in a rugged yet handsome black aluminum cabinet that matches most rigs.

This 6-position antenna switch has SO-239 connectors, negligible insertion loss, low VSWR, and low crosstalk between adjacent outlets. All unused terminals are automatically grounded for static/lightning/RF protection.

The MFJ-1701 can be used for 52 to 75 ohm systems, and can be mounted with equal ease on a desk or on a wall. In addition, the MFJ-1701 handles 2000 watts SSB, 1000 CW.

This product is backed by MFJ's one year unconditional warranty. If ordered directly from MFJ, it has an additional 30-day guarantee; return it within 30 days for a full refund (minus shipping and handling) if not completely satisfied. To order, call 800-647-1800 or send \$29.95 plus \$5.00 shipping and handling to: MFJ Enterprises, Inc., P.O. Box 494, Mississippi State, MS 39762, or circle number 108 on the reader service card for more information.

Digital System Features Illuminated Keyboard

Entering the secret code to disarm your car's digital anti-theft system can be difficult at night. That's why Code-Alarm has announced its all-new, digital alarm system—the CA-1085—featuring an illuminated keyboard.

The CA-1085 is the best of the range of

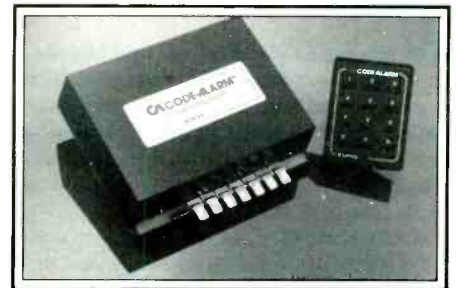

digital alarms from Code-Alarm. User friendly, the CA-1085 has keypad illumination in two colors. Numeric buttons are green, while function buttons and status indicator lights are red.

The CA-1085 is also very easy to arm. The owner can select "passive arming" to activate the system whenever the ignition is turned off. "Manual arming" is also available by cutting a loop on the back of the main unit. This allows the CA-1085 to arm only when the owner wants it to.

Opening a door lights up the keypad and it stays on at night, while driving.

Once armed, the CA-1085 detects intrusion into any part of the vehicle. This is through five different monitoring circuits, including voltage sensor.

When any of these circuits triggers the system, the alarm is activated for a one-minute cycle. After this, the CA-1085 shuts down so it can't run down the battery. The system then rearms and electronically scans all entry points for security. If a door is ajar, for example, the alarm will sound again and continue to recycle.

Other important security features have been built into the CA-1085. An exit monitor automatically delays the arming process until all doors and trunk are closed. An audio arm feature tells you that the system is fully engaged. A status indicator light warns that something has tripped the system during your absence. Adjustable entry delay allows you to custom tailor the entry time to your particular needs, and a panic button activates the alarm from the keyboard for protection while you are in the car.

Another feature of the CA-1085 is an integrated hood lock opener. It is also designed to work with all types of other alarm accessories, such as sirens, shock sensors, light flashers, pagers, etc. It is built in the U.S. and comes with a lifetime warranty.

The CA-1085 complements a full range of digital alarm systems, keyless passive alarm systems, starter kill systems, remote control anti-theft systems, plus related accessories and components from Code-Alarm.

For further information, contact Code-Alarm, 32021 Edward, Madison Heights, Michigan 48071, or circle number 116 on the reader service card.

PC

SCANNER SCENE

BY CHUCK GYSI, N2DUP

MONITORING THE 30 TO 900 MHz "ACTION" BANDS

While police departments and high-security state and federal agencies switch to scrambling and DVP for secure communications to avoid scanner listeners from hearing their messages, other two-way radio users have found a way to escape anyone who might tune in.

Mobile computer data terminals are now being used by businesses and large fleet operators in an effort not only to keep others from listening in, but also to help keep costs down and aid management in running a fleet.

In Anaheim, California, Yellow Cab Co. has installed the nation's first fully computerized taxi dispatch system. The system relies on computers for dispatching taxi cabs on calls and voice communications are virtually eliminated. Those tuning in Yellow Cab's channels in Anaheim will hear computer whines and tones on the air—hardly interesting at all for most scanner listeners.

The system in Anaheim was installed by Gandalf Technologies Inc. and is being used in 85 taxis. Mobile data terminals are installed in the cabs and the cab company's dispatch center is equipped with computer hardware and software for dispatching and fleet management. Gandalf Technologies claims those who call for a cab in Anaheim don't have to wait as long as before the system was installed because the computerized system speeds up the dispatching process, which depends on the individual skill of the dispatcher on duty.

Although radio hobbyists and scanner listeners wouldn't be bothered by the chatter on a two-way radio while riding in a cab, it is disturbing to other riders. The computer system virtually eliminates the chatter over the radio and creates a quiet ride (unless the hack's AM radio is blaring the latest hits).

When a customer calls for a ride, the dispatcher enters the name of the rider, the pickup address and a short message, if needed, into a computer terminal. The system automatically determines what area of the city the request is for and alerts the next available waiting cab via the mobile data terminal. The system used in Anaheim stores information on about 18,000 streets in a 200-square-mile area served by the cab company.

The cab driver pushes a button on the mobile terminal to acknowledge he or she is handling the call. Once the fare is completed, the driver uses the mobile terminal once again to notify the dispatch center of his or her zone and availability. The driver then will be alerted for another call when his or her turn in the line of available cabs comes around again. Because the system assigns queues for available cabs, a dispatcher cannot favor a particular driver for fares. The computerized system also prohibits other

drivers and competing cab companies from stealing fares because the computer communications over the radio are private. Because the computer communications are sent in bursts of information and take less time than voice communications, the radio system can handle a greater amount of traffic, thus conserving the available spectrum.

The system that Gandalf Technologies developed was done so in collaboration with the taxi industry over the past eight years. The firm's early versions of the dispatch system used minicomputers and the firm's MDT3601 mobile data terminal. The new system uses Digital Equipment Corp.'s new line of PDP-11 computers, modern software, and an updated version of the mobile terminal that includes new digital technology and an advanced liquid crystal display. The firm can install systems for fleets as small as 100 cabs.

The system installer claims computer dispatching creates better management through reports that are automatically generated. Management can examine how many cabs are available, request the status of a particular cab, examine taxi destinations, review future calls logged into the system, review trips already handled by drivers, audit fares, suspend a taxi from service, enter regular runs into the system, request fare status, reinstate a taxi to service, send special messages such as for a driver to call

home, review time calls, carry out a fare search, switch a taxi to voice communications or to request various reports.

The dispatcher handling calls can time calls, dispatch local calls, cancel calls, make information requests, assign a priority to cab requests, handle requests for several taxis, and request the availability of cabs on the street. Meanwhile, the cab driver can "book in" to show that he or she is available to handle calls, report no-shows, request call-outs, request voice communications with the dispatcher, report his or her destination, request information, use code reporting and even report an emergency.

The system also can automatically dispatch standard fares, calls for a particular time or in the future, regular runs and priority calls. The system also can verify street names and numbers. The system typically includes call-taker terminals, the dispatch computer system, the communications subsystem, maintenance test equipment, and the mobile data terminals. Gandalf Technologies claims each communications subsystem channel can service more than 400 taxis.

The use of digital technology means cab companies can dispatch more taxis per channel than voice communications and results in an improvement in the overall productivity of an entire fleet, the firm claims. The system also is a management tool in that



This is the passenger's view of a taxi equipped with Gandalf Technologies' computerized dispatch system. The cab driver communicates with the cab company's dispatch center by pressing various buttons on the mobile display terminal. The driver also receives calls via the terminal. (Photo courtesy of Gandalf Technologies, Inc.)

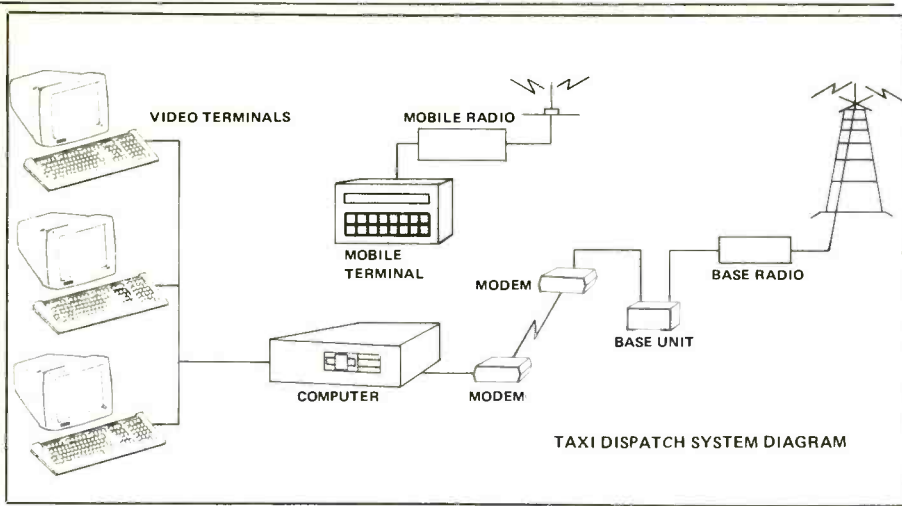

This block diagram explains how the computerized taxi dispatch system works. Telephone operators receive calls and punch in the information on the video terminals at the office and the information is sorted out and transmitted via the computer and two-way radio system. The taxi cabs receive and transmit calls via the mobile data terminal. (Diagram courtesy of Gandalf Technologies, Inc.)

| | |
|-----------------------|----------------------|
| 2499 MERIVALE RD | 1 st BOOK |
| A-401 MR SMITH | 2 nd 127 |
| CALL AT SIDE ENTRANCE | 3 BOOK |
| | 4 127 |

The cab driver's mobile data terminal receives calls as illustrated in the block diagram. The terminal receives two lines of the message at a time.

it can print out reports to indicate the number of calls the taxi firm is receiving for cabs, taxi usage, and fare distribution.

"Of course it's always pleasing to have the first dispatching system of this type in the country, but more importantly we will be able to provide our customers with a much speeded-up service," said Diane Slagle, vice president of Yellow Cab Co. of Anaheim. "Also, our company is going to benefit from the fleet management information that the system will give us."

Tune In Nashville

From the All Ohio Scanner Club comes a listing of active frequencies for the Nashville-Davidson County Metro area of Tennessee:

- 155.070 Metro Police Channel 1—western area
- 155.130 Metro Police Channel 2—countywide info/records
- 155.310 Metro Police Channel 3—eastern area
- 155.640 Metro Police Channel 4—traffic
- 155.580 Metro Police Channel 5—southern area
- 154.755 Metro Police Channel 6—car to car
- 460.600 Metro Fire Channel 1
- 460.575 Metro Fire Channel 2
- 462.950 Ambulance dispatch
- 155.340 Ambulance to hospitals
- 155.205 Medcom
- 453.700 Metro Transit Authority
- 156.240 Metro Highway Department

- 464.925 Opryland security
- 464.800 Opryland Hotel

New 900 MHz Band

Amateur radio operators with technician class or higher licenses now can operate in a new 902-928 MHz band. Operation is on a secondary basis. Several groups across the nation are planning on operating repeaters and other types of experimental radio communications on this new band. If you have one of the newer scanners that can cover this band, it might be worthwhile checking it out. The bandplan for the 902 MHz band is listed in the *American Radio Relay League's Repeater Directory*.

Input Sought

We're interested in hearing from you here at POP'COMM. Your letters, frequency lists, and photographs are always welcome and are a big help in preparing this column each month. We want to know what you want to read about in Scanner Scene. We're in the process of preparing a story on traffic helicopters and planes used in major cities across the United States by radio stations, TV stations, and traffic reporting services. If you know of any currently used frequencies, please drop us a line and let us know. We'll share the list in an upcoming column here at Scanner Scene. Write to: Chuck Gysi, N2DUP, Scanner Scene, Popular Communications, 76 North Broadway, Hicksville, NY 11801-2909. **PC**

ICOM



ICOM R71A
100KHz - 30MHz
CALL FOR PRICE



ICOM R7000
25MHz - 1.3GHz Plus
All Mode
Top of the Line Scanner
CALL FOR PRICE



THE HAM STATION
220 N. Fulton Ave.
Evansville, IN 47710

Orders: 1-800-523-7731
Indiana: (812) 422-0231
Service Dept.: (812) 422-0252

AMEX MC VISA, & COD



Your passport to ham radio adventure is TUNE-IN THE WORLD WITH HAM RADIO. Book tells what you need to know in order to pass your Novice exam. Cassette teaches the code quickly and easily.

Enclosed is my check or money order for \$10.00 or charge my

() VISA () Mastercard () Am. Express

Signature _____

Acct. No. _____

Good from _____ Expires _____

Name _____

Address _____

City _____ State _____ Zip _____

THE AMERICAN RADIO RELAY LEAGUE
225 MAIN ST.
NEWINGTON, CT 06111

CIRCLE 142 ON READER SERVICE CARD

BROADCAST TOPIX

BY MARK MANUCY, W3GMG

DX, NEWS AND VIEWS OF AM AND FM BROADCASTING

The band is not becoming less crowded. Listening the other night on 1160 kHz, I heard the new station near Nashville on 1200 kHz. There are several stations besides the station in Leesburg, Virginia and WOAI, which are new to 1200. Of course, long time listeners of 1160 expect to hear WJJD or KSL. These days of clear channels are being diminished rather quickly. I say "these days" with some reservation, since by the time you read this there could well be another dozen stations on the air. If you're like me and always looking for a new station, this is good news. But if you're like me and love to listen to that station halfway across the country, it might appear the days for long distance U.S. DX may be numbered. The FCC is issuing many new licenses on both U.S. clears and the Canadian/Mexican clears as well. It is a mixed emotional feeling to many.

How many frequencies are there that you have not been able to log even one station? On the AM band candidates would be (depending on what part of the country you live) 640, 650, 690, 700, 730, 750, 870, 1010, 1210, and maybe a few others. In the daytime there is a great chance the list would be much larger, again depending on your location. Long hours of listening for that station to finally fade-in for a few brief moments is the only way to cut the number of vacant channels down to zero. In the daytime it will take quiet locations and good antennas. I have one FM channel that is still a blank for me (91.7). The AM's have been filled for years. Actually, there is another game to play with the AM band, and that will become much harder in the months ahead. That game is to log all the stations on a frequency! Up until a few years ago, I had several of these marked off. But as previously mentioned, new stations are being added all the time. If you live in the center of the U.S., there might still be a chance to accomplish this feat if some sunrise and sunset monitoring is done.

AM Stereo

My last report on AM stereo may have been a bit on the pessimistic side, however I am happy to report this month on two positive factors. First, Kahn has added four new stations to his list and second, Sony has released their multi-mode AM stereo auto radio. It is model XR-A33 and preliminary reports I heard about this receiver were very good. It is as good as FM stereo (fidelity-wise in the car), and the AM stereo has much better range than the FM stereo, depending of course on the power of the station. If you are in the market for a multi-mode AM stereo auto radio, then this is the first one I've heard

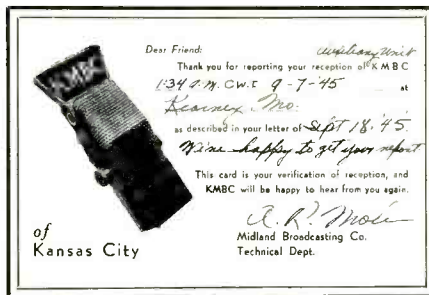

KMBC used a picture of RCA 44 DX mike on the back of a penny postcard.

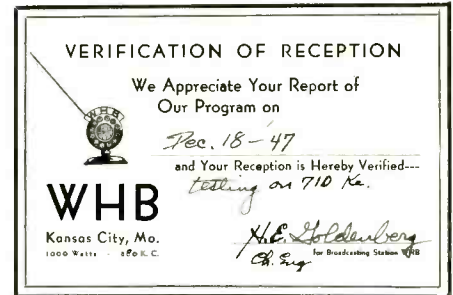

WHB changed frequency about 1948.

of in a year. If you can't find one around, then you might write to Kahn Communications at 425 Merrick Avenue in Westbury, NY 11590, and maybe they can help you out. The price class of this receiver is about \$250. The new Kahn stations are KBBJ in Tulsa, OK, KORD in Tri-Cities, WA, KOZE in Lewiston, ID, WNAQ in Waterbury, CT, and

WQIK in Jacksonville, FL. C-Quam has a new installation at WANN in Annapolis, MD.

On the subject of AM stereo, John Lyles sent me a letter telling me of his interest in AM stereo. He has gone to the extent of rebuilding old AM "hi-fi" receivers to accommodate the Motorola MC 13020P decoder shown in the January '84 *Radio Electronics*

Station Updates

| Call | Location | Freq | Pwr | Ant |
|-----------|-----------------------|------|-------|-------|
| AM | | | | |
| KKAR | Hesperia, CA | 540 | 1.5/0 | NDA |
| KOTZ | Kotzebue, AK | 720 | 10/10 | NDA |
| WKBC | N. Wilkesboro, NC | 800 | 1/0 | NDA |
| WABA | Aguadilla, PR | 850 | 5/1 | NDA |
| KBBI | Homer, AK | 890 | 10/10 | NDA |
| WRNA | China Grove, NC | 1140 | 1/.25 | DA-D |
| KPEL | Lafayette, LA | 1420 | 1/1 | DA-N |
| KONP | Port Angeles, WA | 1450 | 1/1 | NDA |
| WBUL | Fort Knox, KY | 1470 | 2.5/0 | DA-D |
| WSDS | Ypsilanti, MI | 1480 | 5/3.8 | DA-2 |
| WGFW | Morovis, PR | 1580 | 2.5/1 | DA-2 |
| FM | | | | |
| WHCF | Bangor, ME | 88.5 | 100 | 1604' |
| WJDZ | Levittown, PR | 88.9 | .01 | 50' |
| KTEC | Klamath Falls, OR | 89.5 | .1 | 184' |
| WHLA | La Crosse, WI | 90.3 | 100 | 1010' |
| WFAE | Charlotte, NC | 90.7 | 100 | 390' |
| WBUQ | Bloomsburg, PA | 91.1 | .6 | N/C |
| KUAF | Fayetteville, AR | 91.3 | 100 | 296' |
| WKCL | Ladson, SC | 91.5 | 9 | 175' |
| WCKR | Hornell, NY | 92.1 | 1.26 | 510' |
| WOFM | Moyock, NC | 92.1 | 1.7 | 420' |
| WJRQ | Williston, FL | 92.1 | 1.7 | N/C |
| WZEW | Fairhope, AL | 92.1 | 3 | 289' |
| KROK | De Ridder, LA | 92.1 | 1.2 | 505' |
| KKFR | Glendale, AZ | 92.3 | 100 | 994' |
| WCKW | La Place, LA | 92.3 | 100 | 1954' |
| KAER | Sacramento, CA | 92.5 | 115 | 449' |
| WJSM-FM | Martinsburg, PA | 92.7 | .331 | 983" |
| KTWA | Ottumwa, IA | 92.7 | 3 | 300' |
| KSPZ | Colorado, Springs, CO | 92.9 | 52.7 | 2130' |
| KQID-FM | Alexandria, LA | 93.1 | 100 | 1540' |
| WKRY | Key West, FL | 93.5 | 3 | 74' |
| WQID | Biloxi, MS | 93.7 | 100 | 1183' |
| WHBC-FM | Canton, OH | 94.1 | 43.8 | 516' |

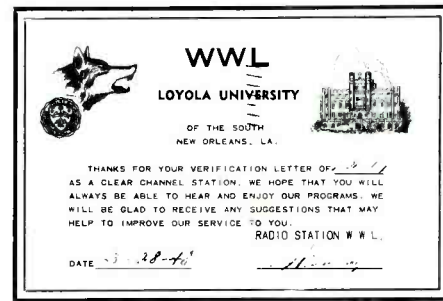
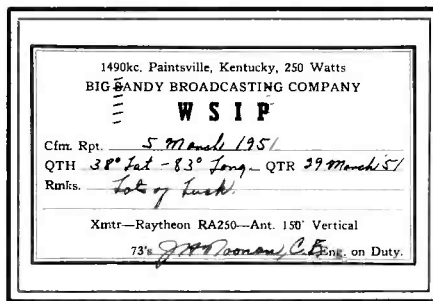
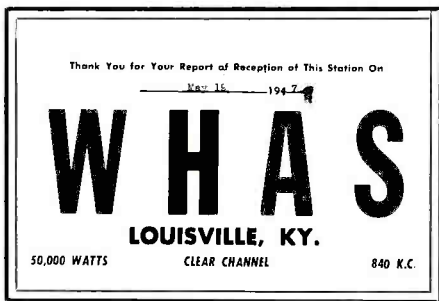

circuit for an AM stereo decoder. He took an old WWII E. H. Scott SLR-12 receiver to feed this stereo decoder. John said, "It is really something when the output is piped into my living room stereo system. AM can really sound good when the station cleans up its act, too."

I continue to get questions about the Sony

SRF-A100 stereo AM radio. John Lyles sent, in his letter, some response checks he made with the Sony using a Broadcast Electronics AX-10 Stereo exciter. His results were similar to the ones I saw at the NAB lab in Washington. The NAB was using the Delta Electronics exciter. Basically, this radio has a response of ± 3 dB from about 80 to

7500 Hz in the "wide" position with the tone at full clockwise rotation. The response is down 6 dB at just over 10 kiloHertz. (See previous columns for more info on the SRF-A100.) It is my understanding that Sony has discontinued this model and I have seen nothing to replace it as yet by any manufacturer. If you can still find one, it is an exceptional small AM radio. I have logged KFI (640) Los Angeles in Baltimore with this radio without any external antennas or boosters. I heard KFI in stereo, too! I certainly hope someone will put out a good portable radio with the stereo decoders for AM as well as FM.

Due to the earthquake in Mexico, the agreement between the U.S. and Mexico has been delayed a few months. The Mexican "FCC" offices were badly damaged and, although I understand the FCC has agreed to help with the Mexican paperwork, it will still take some extra time before the U.S. stations on Mexican Clears can operate at night.

Mail Call

A regular contributor, Bud Stacey, sent an interesting newspaper clipping from the *Mobile Register* of November 12, 1985. I had been told several weeks ago by Steve Zeigler of WIOD/WAIA in Miami, FL that the long time giant (50 kw) WGBS on 710 had changed format and call letters. WGBS used to be owned by the George B. Storer group, hence GBS, one of the front runners in programming and prestige in the broadcast community. WGBS was bought in 1979 by the Jefferson Pilot Group, who also own WBT in Charlotte, NC. Jefferson Pilot sold WGBS last year. The new format is Spanish language programming and, according to the Mobile paper, Castro has been jamming 710 kHz because WAQI (WGBS) in Miami has been operating with its full power at night. WAQI is licensed for 50 kw using a separate directional pattern day from night. Anyway, WKRK in Mobile operates with 500 watts at night on 710 as well and the interference makes things rough on them. There are water-paths in-

| | | | | |
|---------|--------------------|-------|------|-------|
| KESS | Fort Worth, TX | 94.1 | 98 | 696' |
| WLVI | Elmira, NY | 94.3 | 1.28 | 497' |
| WKSL | Greencastle, PA | 94.3 | 2.49 | 360' |
| KRXL | Kirksville, MO | 94.5 | 42 | 990' |
| KFMX-FM | Lubbock, TX | 94.5 | 100 | 817' |
| WTYX | Jackson, MS | 94.7 | 100 | 117' |
| WZXM-FM | Gaylord, MI | 95.3 | 3 | 300' |
| WWMJ | Ellsworth, ME | 95.7 | 1.5 | 1029' |
| KEFM | Omaha, NE | 96.1 | 100 | 1456' |
| KSJT-FM | San Angelo, TX | 97.5 | 34 | 606' |
| WTHM | Goulds, FL | 98.3 | 1.55 | N/C |
| KUPL-FM | Portland, OR | 98.5 | 100 | 1104' |
| WAWZ | Zarephath, NJ | 99.1 | 23.4 | 723' |
| KZYP | Pine Bluff, AR | 99.3 | 3 | 157' |
| WSTR-FM | Sturgis, MI | 99.3 | 2.16 | 390' |
| WXFM-FM | Mount Zion, IL | 99.3 | 1.13 | 497' |
| KDLB-FM | Henryetta, OK | 99.5 | 100 | 984' |
| WHEB-FM | Portsmouth, NH | 100.3 | 50 | 154' |
| WJER-FM | Dover, OH | 101.7 | 3 | 328' |
| WDRM-FM | Decatur, AL | 102.1 | 100 | 728' |
| WBBY-FM | Westerville, OH | 103.9 | 2.57 | 300' |
| WIFI | Kane, PA | 103.9 | 3 | 226' |
| KHOM | Houma, LA | 104.1 | 100 | 1954' |
| WFYV | Atlantic Beach, FL | 104.5 | 100 | 984' |
| WLSR | Lima, OH | 104.9 | 3 | 287' |
| WVDL-FM | Scranton, PA | 104.9 | .27 | 1093' |
| WZLI | Toccoa, GA | 106.1 | 100 | 1240' |
| KGRA | Kermit, TX | 106.3 | N/C | 274' |
| WVOJ | Avon Park, FL | 106.3 | 1.55 | 370' |
| WVIP-FM | Mount Kisco, NY | 106.3 | .8 | 597' |
| WJQY | Ft. Lauderdale, FL | 106.7 | 100 | 984' |
| KAZY | Denver, CO | 106.7 | 100 | 987' |
| KMAJ | Topeka, KS | 107.7 | 100 | 1214' |
| KAEZ | Oklahoma City, OK | 107.7 | 98.5 | 990' |

KEY: D = Daytime N = Nighttime DA = Directional Antenna DA1 = Same Pattern Day & Night DA2 = Different Pattern/Power Day/Night NDA = Omni Antenna Day and/or Night * = Special Operation or Critical Hours N/C = No Change

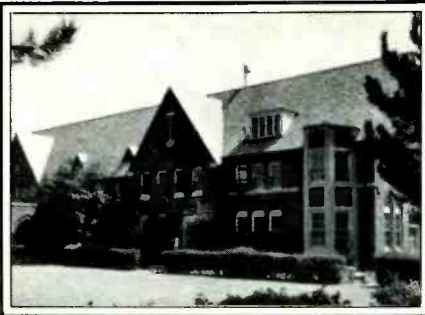

KFJL AM/FM St. Louis, Missouri is owned by the Lutheran Church—Missouri Synod. This postcard is from 1965. (All QSLs and postcards on these pages are from the collection of Bob Grubb)



This is a stereo decal from station WANN in Annapolis, Maryland.

involved in all directions here, and whether or not WAQI is operating outside of their license, they always have a strong signal into the Florida Keys at night and across the water to Cuba. No doubt any jamming by Castro would not be from a directional antenna and, therefore, the signal would carry very well over the water to Mobile. Thanks for the info, Bud.

L. Farnsworth writes with some of the Washington, DC SCA operations. One of the programs currently on the SCA frequencies is the PRN, or Physicians Radio Network. Farnsworth heard four stations with this from his home—102.1, 104.3, 105.7, and 106.7. Data was heard on 104.1 and 103.5. Background music still predominates, however, heard on 88.5, 92.3, 92.5, 93.3, 98.9, 101.1, and 102.5. Radio reading services are on 90.9 and 96.1. One different program heard was Chinese programming on Saturday at 8 p.m. on 95.5. To hear these stations, he has a Yaesu FRG-9600 with a Capri decoder. The Yaesu has a multiplex output jack for such uses.

With so many video cassette recorders being sold today, it seems that TV DXing may get a shot in the arm—especially with all the new low power TV stations and additional

translators being put on the air. Ben Goozner writes telling of several translators he has picked up. There are many translators on the higher channels, Ben. The channels from 69 to 83 are almost exclusively used for translators. Many of the VCR's will have better tuners than the TV set currently owned by many, although the newer sets have excellent tuners. This will make TV DXing easy since you can tape while you are searching and play the tape back as many times as you need to ID the station!

From the Philippines comes a letter from Greg Harris. He's in the Navy and one of his hobbies is BCB DXing. Some of his recent catches he thought might be interesting or available to the stateside DXers are: Hong Kong on 566, Radio Beijing on 1342, and ARTN in Taiwan on 1550.

Mike Chinakos sent me a clipping from the *Columbian* of Vancouver, WA with a story of people living on Cougar Mountain near Seattle. It seems they are troubled, not with Cougars, but with RFI. Let me tell you about RFI; it will create havoc with VCR's, TV's, stereo systems, telephones, burglar alarms, and sometimes dental work and other strange things. Most of this comes from residing too close to a high power transmitter,

be it broadcast or otherwise. Ask any ham or BC station engineer. Well, it seems the people on the mountain are having more and more guests in the form of huge broadcast towers! They've had enough and don't want anymore. The picture in the article shows a man holding a 40 watt fluorescent tube near a guy wire of one of the towers. The lamp, quite naturally is giving off a bright glow. This is one of the things that upset the people living on the mountain—radiation from all these transmitters. I don't want to berate their concern, but it doesn't take much power to ignite the gas in a fluorescent tube. Any of you who have a long wire antenna a couple of hundred feet long can make the gas in a fluorescent tube flash easily. Place the tube where the antenna comes into your house and wrap two or three turns of the antenna wire around the tube and connect the end to ground. Tell me what happens during the next thunderstorm! Many hams with low power transmitters use the 4 foot tubes to show power near their antennas. Thanks for the article, Mike. It was fun reading.

John Mayson finds the Tampa Bay area in Florida good for DXing. Why? With a low tie antenna he was able to get Channel 15 in Mobile and gets lots of Latin American DX with his Panasonic RF-3100. Can't argue with that, John!

Another good DXer is the GE Superadio II according to Michael McCarty. He says the AM and FM sections of this radio are very good. He quotes quite a bit of DX to prove it. The Model II, according to Mike, has an extra IC that the Model I did not have.

Farmer's Almanac

What does a DXer want with the *Farmer's Almanac*? Well let me tell you how one can use the *Almanac* to improve your DXing. What affects DX? How about weather? How about the sun? How about the sunrise and sunset times, eclipses, meteor showers, and the length of twilight? Most are aware that some of these items affect DXing, but actually they all can affect DXing on the AM, FM, or TV bands. I don't have time to go into every item this month, but let's take a couple. Sunrise and sunset are the best times for DXing. *The Old Farmer's Almanac* lists the sunrise/sunset times every day for Boston, with time correction tables for the rest of the country. Meteor showers can give some excellent FM and TV DXing. Page 38 lists the principal meteor showers through December, showing the date of maximum rates and the maximum rates to be expected as well as the direction! More on these next month. For \$1.95, this is a cheap DX aid! Most newsstand and convenience stores will probably have copies.

The Commodore computer programs that I had available have been updated and the new group will provide customized logs to suit your fancy. Write for details. Also write for details on loop antenna plans, both ferrite and box types with preamps. Your mail is interesting and valuable. Keep it up! My address is P.O. Box 5624, Baltimore, MD 21210. See you next month.

SUBSCRIBER SERVICE

CHANGE OF ADDRESS

Planning to move? Please let us know six weeks in advance so you won't miss a single issue of POPULAR COMMUNICATIONS. Attach old label and print new address in space provided. Also include your mailing label whenever you write concerning your subscription to insure prompt service on your inquiry.

POPULAR COMMUNICATIONS
76 N. Broadway,
Hicksville, NY 11801

ATTACH LABEL HERE

NEW ADDRESS HERE

PLEASE PRINT

NAME _____

ADDRESS _____

CITY _____ STATE _____

DATE _____ ZIP _____

INSIDE THE WORLD OF TVRO EARTH STATIONS

Satellite Comm First

An Air Force Communications Command unit from Travis AFB, California, became the first Military Airlift Command-attached unit to use a new type of satellite communications last September. Members of the 1901st Information Systems Group employed a method created and developed at Scott Air Force Base in Illinois to manually track and communicate via a moving communications satellite from Palmerola AB, Honduras.

With a home computer, MSgt. Pierre Ferendzo of the contingency and exercise management directorate had devised a method for using moving communications satellites without tracking equipment.

"I don't know what stimulated me at first," said the sergeant. "It was about a year ago that I came across the Lincoln satellites, and I just pursued."

Before exercise Cabanas 85, communicators in the field were confined to locking their portable antennas onto geosynchronous satellites—those satellites that revolve about the earth precisely above the equator at the rate equal to the earth's rotation. Without the means to track moving objects, the portable antennas had to rely on geosynchronous communications satellites, the only ones that appear to hang motionless in the sky.

Competition is keen for the time on geosynchronous satellites. When one malfunctions, users can be left without access. However, Sergeant Ferendzo found an alternative—the Lincoln experimental satellites.

"The Lincoln satellites—there are two—are not geosynchronous," said Sergeant Ferendzo, exercise manager in Airlift Information Systems Division's contingency and exercise management directorate. "They are unique, as they move plus or minus 25 degrees (above the earth's surface). They're owned by the Air Force, but they're managed by Lincoln Labs of the Massachusetts Institute of Technology."

These research satellites appear to trace figure eights in the sky, so users must move their antennas to keep communications beams on target. However, Sergeant Ferendzo guessed the portable antenna beam width would permit some off-center use. It seemed this margin for error would allow for non-continuous tracking, leaving an antenna stationary for periods of time as the chosen satellite drifts in the beam.

Working on a Commodore 64 home computer, the noncommissioned officer wrote and refined two programs—one to lo-



From his desk in the Military Airlift Command headquarters building at Scott AFB, Illinois, MSgt. Pierre Ferendzo plans for deploying communications units to remote locations around the world. (U.S. Air Force photo by Capt. Milford A. Guttridge)

cate a Lincoln experimental satellite and one to manually track it.

"Once I was able to get to it, the programs took about a week to write," said Sergeant Ferendzo. He added that several revisions were required to work out the bugs. Sergeant Ferendzo then demonstrated his method in December 1984 with a test of the system.

Satellite terminals were established for the test at Scott AFB and Travis AFB. The Scott AFB terminal was able to maintain acceptable communications, with no antenna realignment, throughout the eight hour demonstration. Although the noise level increased as the orbital motion of the satellite moved it as much as 18 degrees from the antenna, acceptable communications were maintained at Scott AFB. Physically located farther from the satellite, the Travis AFB team had to realign their antenna twice, but they too maintained acceptable communications without special tracking equipment.

This successful test brought approval for use of the method in the field. The first opportunity was exercise Cabanas 85 in Honduras, where an AFCC team was supporting the military airlift mission. From Palmer-

ola AB and other spots in that Central American country, seven members of the 1901st ISG set up communications links with a Lincoln satellite to successfully track and use a moving satellite manually.

Lincoln Labs experimental satellites were launched as part of a research and development program to improve the survivability of communications satellites against electromagnetic and physical hazards. Although they are at the proper altitude for geosynchronous orbit, they are not geostationary. They trace a figure eight pattern 25 degrees north and south of the equator and 2.8 degrees east and west daily. The north-south swing provides extended satellite coverage of the polar regions, as well as enhancing satellite communication capability within the North and South American continents. Both satellites stay within the longitudes of the contiguous United States.

"Sergeant Ferendzo has been a real asset to us," said AISD Director of Contingency and Exercise Management Maj. Michael D. Devereaux. "The use of LES is one of a number of firsts. He's always looking for imaginative solutions to MAC's command and control problems."

PC

The RTTY logbook really bulges this month with your contributions. Let's get to the loggings right away and find out why some of you haven't done your school homework and others haven't seen your wives for quite some time.

2812: EBA, Madrid Naval Radio, Spain, w/test tape RYRY, SGSG & foxes, 850/100R at 2310. This was first time in 2 years I saw this station using its normal callsign. Usually see this one under the guise of AME (now no longer used) or 72JKL (Editor's logging).

2975: Foxes & "DE HI BOB NSWC/D" followed by numerals 1 to 0, repeating tape at 0211, 425/45N. Who/what/where? (Tom Kneitel, NY).

4171: EGWM, VITORIA, a Spanish tanker, working GKE, Portishead Radio, England, at 2159, ARQ (Editor's logging).

4172: WR3225, M/V MIDDLETOWN, an American freighter, working WLO, Mobile AL at 2215, ARQ (Editor's logging).

4173.5: SIJD, IVAN GORTON, a Swedish freighter, w/AMVER to VCS, Canadian CG, Halifax, ARQ at 2330 (Editor's logging).

4175.5: PGQN, PACIFIC LADY, a Dutch freighter transporting fruit Cuna-Bulgaria w/Telex at 0240 via PCH (Holland), ARQ (Editor's logging).

4177: SMDH, BETHORE, a coal-carrying vessel w/Telexes to WCC, Chatham R., at 2338, ARQ (Editor's logging).

4356.5: WCC, Chatham Radio, MA, w/traffic to WMFZ, M/V 1ST LT. ALEX BONNYMAN, apparently a ship of U.S. fleet, possibly with USN. Its sister ships are the HAUUE, BAUGH, ANDERSON, & FISHER. None of these are shown in my records as being with U.S. fleet although messages sent seem to indicate they are. Monitored in ARQ at 2007. Anybody have additional information on this? (Editor's logging).

5104: Un-ID station at 2345 in ARQ. Sending long strings of letter F, M, the number 8 plus a few other letters (Kneitel, NY).

5395: ELRB w/RYRY, 425/66R at 0100. What station is this (Tom Brailey, Kentwood, MI). Tom's a newcomer both to RTTY & this column-- a recent victim of the bite of the RTTY bug! To answer your question, Tom, ELRB is one of those wierd callsigns you'll see every now and then. It's used by Monrovia Aero, Liberia -- Ed.

5685: 6VU, ASENCA, Dakar, Senegal, w/RYRY, 850/66R at 0330 (William Hoban, Wauwatosa, WI). Welcome to the column, Bill! Your logging was also monitored by Tom Brailey of MI-- Editor..

5761: HOTEL 33, --35, & --37, all U.S. Army units, working one another from 0432 to about 2000 sending "play-by-play report" of mock battle vs. simulated enemy army. Was 85/60R (that's right, 85 Hz shift, 45 baud!). Guess which army won? (Editor's logging).

6257.5: UKCJ, MOSSOVET, a Soviet liquified gas carrier w/teleggrams to Odessa Radio, USSR, 170/66N at 0133 (Editor's logging).

6844.6: MKD, RAF station at Akrotiri, Cyprus, w/foxes & RYRY test tape, 170/66R at 2200. Station FDY, French Air Force, Orleans, France, also noted this frequency (Fred Hetherington, Ormond Beach, FL).

6736: ETD3, Addis Ababa, Ethiopia, RYRY in 850/50R at 0335 (Kneitel, NY).

6848: SOG284, Warsaw, Poland, ending its English PAP news BC at 2150, 425/66R (Hetherington, FL).

6861.3: EBA, Madrid Naval Radio, Spain, w/RYRY & foxes at 0930 while calling FUG, LaRegine Naval R. in France, 850/100R (Hetherington, FL).

6975: 6VU, ASECNA, Dakar, Senegal, w/RYRY, 425/66N at 0410 (Hoban, WI).

6992.6: KAWN, Carswell AFB, Texas, w/weather data 85/100R (no time given). Was embedded in FDM transmissions running from 6990 to 6993 kHz (Hetherington, FL). Carswell is an SAC base near Fort Worth-- Ed.

7428.5: TELAM, Buenos Aires, Argentina, at 2350 w/news in Spanish, 850/66R (Editor's logging).

7474: TJK, ASECNA, Douala, Cameroon, w/RYRY, 425/66N at 2127. ASECNA is an African aviation agency (Editor's logging).

7593: 6VY41, Dakar Meteo, Senegal, w/RYRY & CQ test tape, 425/66N at 2320 (Editor's logging).

7604: HGE36, Budapest Meteo, Hungary, w/RYRY tape, 425/66R at 2311 (Editor's logging).

7690: TUH, Abidjan, Ivory Coast, testing at 2315, RYRY QJH1, was 425/50N (Kneitel, NY).

7946.2: DJH51, Gregel Meteo, W. Germany, w/test tape, CQ's, RYRY at 2045, followed by coded weather data, 425/66R (Editor's logging).

7950: Y2V6, Berlin, E. Germany, ADN news in Spanish at 2322, 425/50N (Kneitel, NY).

7954.5: DyN, Buenos Aires, Argentina, w/news in Spanish, 850/100R, at 2327 (Kneitel, NY). Also logged w/news in Spanish at 0015 (Editor's logging).

7981: AP, London, England, w/news in English at 2110, 850/66N (Editor's logging).

8123: TNL, Brazzaville Aero, Congo, RYRY, 425/66R at 0235 (Hoban, WI).

8156.7: MKD, RAF station, Akrotiri, Cyprus, w/test tape of RYI's & foxes, 170/66R at 0000 (Editor's logging).

8301: UZLW, LEONIDE SOBINOV, Soviet passenger ship w/Telexes to Odessa Radio USSR, 170/66N at 0200 (Hoban, WI).

8345.5: Panamanian freighter ATLANTICA w/Telexes to IAR, Rome R., Italy, in ARQ at 2008 (Editor's logging).

9086: Y7A38, Berlin, E. Germany, diplo traffic in German at 1332, 425/100N. Also noted at 1314 another day in 525/50N! (Kneitel, NY).

9217: 5UA, ASECNA, Niamey, Niger, w/RYRY at 2200, 425/66N (Hoban, WI).

9226: TJK, ASECNA, Douala, Cameroon, w/RYRY, 425/66N at 2245 (Hoban, WI).

9788: FTJ8, Paris, France, diplo news in French, 425/50N at 1330 (Kneitel, NY).

9994.1: CSY, Santa Maria, Azores, w/RYRY at 2338 in 850/50N (Kneitel, NY).

10100: CLN281, Havana, Cuba, w/RYRY, foxes, "ZHC ZRO?" at 1333, 425/50N. Same transmission picked up on 10114, 10128, 10142 kHz (Kneitel, NY).

10220: RCC Havana testing to ITT Worldcom NY w/RYRY at 1340, 425/50R (Kneitel, NY).

10235: STK, Khartoum, Sudan, w/RYRY at 2346, 425/50R (Kneitel, NY).

10440: Y3A5, Berlin, E. Germany, calling Damascus ("Damas") at 1343, 425/50N (Kneitel, NY).

10543: Y2V54, Berlin, E. Germany, English news at 1331, 425/50N (Kneitel, NY).

10590: Lengthy transmission of RYRY's broken only occasionally by "DIME MIRA MANO TODAVIA QSA ?/? OKOK." 425/45N at 0009. Whatzit? (Kneitel, NY).

10670: GYU, British Royal Navy facility at Gibraltar, w/RYI's & foxes tape, 850/66R at 1635, followed by messages from GUF, and un-ID British Naval unit, to FUG on another frequency. Wonder if FUG here is French Navy station at LaRegine (France) that was on another freq., or a tactical ID for a British Naval unit. All messages were in English & of a routine nature (Editor's logging).

10805: Un-ID station in Argentina, 850/50N at 0010 w/Spanish "NA" news BC (Kneitel, NY).

10967.5: FDY, Orleans Aero, France, w/RYRY & "VOYEZ LE BRICK GEANT QUI J'EXAMINE DU GRAND WHARF," 425/66R at 2100 (Hoban, WI). Translation is "See the giant brick which I examine near the big wharf." The Americans & British like to test w/foxes; the French prefer "bricks"-- Ed.

11413: GXQ, Royal Air Force, London, England w/RYI's & foxes tape at 1243, 170/66N (Editor's logging).

11431: GXQ, Royal Air Force, London, England w/RYI's & foxes tape, 170/66R at 1948. Compare this logging w/that on 11413 kHz. The RAF conducts its RTTY tests in N or R polarity w/o any preference for either one (Editor's logging).

12137.1: Mexican government stations "DF" (Mexico City), "GN" (Ensenada), and "LIC" (La Isla Cedros), among others w/traffic in Spanish, 170/75N (57 baud) at 2245 (Hetherington, FL).

12175: WBR70, Miami, FL, at 1325, 850/75N w/hurricane reports (Kneitel, NY).

12212.5: YZ07, Belgrade, Yugoslavia, w/TANJUG news in English at 1619, 425/66R (Editor's logging).

12504.5: 4PKM, ship PACIFIC UNIVERSAL working NMN, USCG at Portsmouth, VA, ARQ at 2008 (Editor's logging).

12322: SKM, Colombian Navy, Bogota, Colombia, w/RYRY & SGSG tape, 1937, 425/75R (Kneitel, NY).

12510: WFZC, DOCK EXPRESS TEXAS, a Dutch heavy-lift cargo vessel, w/message to WLO, ARQ at 1954. Here's an example so often found w/sailing vessels; a callsign mismatched to the vessel's ownership. In this case, the vessel is owned by a Dutch firm but is flying a U.S. flag. In the majority of cases, you'll find it is the American or Greek owned vessels that are registered under so-called "flags of convenience" in nations such as Liberia and Panama (Editor's logging).

12522.5: UTOM, VALENTIN SHEVCHUK, w/teleggrams in Russian, 170/66N at 1950, to Kaliningrad, USSR (Hoban, WI). Bill, this is a Soviet stern-trawler factory ship. The "KLD" on the 1st line of the messages denotes that the message is going to Kaliningrad-- Ed.

13372: NBA, US Navy, Balboa, Panama, logged at 1948 w/test tapes to ZPK, Asuncion Naval Radio, Paraguay, followed by naval traffic in Spanish. Was 850/100R (Daryll Symington, Holland, OH). Welcome aboard, Daryl!-- Ed.

13418.2: STK, Khartoum Aero, Sudan, w/test tape reading "RYS RYS RYS" at 2015, 425/66N (Editor's logging).

13437: "RPFN," a Portuguese Navy unit with RYRY & foxes tape, 850/66R at 1505 (Symington, OH).

13520: FSB72, INTERPOL, Paris, France, w/message describing stolen religious icons. In ARQ at 1650 (Editor's logging).

13523.5: Y1071, Baghdad, Iraq, English INA news BC at 1324, 425/66R (Editor's logging).

13540: Text mentions "2 SAECKE DIPLOMATIC MAIL." Was 425/66R at 2000 (Brailey, MI). From the complete message you furnished, it appears that this was from E. German embassy in Washington DC-- Ed.

13580: Ministry of Foreign Affairs, Bern, Switzerland, w/5-letter grouped messages to the Swiss Ambassador, Washington DC at 1548, ARQ (Editor's logging).

13597.5: OL12, Prague, Czechoslovakia, CTK news in English at 1341, 425/66N (Editor's logging).

13636: SUA50, Cairo, Egypt, MENA news in English & French at 1345, 500/50R (Kneitel, NY).

13840: KRH51, U.S. embassy, London, England, w/RYRY, at 1000, 850/100R (Frankie Gittens, Secretary of Caribbean SWL Club, St. Michael, Barbados, West Indies). Another new contributor to these pages. Now we have RTTY monitors living in Europe and the Caribbean. Welcome aboard, Frankie!-- Ed.

13998: FTN99, DIPLO, Paris, France, w/French news BC, 425/66N at 2147 (Darrell Lingenfield III, Chambersburg, PA).

14461.3: "Y7L36" sending a message in German to Berlin at 2200, 325/66N (Hetherington, FL). This callsign is used by the E. German embassy in Havana, Cuba-- Ed.

14462: Un-ID station, possibly a Cuban embassy w/5-letter groups coded traffic at 2245, 425/66R (Symington, OH). This might be the same station in the 14461.3 kHz logging, but since the RTTY shift is wider here, your logging might be CLP1, MFA, Havana, Cuba, which uses 425 & 500 kHz RTTY shifts-- Ed.

14500 kHz: XJJ250, location unknown, at 1430 w/following test tape: XJJ250 . 14500WT GJK&WJE FTERB&BDJ GE OFBV GFG DFHYDFD" plus 3 lines of RYRY. In repeats of this tape, the letter combinations remained the same. Encrypted messages followed at 1505. Was 425/66R. My guess is that this station is transmitting from Warsaw, Poland. On another day on this frequency, there was found SUC60, Cairo Aero, Egypt w/message at 1613 regarding the use of runway 33L/15R. This one was 850/66N (Editor's logging).

14573: JANA, Sliema, Malta, at 1608 w/test tape consisting of "PT)" and YRYR. "PT)" translates into English as JANA. Stations transmitting

in Arabic send test tapes of RYRY as YRYR's! (Editor's logging)

14631: ISX46, Rome, Italy, w/ANSA news in English at 1541, 425/66N (Editor's logging).

14724: TNL, ASECNA, Brazzaville, Congo, w/RYYR tape at 2000, 425/66R (Editor's logging).

14760: Rabat, Morocco, w/MAP news in French, 425/66R at 1600 (Hoban, WI).

14776.2: SUC66, Cairo Meteo, Egypt, w/coded weather, 425/66R at 1552; wasn't // with 14738 kHz where different coded weather was being sent by same station. The latter station, however, was pausing between takes (Editor's logging).

14794.5: Paris, France, at 1300 w/AFP news in Arabic, 350/66N (Editor's logging).

14882.5: Rome, Italy, w/LINA news in English, 425/66N at 1257 (Editor's logging).

14912: DFZG callsign & RYRY test tape, 425/100R at 1431. Then came 3-digit grouped traffic encryption (Dallas Williams, Sedgwick, CO). This callsign used by a Yugoslav embassy, but I haven't been able to figure out where. DFZG also monitored on 18042.5 for the past 2 years. Any reader know where it is?-- Ed.

16107.5: Ministry of Foreign Affairs, Bern, Switzerland w/messages in German or containing 5L coded groups, being sent to Swiss Ambassador in Washington, DC, ARQ at 1350. Long-time RTTY monitors will recall this frequency as having been used by DIPL0-Paris for news BC's. It appears that DIPLO abandoned this frequency in late '84 or early '85 and now the Swiss government uses it (Editor's logging).

16117: Dakar, Senegal, w/PANA news from various African press services, in French, 425/66R at 1421 (Editor's logging).

16201: SOQ221, Warsaw, Poland, PAP, w/RYYR at 1440 in both N & R polarities (Williams, CO).

16230: 4UZ, United Nations, Geneva, Switzerland, w/RYYR & traffic in English/French at 1420, 425/100R (Williams, CO).

16397.4: FTQ39, DIPLO, Paris, France, w/review of British press in French, 425/66N at 1433 (Editor's logging). Same station at 2147 on 16398 kHzw/news in French (Lingenfield III, PA).

16681: HZRA, ALKSIMA ALARABIA, a Saudi ore/oil carrier, working GKA at 1705, ARQ (Editor's logging).

17453: CLN565, PTT Havana, Cuba, w/RYYR, 425/66R at 2240 (Hoban, WI).

17500: RFLIG, French Navy, Cayenne, traffic in French to RFLIA/SERVESSENOGS at 2050, <850/50R (Kneitel, NY).

17536: MKD, Royal Air Force, Akrotiri, Cyprus, w/foxes & RYI's, 170/66N at 1625 (Hoban, WI).

17540: NBA, U.S. Navy, Balboa, Panama, relaying messages at 2010 from "Escola de guerra naval" (Naval War College) in Brazil to similar units throughout S. America. Was 850/100R (Hoban, WI). Brazil acted as host nation during recent Inter-American war games exercises (IAWG-85) and similar traffic has been also noted on other frequencies by your columnist. Gittens of Barbados reports logging similar traffic on 16194.7 kHz-- Ed.

18220.9: CNM76/X9, Rabat, Morocco, MAP w/RYYR & sked of news BC's at 1522, 425/66R (Williams, CO).

18860: ZAT, Tirana, Albania, w/ATA news at 1715, 850/66R (Gittens, Barbados). According to Perry Ferrell's Confidential Frequency List, this BC is a frequency logged harmonic of 9430 kHz-- Ed.

18955.9: A VOA station, reported to be in Botswana, working VOA facility at Montrovia, Liberia, 85/100N at 1150. Daily skeds (Hetherington, FL). Fred, I think the transmitter might be at Gaborone, Botswana. My Encyclopaedia Britannica atlas doesn't list the town you mentioned-- Ed.

19068.4: Rabat, Morocco, w/MAP transmission sked & news in French at 1527, 425/66R (Williams, CO).

19080: British unit "MUN," location undetermined, w/5L-group coded "drill" message followed by RYRY & foxes, 600/66R, 1310-1500 (Hetherington, FL). Most likely sent from British Army base somewhere in Europe-- Ed.

19313: 4UNF, U.N. Economic Commission for Africa, Addis Ababa, Ethiopia, w/messages in French at 1412, 425/100N (Lingenfield III, PA).

19865: YZJ4, TANJUG, Belgrade, Yugoslavia, w/news in Serbo-Croat, 425-66N at 1412 (Lingenfield III, PA).

20140: CNN91, Rabat, Morocco, w/MAP English news BC to Latin America, 425/66N at 1534 (Lingenfield III, PA, & Gittens, Barbados).

22205.5: NAE, USNS DE STEIGUER, w/position report & request for news BC to NMO, USCG Honolulu, in ARQ at 2130. This is an oceanographic research ship operated by the USN's Military

Sealift Command. Unarmed, it is manned by a civilian crew & scientists. It was launched 20 years ago (this month). NMO was transmitting on 22574.5 kHz, sending NAE a radio news summary of AP-UPI sports news prepared by the AFRTS station at Los Angeles (Editor's loggings).

In The Mail

Better late than never department... The meteorological station at Paris, France recently informed me that it had ceased its RTTY transmissions as of January 1, 1985. All weather data is now transmitted by the French P. T. T. for use by the maritime industry. Radio transmissions of such data will be a rarity, Meteorologie Nationale said. No indication was given as to how the data is now being sent. My guess is that it's by satellite.

E. R. Flynn of San Rafael, California,

seems intrigued by all the frequencies he's monitored with test tapes of continuous "THE VERY QUICK BROWN FOX JUMPED OVER THE LAZY DOGS BACK," being sent at 850/100R. He wants to know what station sends these test tapes because callsigns never accompany the wordage.

Well, I can tell you that it is the U.S. Navy you're monitoring. But which COMMSTA's send on what frequencies will have to go unanswered. The Navy Department won't answer any inquiries, especially after all the hullabaloo last year that resulted from the espionage ring that passed Navy secrets to the Soviet Union. Since then, the Navy really has gone on the defensive (no pun intended) and refuses to say anything about its communications network. **PC**

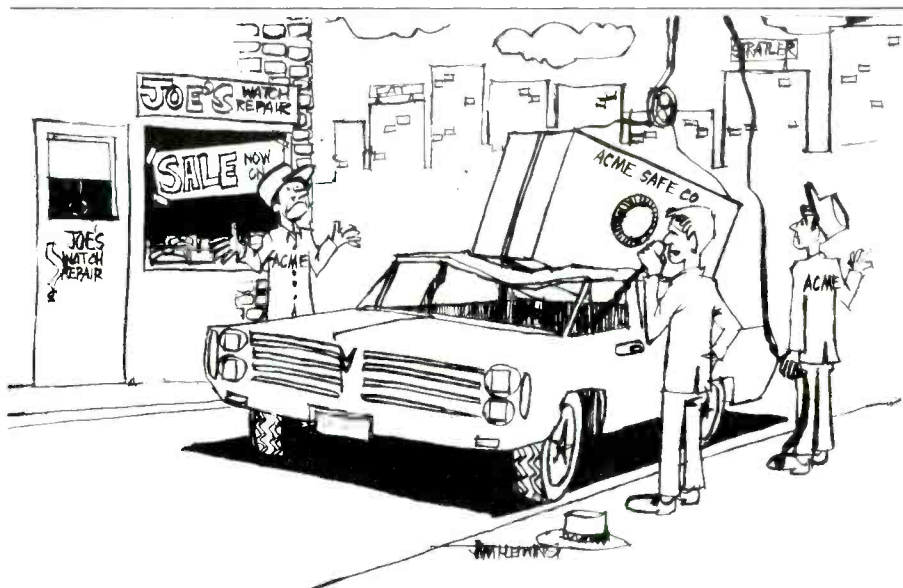

"YOU SAY MY SIGNAL DROPPED A BIT THERE?"

BUGGED???

Find hidden radio transmitters (bugs) in your home, office or car. The TD-17 is designed to locate the most common type of electronic bug - the miniaturized radio transmitter - which can be planted by anyone, almost anywhere.

The TD-17 warns of the presence of nearby RF transmitters, within the frequency range of 1 MHz to 1,000 MHz, when the RF Alert LED turns on. The flashing Range LED and audio tone give an indication of the distance to the bug. The Sensitivity control, used in conjunction with the two LEDs, helps you quickly zero in on hidden bugs.

The hand-held TD-17 weighs less than 7 oz. and is housed in a high-impact plastic case. Furnished complete with battery, antenna, instruction manual and one year Limited Warranty. Save \$100 to \$200 and order at our factory direct price of only \$98. VISA and MASTER-CARD accepted. Satisfaction guaranteed or your money back.

FREE literature.

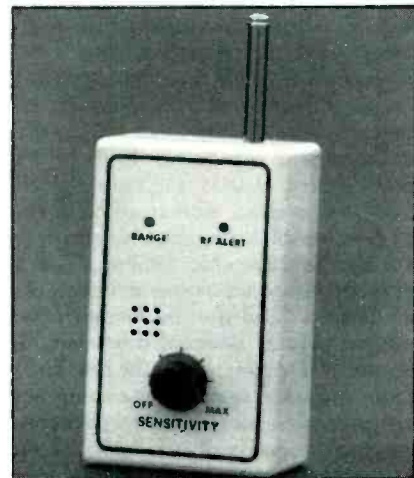

CAPRI ELECTRONICS
Route 1G
Canon, GA 30520
(404) 376-3712

RADAR REFLECTIONS

RADAR DETECTORS AND THEIR USE

BY JANICE LEE

New Jersey Tries To Supersede Federal Law

New Jersey's state legislature has one bill pending (A3666 introduced by Assemblyman Martin) to outlaw radar detectors and another one that is anticipated to be introduced by Assemblyman David Schwartz.

In the past, similar bills have been proposed in legislatures in approximately 30 states. These bills have been defeated on the basis of constitutional issues and the sheer impracticality of such a law. Leading this fight against the radar detector bans is an organization called RADAR, Radio Association Defending Airwave Rights, Inc. Since its inception in 1984, RADAR has been instrumental in squelching at least 12 such unconstitutional attempts.

RADAR's defense is based on the fact that any state legislation proposing the prohibition of radar detectors has already been preempted by congressional mandate; the fact that police radar's capricious fallibility has been established; and the fact that a radar detector ban would violate citizens' right of free speech. The Communications Act of 1934, as amended in 1982, places the sole responsibility for the legislation of radio receivers with the United States Congress. Therefore, a state legislature cannot regulate radar detectors, which are simply radio receivers tuned to the frequencies used by police radar. Similar to an auto's AM/FM radio, radar detectors receive airwaves. They do not interfere with police radar's operation in any way.

The pre-emption issue is but one of the constitutional issues which run counter to the radar detector ban now being considered in your state's legislature. Others include the constitutional guarantee of free speech and the potential for interference with interstate commerce. The constitutional issues are supported by the impracticality of such a law which plagues it from its drafting through its application. In those three areas where prohibitions of radar detectors have been in effect, numerous court cases have been instituted against the laws or regulations. Selective enforcement of just the apparent dashboard mounted models of radar detectors and not the hidden remote units constitutes unequal treatment, and therefore protection, under the law. The assumptions made regarding the radar detector owner as it relates to these statutes constitutes the abrogation of due process as well. These and other issues have been the source of protracted litigation everywhere where radar detector bans have been enacted.

Despite these facts, some law enforcement agencies and state legislators still clamor for state legislation to make radar detectors illegal. They imply that all owners of



radar detectors habitually drive over the posted speed limits, thereby posing a safety hazard. Adherents of anti-radar detection legislation overlook that (1) radar detectors are the public's response to the misuses of police radar and that (2) the use of radar detectors has grown in direct proportion to the public's awareness of radar's fallibility.

The five-year study of police radar commissioned by the National Highway Traffic Safety Administration (NHTSA) has proven the inadequacies of radar equipment beyond any doubt. A follow-up testing of equipment by the International Association of Chiefs of Police (IACP) in 1984 reaffirmed radar's fallibility. In Volume I of the IACP's tests, they admitted that 25% of the radar units tested operated outside the allocated frequency bands. One area that compounds the equipment problems (that was also admitted by the NHTSA) is the inadequate, misleading, and sometimes non-existent operator training programs. One startling fact on this subject is that New Jersey is the most populated police radar state in the United States . . . making it easier for the average motorist to receive an unwarranted speeding ticket.

Even if a radar detector ban did not violate the Communications Act and the Constitution, enforcement of such a ban presents a real public relations nightmare. Officers enforcing this ban are compelled to search for and seize the detector as evidence. In a free country, most motorists find allowing police officers to rummage around looking for detectors presumed to be there simply intoler-

able. They will not accept the idea that the police (or the legislature) can regulate what they can or cannot listen to. Citizens believe that the First Amendment protects their right to hear as well as their right to speak. This right includes hearing a radar detector.

Radar Detectors Are Legal In Kentucky!

Relax motorists—your radar detectors are once again legal in Kentucky thanks to RADAR, The Radio Association Defending Airwave Rights, Inc. The legality of radar detectors came into question during the summer of 1985 when two Kentucky district judges interpreted differently the state's statute banning police radios in vehicles.

In May, 1985 District Judge Julia K. Tackett fined Lexington resident Darold Lee Bactell, Jr., \$100 for the possession of a police radio. She also ordered that Bactell's radar detector be confiscated. The following month, District Judge Michael B. Roney dismissed charges that Phillip B. Handyside from Toledo, Ohio, possessed a police radio. He also ordered that Handyside's confiscated radar detector be returned. These decisions were based on the same statute.

In July, Bactell's case was retried before Judge Tackett. The charge against Bactell was dismissed and his radar detector returned. The judge stated that a radar detector is not within the scope of statute KRS 432.570. This statute bans "any mobile radio set or apparatus capable of either receiving or transmitting radio or other messages . . . which may in any way intercept or interfere with the transmission of radio messages by police."

The opinion issued by Judge Tackett listed three reasons for reversing the decision. First, to avoid being unconstitutionally vague, the statute must be interpreted from the point of view of a person or ordinary intelligence. The average person does not realize that a radar detector receives radio waves or that, technically, it is a radio receiver.

Secondly, the Kentucky General Assembly enacted this statute in 1942, long before radar detectors were available to motorists. The purpose of the statute was to protect the confidentiality of two-way police communications. Speeding was not the crime the statute was passed to prevent. This is illustrated by the fact that Kentucky's maximum fine for speeding is \$100, while the penalty for using a radar detector is a \$50 to \$500 fine or imprisonment for up to twelve months, or both!

Third, radar detectors neither receive nor interfere with police radio messages or police radar. The frequencies used for police communications are different than those used by police radar.

Supporting this decision is the testimony of a state police official before a legislative subcommittee in June, 1985. He said that the state police began confiscating radar detectors in the 1970's. They stopped this practice when convictions were overturned on appeal. In 1979 a state attorney general's opinion declared the law too vague to be applied to radar detectors. The chief justice of the Kentucky Supreme Court also issued an opinion that the law was too vague. Such opinions do not carry the force of the law; they are strictly advisory. It appears that Kentucky police will continue writing citations for police scanners, but not for radar detectors.

Texas Speed Trap Has A Reputation

Burly John Kirby threatened, "I'll hunt you up if you don't tell the truth," snapping the pump mechanism on an empty shotgun to emphasize his point. Click, click.

Kirby, an alderman who doubles as police

commissioner in Combes, Texas (a Harlingen suburb of 1,441 people), was already irritated when a reporter arrived at his truck service business on a hot afternoon.

The questions were about reports Kirby's town has become a new "Valley of the Bears" and is operating a speed trap on Expressway 77 in deep south Texas.

"You damn people don't tell the truth," he snarled, continuing to work on the apparently defective weapon. "... If they want to call it a speed trap, I don't give a damn. All they have to do is slow down."

The tough-talking Kirby said if somebody lied about him, he would give them a beating, pay his fine, then repeat the process over and over. He said his town was enforcing the law and the news media, during a slow time for news, was digging around for stories.

Parking Valet Charged In Fuzzbuster® Thefts

Authorities arrested a 19-year-old valet

attendant in connection with the thefts of Fuzzbusters® from cars being parked at casino hotels in Atlantic City, New Jersey.

Police said thefts of such devices—which can cost from \$200 to \$400—are "big business" at many valet parking lots, especially at casinos.

Capt. James Dooley of the police department's Casino Hotel Investigations Unit said radar detectors are stolen frequently because they cost so much and can easily be sold for half the price—which is still a fairly large sum of money.

He added that owners of radar detectors should keep their serial numbers so that, if the devices are stolen and recovered, they can be identified.

"Any type of appliance, be it a Citizens Band radio or a stereo, should have the serial numbers recorded," Dooley said. "A phone call can trace it. A serial number helps a lot in recovery." **PC**

Janice Lee is the Editor of Monday, A.M., the newsletter of Electrolert, Inc.

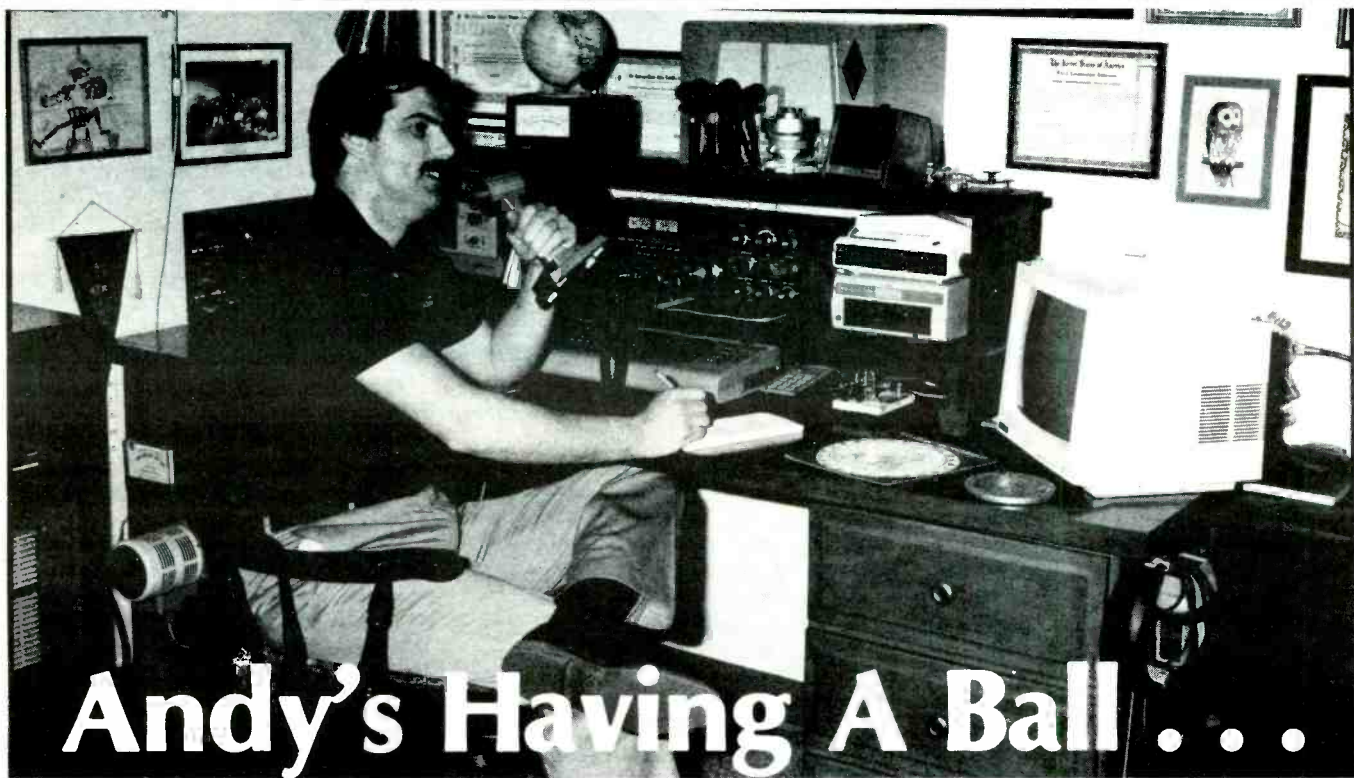

Andy's Having A Ball . . .

Andy is a Ham Radio operator and he's having the time of his life talking to new and old friends in this country and around the world.

You can do it too! Join Andy as he communicates with the world. Enjoy the many unique and exclusive amateur bands . . . the millions of frequencies that Hams are allowed to use. Choose the frequency and time of day that are just right to talk to anywhere you wish. Only Amateur Radio operators get this kind of freedom of choice. And if it's friends you're looking to meet and talk

with, Amateur Radio is the hobby for you. The world is waiting for you.

If you'd like to be part of the fun . . . if you'd like to feel the excitement . . . we can help you. We've got all the information you'll need to get your Ham license. Let us help you join more than a million other Hams around the world and here at home. Who are we? We're the American Radio Relay League, a non-profit representative organization of Amateur Radio operators.

For information on becoming a Ham operator circle number 110 on the reader service card or write to:

AMERICAN RADIO RELAY LEAGUE

Dept CQ, 225 Main Street
Newington, Conn. 06111.

This space donated by this publication in cooperation with the American Radio Relay League.

NEW AND EXCITING TELEPHONE TECHNOLOGY

Text And Graphics Over The Phone

Although most of the traffic that goes over phone lines is regular speech, there is an ever increasing amount of traffic that consists of text, data, and graphics. Text down phone lines is far from new. Stock prices have been sent down phone lines on a stock ticker almost as long as there have been telephones. Thomas Edison, besides inventing many parts of the modern phone, also held patents on stock tickers. The first "phone lines" just carried Morse code, then voice and text. Today, there are many ways to send text and some of them are very fast, sending words much faster than they can be read.

The old stock ticker seen in the movies living under a bell jar was a simple device. It consisted of a wheel covered in raised type which spun around and, when it came to the right letter, struck a piece of paper tape. It had two wheels, one for letters and one for figures and punctuation. The ticker was a receive-only device and worked very slowly. It did, at least, supply New York with tons of waste paper that could be thrown out of windows for "ticker tape parades."

The first send and receive machine that printed on pages, not lines, was the Telex. This machine is still in extensive use today. The news bureaus use versions of these machines to send news reports to newspapers and TV stations. Telex is landline based RTTY, sometimes called TTY. It is also known as teletype. It is identical to classic RTTY in most respects. It uses Baudot or Murray code signalling. The character set on a Telex is limited to 32 characters, with no shift available between upper and lower case characters.

The Telex system has over 1.5 million subscribers worldwide and is a direct dial network, just like the telephone. If you dial someone's telex number, you will be connected directly to their machine and can, if you wish, carry out written two-way conversation—just like RTTY. Most Telex traffic is written before transmission in order to speed up the flow of traffic.

The Telex baud rate is 50 baud. The standard method of signalling down a Telex line has been by reversing the polarity of the line for mark and space. These days, most Telex systems use audio tones (Audio Frequency Shift Keying), the same system that is used on RTTY.

Telex equipment today has gone away from the old electro-mechanical machines, such as the Teletype and Creed. Most Telex terminals today are small computers with memory to store incoming messages, CRTs to edit text, and dot matrix printers. This is the same move that has been made with RTTY.



A doctor examining an x-ray sent to him over the phone line from a distant hospital via the "IMTRAN" system.

In most countries of the world, Telex is run by the telephone company, who is often also the postal service. Here in the U.S., Telex service is run by Western Union, ITT, and RCA. Although Telex is old, it is the only worldwide text landline system. It is extensively used for international trade and travel. Most large hotels and businesses have a Telex machine.

British Telecom, the British telephone company, which is one of the most innovative companies in the world when it comes to text and graphics via phone line, has just committed themselves to spending over \$100,000,000 over the next few years to upgrade their Telex network. Western Union, on the other hand, is doing their best to discourage use of Telex. When a potential customer calls Western Union requesting service, they are usually sold something called "Easy Link" instead. This is not Telex; it is electronic mail. If you want Telex, demand it from Western Union or go to another carrier who is willing to supply it.

Another point-to-point text service is called TWX (pronounced *twix*), sometimes called Telex II. It works in much the same way as Telex but uses ASCII, which gives a full keyboard with upper and lower case. It is also twice as fast as Telex; its speed is 110

baud. Unfortunately, TWX service is limited to the U.S.

The most up to date system for sending text is called Teletext. This is a point-to-point system using regular phone lines and sending fully word processed text at 2400 baud. At this speed, a full page of text takes less than seven seconds to send. Teletext machines can store text and send it out when the phone rates are cheaper. At this speed, and coupled with the fact that voice lines are cheaper than Telex lines, Teletext is the wave of the future.

Many companies offer forms of EMAIL. This is simply a large mainframe computer somewhere that subscribers dial into and leave messages for each other. If you think you have a message, you have to call in to the system to find out. With Telex, TWX, or Teletext, the message arrives at your machine immediately and live two-way communication is possible. There are several EMAIL systems, such as Compuserve. The Source, Easy Link, GTE Telemail. If you are a subscriber to one, you cannot leave a message to a subscriber on another. Some systems have a means of sending messages to other systems overseas, but not all. EMAIL is, at the moment, tricky to use and not very versatile. Most EMAIL systems have a Telex

gateway so you can send a message to a Telex subscriber, although the Telex subscriber may find it difficult or impossible to answer. To use EMAIL requires a modem and terminal or personal computer.

Then there is FAX (facsimile transmission), which is not a new idea either. Newspaper photographs have been sent via telephone lines since the 1930's. During the early fifties, there was much excitement about FAX being the wave of the future, with a FAX machine in every home. The biggest users of FAX are the people in the far east. This is because their written language does not fit well onto a keyboard and most of their communications are handwritten. FAX is a very useful way to send pictures, maps, and diagrams. If you are writing with the Latin, Greek, Hebrew, or Cyrillic alphabets, it is faster to use a keyboard system such as Telex.

Some FAX systems are very slow, depending on bandwidth and picture quality. A black and white photograph takes about twenty minutes to transmit. Some of the modern ones that can only transmit line detail with no shades of gray can transmit a page in about 30 seconds.

Waiting to happen in a big way is a system called Teletex or Videotex, not to be confused with Teletext. This is a system for sending data down the phone line to a subscriber consisting of text and graphics viewed on a regular TV screen. This is ideal

for airline timetables, weather reports, etc. The French and English have large installations of this type of system. The French have even put telephone directories on their Videotex system.

The latest graphics system to come along is a system developed by British Telecom called IMTRAN (IMage TRANSfer). It is designed to send X-rays and body scans along the phone lines. To send a body scan picture direct from the CAT scanner to a doctor's office anywhere in the world takes 32 seconds. With the high cost of medical equipment, this new system should be very popu-

lar. There are some trial units being tested in the U.S. at the moment. The picture is received on a high resolution TV monitor and can be stored on a VCR like any TV picture. As the picture is sent over voice lines, it can be stored in its raw form on a cassette recorder.

There are many other ways to send text and graphics via the phone lines that we do not have the space to delve into further. One of these is, of course, Slow Scan TV. In the next few years, the sort of signals going down phone lines will change more and more, although the old standards like FAX and Telex will be with us for some years **PC**

SUBSCRIBER SERVICE
CHANGE OF ADDRESS

Planning to move? Please let us know six weeks in advance so you won't miss a single issue of **POPULAR COMMUNICATIONS**

Attach old label and print new address in space provided. Also include your mailing label whenever you write concerning your subscription to insure prompt service on your inquiry

POPULAR COMMUNICATIONS
76 N. Broadway,
Hicksville, NY 11801

ATTACH LABEL HERE

NEW ADDRESS HERE

PLEASE PRINT

NAME _____

ADDRESS _____

CITY _____ STATE _____

DATE _____ ZIP _____

HUGE 70 PAGE

SHORTWAVE CATALOG

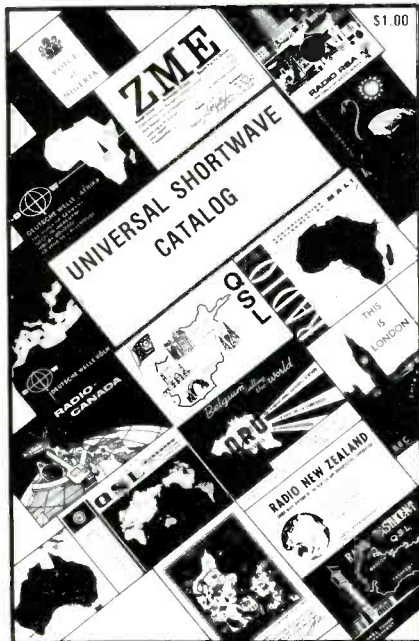

SHORTWAVE CATALOG

Send \$1.00 (or 3 IRCs) fully RE FUNDABLE.

UNIVERSAL SHORTWAVE RADIO

1280 Aida Drive
Reynoldsburg, Ohio 43068
Phone: 614-866-4267

Call us **FREE 1-800-626-6343**
or write for **FREE Flyer.**

COPPER ELECTRONICS

4200 PRODUCE ROAD - LOUISVILLE, KENTUCKY 40218

| | |
|--|---|
| <p>WIRELESS VIDEO</p>  <p>WAWASEE Introduces the American made Model WB700 wireless home video transmission system</p> <p>Retail 119.95 59.95</p> | <p>WESTPORT WCB40 40 CHANNEL CB TRANSCEIVER</p>  <p>DYNAMIC "Push-to-Talk" LED Digital Microphone Channel Display</p> <p>Retail 89.95 29.95</p> |
| <p>AV-261 Permanent Mount 1/2" hole mount Retail 89.95 26.95</p> <p>AV-261M Magnet Mount Retail 89.95 29.95</p> <p>AV-261T No-Hole Trunk Mount Retail 89.95 26.95</p> | <p>BEARCAT 20/20</p>  <p>Retail 299.95 199.95 Aircraft, marine and public service-all within pushbutton reach.</p> <p>uniden Bearcat Retail \$309.95 269.95</p> <p>Limited Quantities</p> |

LOWEST PRICES IN THE COUNTRY!

We have a national factory warranty service on many brands, and we service All CB, Amateur, and Commercial Equipment.

PIRATES DEN

BY DARREN LENO, WDOEWJ

FOCUS ON FREE RADIO BROADCASTING

For the past few months, we have been following the results of an FCC raid against Russel Rierson, the man behind the mic at pirate stations KBBR, KRZY, and KQRP.

In a telephone interview, Russel told me that a rumour circulating that he had been arrested was false. But the rumour about his equipment being confiscated was true. Most of it has since been returned to him, but the Viking II transmitter that sent his voice into shortwave receivers throughout North America is gone for good.

Not long ago, Russel and his attorney appeared before a federal magistrate to enter a plea of guilty to two of three charges of operating an unlicensed radio transmitter.

Now Russel must pay \$120 a month (plus interest) until his \$1200 fine is met.

If he hadn't already paid a \$1000 fine last year for operating KRZY, the amount wouldn't have been so painful. As it was, Russel had to drop his college electronics classes to hire his attorney.

Russel isn't too concerned about the one year of unsupervised probation he received. He can't see himself ever turning on a transmitter again, at least not to operate a pirate station. In fact, he says, he has lost all interest in pirate broadcasting, especially the "Free Radio" movement, to establish a minimally regulated citizen's broadcasting band. He seems hurt that the people who were sending reception reports to his stations, the ones that said they supported "Free Radio," all but vanished when he needed their support most.

Across The Dial

Deviant Radio Heavy metal music and comedy are on the program at this radio station. Charles Poltz in Manitoba reported a good signal in Winnipeg on 6242 kHz during a Sunday broadcast at 0615 GMT.

KLUN Charles Poltz tuned in this new pirate on 7445 kHz at 0730 GMT. The program consisted of pop music and talk about the National Football League, particularly the Minnesota Vikings.

KVOS Paul Spurlock of Alabama tuned in the "Voice of the South" on 7423 kHz from 2325 until 2345 GMT. Announcer Wavey Davey was playing music by Phil Collins.

Radio Placelessness Also calling itself the Voice of Placelessness, Charles Poltz has noted this pirate several times on 6325 kHz around 0430 GMT. Listeners were told to send reception reports to magazines and club bulletins.

WGGR This station prefers country music, according to Charles Poltz. The male and female announcers known as Larry and Barnbi were playing musical selections that included Johnny Cash and Lou Reed, among



Elmer Cronkright #13
This is to verify your reception report of Radio Nova.
Date: June 23, 1985
Time: 2135-0247 GMT.
Frequency: 7410 KHz in the 51 metre band.
You were tuned to our:
● North America Service
○ European Service: relay station-
○ International Service
The staff of Radio Nova thanks you for your reception report and hope that you will tune in again.
Fight for Free Radio!
Monty Python

others. A good signal was heard on 7460 kHz at 0805 GMT.

WGUP "The Gup" was playing heavy metal rock music on 7437 kHz at 0610 GMT. Charles Poltz in Manitoba wonders where to send reception reports, as no address was announced.

WHOT

"Dear Darren,

"I picked up an FM pirate station in the New York City area on Friday morning, Sept. 27, 1985, while hurricane Gloria was threatening the east coast. WHOT was on 91.5 MHz, playing musical oldies and professional sounding jingles, and taking phone calls on the air. This is also the frequency that legal, non-commercial station WNYE-FM uses. WHOT sometimes takes their frequency after they have signed off for the evening.

"The announcer claimed to be broadcasting somewhere in Brooklyn. Oddly enough, another New York pirate I heard several years ago, WFAT, also claimed to be broadcasting from Brooklyn. They used to operate on 1620 kHz. The announcer at WHOT, and that pirate's format sounds very much like the old WFAT.

"Martin Wishnewitz, NY"

QSL'ing Pirates

Most pirates love to hear from their listeners, at least as much as listeners like to hear from pirates. But some listeners seem to hear from pirates more often and more quickly than others do. Here are a few suggestions to help you increase your pirate QSL card collection.

Pirates will usually announce an address on the air. These addresses are usually operated by a third party who forwards mail to the pirate on your behalf. Listeners are often asked to submit their reception reports in a



John Kottarski, New York, searches the waves for pirates at the helm of this monitoring station—KNY2PO.

particular way to help the mail drop operator speed things along. A common request is for three First Class stamps to be included. One stamp is used to mail your report from the mail drop to the pirate, the second to mail your QSL from the pirate back to the mail drop (so the postmark won't give the pirate's location away), and the last is used to mail the QSL card from the mail drop back to you. If you wish to send a cassette tape of the broadcast to the station, you should include 5 First Class stamps.

Failure to follow instructions may mean that your reception report will not be forwarded, or even more likely, that it will not be answered.

Your reception report to the pirate should include the time, date, frequency, signal quality, and details of the program you heard—all the information you would send to a legal broadcaster.

Pirates have traditionally not responded well to photocopied multi-lingual fill-in-the-blanks reception reports, for the same reason you don't respond well to junk mailings. Letters like these are boring and have a tendency to be put off while the pirate answers other, more interesting letters. Take the time to add the "personal touch." It really works! But if it doesn't work within 60 days, send a follow up report.

In Conclusion

For more than a decade and a half, thousands of Londoners regularly tuned in Radio Jackie. Then, on February 4, 1985, British authorities raided the station and closed it for good.

To commemorate this popular station, World Music Radio, another pirate, sends word that the "Radio Jackie LP" is available. The record has more than 40 minutes of jingles and highlights from Radio Jackie broadcasts from 1969 to 1985. Order from



wymn
women's radio
7427 khz
this will
confirm your
reception
on
May 12, 1985
0100 to 0235...

thanks for
your report
support
womens
media!



#17
MEDIEVAL
RADIO
TO ALMER Kronkright
OF Michigan

Date 2-19-85
Time 0017-0445
Freq 7427
Power 250Watts

Elmer Kronkright has mastered the techniques for QSLing pirates. The WYMN QSL is one of the first to be received from this interesting pirate.

World Music Radio, Dept. PC, PO Box 4078, 1009 AB Amsterdam, The Netherlands. Write and ask them for an order form.

The Association of Clandestine radio Enthusiasts is a good source for up-to-date information on pirate, clandestine, and spy-number broadcasts. For membership information, send a long SASE to A*C*E, PO Box 452, Moorhead, MN 56560.

Readers equipped with a home computer and telephone modem can call the A*C*E Computer Message System at 913-677-1288, 300/1200 baud. Kirk Baxter, the system operator, says well over 1,000 messages on pirate and clandestine broadcasting have been posted.

Another good source of pirate radio infor-

mation is the Ontario DX Association. Their slick monthly bulletin contains Mike Csorbay's "Alternate Airwaves" column, a good forum for discussion of illegal broadcasting. For a sample of DX Ontario, send \$1.50 to ODXA, c/o Mr. Cedric Marshall, Dept. PC, PO Box 232, Postal Station Z, Toronto, Ontario, Canada M5N 2Z4.

My most sincere thanks to the contributors of this month's column. I'd like to hear from you by next month. Your loggings, reproductions of QSL cards, comments, stories, opinions, hints, and anything else you'd like to send along should be addressed to The Pirates Den, c/o Popular Communications, 76 N. Broadway, Hicksville, NY 11801. Thanks for tuning in. **PC**

SUPER LONG PLAY TAPE RECORDERS

10 Hour Model - \$95.00*
14 Hour Model - \$159.00*

Modified Panasonic Slimline, high quality, AC-DC Recorders provide 5 or 7 continuous hours of quality recording & playback on each side of cassette for a total of 10 or 14 hours depending on model. Built-in features include: • Voice level control. • Digital counter etc. TDK DC 180 Cassette Furnished.

PHONE RECORDING ADAPTER
Records calls automatically. All Solid state connects to your telephone jack and tape recorder. Starts recording when phone is lifted. Stops when you hang up. **\$24.50*** FCC APPROVED

VOX VOICE ACTIVATED CONTROL SWITCH
Solid state. Self contained. Adjustable sensitivity. Voices or other sounds automatically activate and control recorder. Uses either recorder or remote mike. **\$24.95***

*Add for ship & hdg. Phone Adapter & Vox \$1.50 ea. Recorders \$4.00 ea. Cal. Res. add tax. Mail order, VISA, M/C, COD's OK. Money Back Guarantee. Qty. disc. avail. Dealer inquiries invited, Free data.

AMC SALES INC. Dept D 9335 Lubec St., Box 928, Downey, CA (213) 90421 Phone 869-8519

CIRCLE 145 ON READER SERVICE CARD

WE'RE TRYING TO REACH YOU!

POPULAR COMMUNICATIONS

76 N. Broadway, Hicksville, NY 11801

Here's what you've been looking for - an all new hard-hitting monthly magazine which gives a unique insider's view of what's really going on in the world of communications. POP'COMM is your primary source of information - bigger and better than any communications magazine, with exciting coverage of scanners, shortwave broadcast & utility stations, spy stations, pirate and clandestine broadcasters, RTTY monitoring, survivalist communications systems, FCC news, wiretapping and bugging, scrambling/ unscrambling, surveillance/ undercover communications, satellite & cable TV, sophisticated telephones, & more. What you've been looking for all along! Take advantage of substantial savings over the newsstand price by subscribing now. Don't miss out on even one single issue of POPULAR COMMUNICATIONS - order your subscription now.

Yes! The NEW POPULAR COMMUNICATIONS is just the magazine I've been looking for. Start sending it to me now! I understand that I may cancel at any time for any reason, and receive a full refund on my unused subscription.

Paid by: Check Money Order MasterCard Visa
My account number is:

Name _____
Street _____
City _____ State _____ Zip _____

(Canadian and foreign subscribers add \$4.00 for each year. Foreign subscriptions payable ONLY in US funds by international draft or money order.)

- \$42.00 for 36 Issues
SAVE \$28.40
- \$29.00 for 24 Issues
SAVE \$17.80
- \$16.00 for 12 Issues
SAVE \$7.40

SUBSCRIBE NOW & SAVE!



All-Band Transmit Modifications

During a widespread emergency, it may become necessary to transmit on specific frequencies to signal for help or to pass emergency radio traffic. These frequencies might be monitored by the Civil Air Patrol, the National Guard, United States Coast Guard, the military, or other public safety agencies.

The well-equipped survival station should have complete access to receive all frequencies on the shortwave band, as well as many frequencies in the VHF and UHF spectrum. Modern worldwide amateur radio equipment not only tunes in the ham bands, but also allows for general coverage receive, and with modification, general coverage transmit. Modern VHF and UHF ham radio walkie-talkies also allow for VHF and UHF public safety band receive as well as public safety band transmit with the proper modification.

Before we get into modification details, let me first point out that using frequencies without FCC authorization could result in stiff penalties. This could include imprisonment, a \$10,000 fine for every day you are transmitting on the air, and the confiscation of your equipment. The only time you are allowed to use frequencies that you are not authorized is in a real emergency when safety of life or protection of property is an immediate threat. Possessing equipment that has been modified and is capable of transmitting outside of normal ham radio band limits is not necessarily illegal—but just as soon as you press the microphone in a non-emergency situation outside of your authorized frequencies, this indeed is not allowed. Just remember that operating on frequencies without specific FCC authorization is simply not legal except in an emergency.

The popular Yaesu 757 high-frequency transceiver is easily modified for all-band transmit. Simply locate the tiny white switch that is hiding under a wire bundle inside the top front of the set near the frequency selector mechanism. Simply slide the switch in the opposite direction, and your transmitter is now unlocked.

Yaesu 2-meter hand-helds are not capable of going beyond their normal 2-meter range, well outside of normal ham or MARS limits. You cannot extend it into the 150 MHz region.

The ICOM 02-AT 2-meter hand-held and the Kenwood 2600 hand-held will both go into the 150 MHz range if some modifications are made.

On the Kenwood 2600, locate the two diodes standing on end with Teflon covering the top part of their leads (which at one time



The ICOM IC-M700 is a ham and SSB marine transceiver.



Yaesu's popular FT-757GX transceiver.

were soldered together, broken, and then resoldered). Simply clip these two leads to unlock the transmitter, but be sure to reset the microprocessor by pushing the reset button before the set is capable of transmitting on any frequency at 150 MHz.

On the ICOM 02-AT, as well as on the ICOM 04-AT for VHF and/or UHF work, both units require semi-major diode surgery for frequency expansion. For VHF, two diodes are removed and three are added for the ICOM 02-AT to extend all the way up to 165 MHz. For UHF work, two diodes are added to extend the range of the ICOM 04-AT. The modification is tricky and a bit complicated. (Ten dollars to Radio School, 2414 College Drive, Costa Mesa, California 92626, brings you all the instructions plus all the diodes needed for either the VHF or UHF mod.)

The popular Kenwood TS430S is modified for all-band high frequency transceiver operation by unplugging the 3-wire plug on the RF board that mates with socket 10. When looking at the front top of the radio, it's to the left front side right beside a larger white plug. You'll need to carefully examine the circuit board and locate the number 10 with a circle around it to insure you have the right plug.

On the brand new ICOM 735, to unlock the transmitter you simply cut diodes D33 and D34 that are standing on end near the microprocessor section toward the rear top of the radio.

On the ICOM IC-745, locate the RF board on the side of the radio and cut the light brown wire at jack 7, which is going to pin 1. Your transmitter is now unlocked.

On the IC-751, locate the RF board on the side of the radio and cut the black wire going to pin 1 of jack 2. Your transmitter is now unlocked.

On the big Kenwood 940 base station, locate IC number 109. Now find diode 130 and cut it for all-band transmit. If you want

just MARS coverage, locate IC 111 and 112, and snip diode 135 beside it.

On the Kenwood 930, the all-band transmit modification is a bit more lengthy—several jumpers are required. Send a self-addressed envelope to Radio School (address previously given) with \$5.00 for complete instructions.

None of the 2-meter mobile sets are easily converted to 150 meg frequencies. Many people have tried all sorts of modifications, but the best they can get is 149.99—and nothing higher.

The ICOM thumbwheel VHF set, IC 2AT, can also be modified for 150 MHz transceiver; but once you make the mod, you lose all of your 2-meter frequencies. You would be better to simply go out and buy a type-accepted VHF transceiver as opposed to ruining your present 2-meter ICOM IC 2AT set!

The older high frequency radios with VFO tuning (as opposed to PLL tuning) do not easily allow any type of modification for expanded transmit or receive coverage. It would require so much modification that you would be ill-advised to try and step up any Yaesu FT101 series, 980, Kenwood 120, Kenwood 520, 820, or any of the old ICOM sets.

For the old ICOM 720, the transmitter is unlocked by snipping the blue wire that's at the very end of the top hatch cover to the left middle side of the transceiver.

On the ICOM M-700 marine transceiver, the sets are already capable of working on ham radio frequencies. Despite what the literature says, no lock-out is employed because the factory already did their diode trick. Simply punch in the frequencies and you're on the air. Remember, any ham frequency on 40, 80, or 160 meters requires the mode switch to be put to the hard left position of "A3," which enables the lower sideband filter. All other frequencies to include all marine frequencies are upper side-

band—including those marine frequencies at 2, 4, 6, and 8 MHz. All marine is upper sideband.

The well-trained survivalist will know the radio frequency band well to include radio operating procedures for different services. This will assist you if it becomes necessary to signal a radio call on these bands in an emergency.

Today's modern ham radio equipment gives us complete access to roam the airwaves and eavesdrop on almost any type of radio communications that are out there, on the air. CRB Research, P.O. Box 56, Com-mack, NY 11725, offers numerous confidential frequency lists of those agencies you may wish to tune into with your general coverage amateur radio transceiver to gain more information about local emergencies and local happenings. Write for their big free catalog.

While it's not illegal to modify amateur radio equipment for all-band transmit, it is illegal to use it if it's not an emergency. While you may possess a valid citizen's band radio license, using non-type accepted amateur radio equipment on CB bands is not allowed.

Although you may possess a marine radiotelephone license or an aeronautical license, using non-type accepted equipment on these bands is also not allowed, except in an emergency.

Take your time when modifying equipment, and use modified equipment outside of your regular band limits only in an emergency situation. **PC**

USE
YOUR

F
R
E
E

I
N
F
O
R
M
A
T
I
O
N

C
A
R
D

POPULAR COMMUNICATIONS FREE INFORMATION SERVICE

For further information on products, dealers, or literature in this issue, circle the appropriate numbers below. Be sure to include your name and address before mailing.

| | | | | | | | | | | | |
|-----|-----|-----|-----|-----|-----|-----|-----|-----|-----|-----|-----|
| 1 | 2 | 3 | 4 | 5 | 6 | 7 | 8 | 9 | 10 | 11 | 12 |
| 13 | 14 | 15 | 16 | 17 | 18 | 19 | 20 | 21 | 22 | 23 | 24 |
| 25 | 26 | 27 | 28 | 29 | 30 | 31 | 32 | 33 | 34 | 35 | 36 |
| 37 | 38 | 39 | 40 | 41 | 42 | 43 | 44 | 45 | 46 | 47 | 48 |
| 49 | 50 | 51 | 52 | 53 | 54 | 55 | 56 | 57 | 58 | 59 | 60 |
| 61 | 62 | 63 | 64 | 65 | 66 | 67 | 68 | 69 | 70 | 71 | 72 |
| 73 | 74 | 75 | 76 | 77 | 78 | 79 | 80 | 81 | 82 | 83 | 84 |
| 85 | 86 | 87 | 88 | 89 | 90 | 91 | 92 | 93 | 94 | 95 | 96 |
| 97 | 98 | 99 | 100 | 101 | 102 | 103 | 104 | 105 | 106 | 107 | 108 |
| 109 | 110 | 111 | 112 | 113 | 114 | 115 | 116 | 117 | 118 | 119 | 120 |
| 121 | 122 | 123 | 124 | 125 | 126 | 127 | 128 | 129 | 130 | 131 | 132 |
| 133 | 134 | 135 | 136 | 137 | 138 | 139 | 140 | 141 | 142 | 143 | 144 |
| 145 | 146 | 147 | 148 | 149 | 150 | 151 | 152 | 153 | 154 | 155 | 156 |
| 157 | 158 | 159 | 160 | 161 | 162 | 163 | 164 | 165 | 166 | 167 | 168 |
| 169 | 170 | 171 | 172 | 173 | 174 | 175 | 176 | 177 | 178 | 179 | 180 |

Insert issue date here

(month) (year)

(must be completed to process)

Name _____

Company Name _____

Address _____

City _____ State _____ Zip _____

Phone _____

ICF-2010

\$289.95

Plus \$3.00 UPS

LIST \$349.00 1986 catalog price \$299.00

TECHNOLOGY FEATURES

- **Dual PLL quartz frequency synthesis** — the world's most accurate tuning system; uses a quartz crystal's accuracy to abolish drift and maximize tuning stability
- **New synchronous detection circuitry** for the first time in a consumer radio, dramatically reduces fading and annoying "beat" frequency interference from adjacent stations
- **Switchable IF bandwidth**, "narrow" to select one station out of a crowded band, or "wide" for the lowest distortion when your station isn't fighting to break through the clutter
- **Built-in ferrite bar antenna** for LW and MW reception
- **Telescopic antenna** for FM and SW reception

SPECIFICATIONS

Frequency Range: AM: 150-29,999.9 kHz; FM: 76-108 MHz; Air: 116-136 MHz

Antenna System: LW, MW: Built-in Ferrite Bar Antenna; FM, Air, SW: Telescopic Antenna

Inputs: DC-In 4.5V, External antenna input (minijack x 2)

Outputs: Earphone (minijack), Record output (minijack)

Speaker: 4-inch dynamic

Power Requirements: Batteries "D" x 3 (4.5V) (optional), "AA" x 2 (3V) (optional) for programmable clock/timer; AC 120 Volts, 60 Hz with AC Adaptor (supplied); DC: 12 Volts with DCC-127A Car Battery Cord (optional)

Dimensions: 6 1/4" H x 11 3/8" W x 2 1/16" D

Weight: 3 lbs., 12 oz (with batteries inserted)

Color: Black

Supplied Accessories: AC Adaptor, Earphone, Shoulder Strap, Long Wire External Antenna, External Antenna Connector (x 2), Short Wave Handbook

Optional Accessories: DCC-127A Car Battery Cord, AN-1 Active Antenna

CONVENIENCE FEATURES

- **Full AM band coverage (LW, MW, SW, USB, LSB) plus FM and Air Band reception**
- **Band select** function for quick access to SW broadcast bands
- **Direct Access™ tuning** enables you to "key-in" station numbers directly
- **Rotary tuning knob** for smooth, convenient manual tuning up and down the band
- **32 station memory presets** for immediate recall at the touch of a button
- **Memory Scan tuning** gives a brief sampling of each preset



NEW! SONY RECEIVER

- **Automatic Scan tuning** gives a brief sampling of each station on the band
- **Built-in quartz clock** with standby and alarm capability
- **Programmable timer** turns receiver on and off automatically up to four times per day, tuning in up to four different stations
- **Sleep timer** for 15, 30, or 60 minutes of music as you go to sleep
- **Switchable 12-hour/24-hour clock** indication; 24 hour indication facilitates reference to Greenwich Mean Time (GMT)
- **Multi-function liquid crystal display (LCD)** indicates tuned frequency, preset station number, AM (LW, MW, SW) or FM, shortwave meter band, and more



SPECTRONICS INC

1009 GARFIELD STREET, OAK PARK, IL 60304

(312) 848-6777



WASHINGTON PULSE

FCC ACTIONS AFFECTING COMMUNICATIONS

Rules For Marine Radiodetermination Radar Transponders And Radio Beacons

In response to requests by Radar Devices, Inc., Marphonics, and Novatech Designs Limited, the Commission has proposed new rules to allow the use of radar transponders and radio beacons for marine radiodetermination services.

Coast and ship station licensees would apply to the Commission for a license to operate radar transponders on the marine radar bands for radiodetermination purposes after obtaining approval from the U.S. Coast Guard.

Ship station licensees would utilize specified Private Land Mobile Radio Services VHF and UHF channels for radiolocation and associated telecommand communications under their existing station licenses provided such communications are related to their commercial operations.

Aeronautical Enroute Administrative Messages Proposed

The Commission proposed expanding the scope of permissible communications in the aeronautical enroute service.

The proposed communications consist of administrative messages concerning the on-board provisioning of aircraft, passenger travel arrangements, and aircraft ground services for passengers. These administrative messages are transmitted digitally on a secondary basis on domestic VHF enroute frequencies.

Administrative messages of the kind proposed have been authorized by the Commission on a developmental basis for over two years by rule waiver. This rulemaking would regularize these messages by amending FCC rules.

The proposal came in response to a petition for rulemaking filed by Aeronautical Radio, Inc.

Paging Operators In Special Emergency Radio Service

The Commission recently received several complaints about radio interference from paging transmissions on frequencies authorized for two-way communications in the Special Emergency Radio Service. Most of this interference appears to be caused by licensees such as hospitals or ambulance companies who don't understand the difference between regular paging and secondary alert-paging. This explains the rules on

paging operations in the Special Emergency Radio Service so that licensees can avoid or correct paging interference.

Paging is defined in Part 90 of FCC rules as a "one-way communications service from a base station to mobile or fixed receivers that provide signalling or information transfer by such means as tone, tone-voice, tactile, optical readout, etc." Most paging receivers are popularly known as "beepers." In the Special Emergency Radio Service, this kind of paging may be authorized on any of 11 paging-only frequencies (in MHz):

| | | |
|-------|----------|---------|
| 35.64 | 152.0075 | 453.025 |
| 35.68 | 157.450 | 453.075 |
| 43.68 | 163.250 | 453.125 |
| 43.64 | | 453.175 |

Some of these channels are subject to other limitations, but none may be assigned for two-way communications.

Certain other Special Emergency frequencies that are assigned primarily for two-way communications may also be used for alert-paging on a secondary basis. They are designated in the frequency table under rule section 90.53 by limitation (25), which reads:

A licensee regularly conducting two-way communication operations on this frequency may, on a secondary basis, also transmit one-way alert-paging signals to *ambulance and rescue squad personnel* (emphasis added).

This means, for example, that a hospital or ambulance dispatcher may use a station licensed on such a frequency to alert drivers or medical teams to respond to a call. But the dispatcher first must make sure that the alert-page will not interfere with any other traffic on the frequency. No licensee first licensed after August 15, 1974, may operate a paging system on any frequency designated by limitation (25).

For more information about this subject, consult rule sections 90.35, 90.37, 90.53, and 90.55 (Paging operations), or call the Private Radio Bureau at (202) 632-6497.

Ultrasonic Pest Control Units Cause Interference

Ultrasonic Pest Control devices are devices advertised to chase away pests (i.e., mice, rats, roaches, etc.) by using noise that cannot be heard by people. These devices have been found to cause radio interference to TV reception as well as other types of equipment. The frequencies at which interference has been reported range from 20 to 470 MHz.

Ultrasonic devices of this type are subject to the technical and non-interference requirements of Part 18 of the FCC Rules (47 CFR Part 18). Although pest controls are generally not subject to an administrative re-

quirement, manufacturers of such devices are cautioned that the device is subject to the technical limits in Section 18.72 and non-interference requirement of Section 18.17 of the Rules.

In investigating one of these devices at the FCC Laboratory, the staff was able to determine that a minor technical change to the device would substantially reduce its radiated emissions and hence, its interference potential.

Simplified Application Procedures For Trunked SMRS Users

The Commission proposed amending Part 90 of its rules to simplify application procedures for users of trunked specialized mobile radio systems (SMRS).

The proposed amendments would relax certain requirements for end users to modify their mobile and control station licenses whenever there are changes to their associated SMRS base stations.

Specifically, this proposal would amend Section 90.135 to eliminate the need for SMRS users to file applications to modify their licenses in three instances: 1) when the associated SMRS base station license is assigned to another licensee; 2) when the SMRS increases or decreases the number of its assigned channels; and 3) when the user operates on more than one SMRS.

Present procedures require SMRS users in any of these instances to apply for station modification on FCC Form 574. Under the proposed procedures, they would simply notify the Private Radio Bureau's Licensing Division by letter.

These procedures would reduce the paperwork burden by about 5,000 applications per year and save the FCC the equivalent of one workyear in processing time, according to Bureau estimates.

FCC Form 610

On October 17, 1984, the Commission released a Public Notice alerting Amateur Radio Service applicants that a date would be set after which all previous editions of the FCC Form 610 (prior to June 1984) would no longer be acceptable for filing.

Effective January 1, 1986, only the June, 1984 and later editions of FCC Form 610 may be used to obtain an Amateur license. Applying on earlier editions of the form after January 1, 1986 will delay issuance of your license as your application will be returned without action and you will be required to re-file on a current form.

For further information contact the Consumer Assistance Branch, Private Radio Bureau, Gettysburg, PA 17325. Telephone number 717-337-1212.

Pirate Broadcast Stations Busted

On August 19, 1985, U.S. Marshals, under the direction of Assistant U.S. Attorney Steven Snider of Ft. Smith, Arkansas and accompanied by an investigator from the Dallas District Office of the Federal Communications Commission, served a warrant and seized radio transmitting equipment utilized by Russell E. Rierson of Boonesville, Arkansas. Rierson had been operating an unlicensed pirate station on various frequencies in the 6 and 7 MegaHertz short-wave broadcast bands. Close-in direction finding by FCC personnel from the Dallas Office revealed that the station, located at Rierson's residence, was operated on August 16, 1985, using a frequency of 7440 kiloHertz and identifying as "KBBR."

Investigators from the Dallas Office had previously located Rierson's unlicensed station, then identified as "KRZY" and "Captain Crazy," on March 9, 1985. Those illegal operations resulted in Rierson's payment of a \$1,000 administrative fine.

Rierson, if convicted, faces a maximum possible penalty of one year imprisonment, a fine up to \$10,000, and forfeiture of his equipment to the U.S. Government.

In another case, an investigator from the FCC's Kansas City District Office located an unlicensed broadcast station operated by Liam P. Ryan in Kirkwood, Missouri (a suburb of St. Louis). Mr. Ryan's unlicensed broadcast activity was terminated on August 9, 1985, just one week after his operation was first detected by the FCC monitoring network. Mr. Ryan was operating on a frequency in the 7 MegaHertz band. The Kansas City Office issued a \$1,000 Notice of Apparent Liability to Mr. Ryan for his unlicensed operation.

Persons operating an unlicensed broadcast station are subject to administrative fines or prosecution in U.S. District Court.

Reconsideration Of Action Requiring STL/ICR Stations

The FCC denied the Society of Broadcast Engineers and Service Broadcasting Corporation partial reconsideration of its 1984 action requiring Aural Broadcast Studio Transmitter Link and Intercity Relay (STL/ICR) stations operating under special temporary authority (STA) in the 942-944 MHz band to vacate within 5 years.

That action had reallocated the 944-947 MHz band for STL/ICR stations in the 50 states and the 942-947 MHz band for those in Puerto Rico. In addition, the Commission grandfathered already licensed stations in the 942-944 MHz band, but required some 56 stations operating in the band under STA to vacate within 5 years. The action was taken as a part of the 900 MHz reallocation package which allocated the 932-935 and 941-944 MHz bands for two-way fixed, government/non-government operations (Docket 82-243).

Notwithstanding the request of the Socie-

ty and Service Broadcasting that the Commission rethink its decision to remove STA stations from the 942-944 MHz band, the Commission noted they had submitted no new information sufficient to warrant reconsideration. It pointed out that the issues of congestion, relocation of stations affected by reallocation of the band and the economic impact on stations required to relocate had all been discussed during the proceeding; and due consideration had been given to various interests.

The FCC said it felt that most, if not all, of the temporary STL/ICR stations, along with station growth, can be accommodated in the 944-952 MHz band if careful equipment design and local frequency coordination is used.

Spectrum Allocated For Radiodetermination Satellite Service

The Commission has allocated frequencies in the 1610-1626.5, 2483.5-2500, and 5117-5183 MHz bands for use by a newly formed Radiodetermination Satellite Service.

This new service will provide radiodetermination and associated message transfer services to a variety of users, including land and water craft and pedestrians requiring location information and the ability to send and receive short alphanumeric messages. The service could provide routine navigational information and would be potentially useful during accident and emergency situations.

Last July, the Commission had proposed allocating three frequency bands to establish a radiodetermination satellite service, in response to the request of Geostar Corporation. The 1610-1626.5 MHz band was to provide for the radiodetermination user uplink to geostationary satellites. The 2483.5-2500 MHz band has to provide for the radiodetermination downlink. And the 5117-5183 MHz band was to be used as a communications link from each satellite to a central control facility to handle the computational functions for the system.

Whereas Geostar had requested 16 MHz of spectrum in the 6425-7075 MHz range for an uplink to transmit command and message traffic from the central control facility to each of the geosynchronous satellites within the system, the FCC had suggested the use of the 6525-6541.5 MHz band, already allocated to the fixed and fixed-satellite (earth-to-space) services for this purpose.

The Commission noted that all existing fixed stations licensed as of July 25, 1985, will be grandfathered in the 2483.5-2500 MHz band and may continue operations, subject only to license renewal, on a primary basis along with the Radiodetermination Satellite Service. Existing mobile stations also will be grandfathered on a primary basis; but licensees in the Radiodetermination Satellite Service will have the option of reimbursing mobile licensees for relocating to other frequencies should the mobile opera-

tions cause unacceptable interference. However, no additional operations for fixed and mobile stations will be authorized in this band.

FCC Chairman Fowler Submits Bill Proposing Auctions To Assign Initial FCC Licenses

FCC Chairman Mark S. Fowler sent to the Congress the draft of a bill which would give the FCC authority to use auctions in the assignment of initial licenses. Auctions could be used in all services except those involving media of mass communications, public safety, and amateur services.

Citing the "severe drawbacks" of the present methods for selecting licensees from among mutually exclusive applicants—comparative hearings and lotteries—Chairman Fowler pointed out that auctions could:

- Assign channels to the user(s) who can put them to their highest valued use without need for resale
- Reduce the budget deficit by raising substantial revenues for the U.S. Treasury, providing a benefit to the general public
- Reduce the amount of society's resources (primarily legal and engineering expenses) used in preparing applications
- Lower administrative costs by weeding out frivolous applicants who have no intention of operating but only hope to gain through reselling a license won in a lottery or being bought out before the lottery even takes place.

Chairman Fowler emphasized that the proposed auctions would be narrowly circumscribed in six important ways.

First, the proposed legislation would not alter in any way previous allocations of spectrum or the Commission's obligation under the Communications Act to allocate spectrum to those uses best calculated to promote the public interest.

Second, under the auction system, the terms, conditions, or rights of the license would be the same as those applied to licenses obtained through comparative hearing or lottery.

Third, the FCC's auction authority could be used only for unassigned spectrum. Existing licensees who have already received assignments would not be affected.

Fourth, the auction process would not be used for licensing any medium of mass communications, since the Commission has no desire to disrupt the present licensing system. Nor would it affect the public safety or amateur services.

Fifth, since there is little experience with the use of auctions in the federal licensing process, Chairman Fowler proposed limiting the FCC's authority to a five-period, at which time a Report would be made to Congress and an assessment of the program would take place.

Finally, all revenues raised through the use of auctions would be directed to the general funds of the U.S. Treasury. **PC**

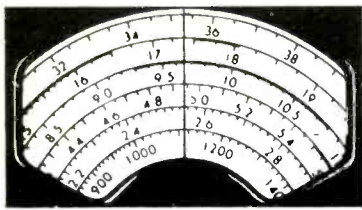

COMMUNICATIONS CONFIDENTIAL

BY MIKE CHABAK

YOUR GUIDE TO SHORTWAVE "UTILITY" STATIONS

My thanks to Bob Ross of London, Ontario Canada for providing me with the following information.

In October 1983, NOAA established the Office of Aircraft Operations. The function of the OAO was to consolidate management and operational aspects of the Dept. of Commerce's NOAA aircraft fleet. One part of this fleet is the light aircraft group. In its inventory are Bell UH-1 helicopters, plus several Rockwell Shrike and Turbo Commander twin engine aircraft. These helos and aircraft provide general support for NOAA operations, as well as participating in certain overland research projects. These NOAA aircraft will normally only be heard on VHF/UHF.

The NOAA aircraft that are of more particular interest to the HF monitor use the callsigns NOAA 42 and NOAA 43. Both are WP-3D Lockheed Orion aircraft, having the same basic airframe as the U.S. Navy's P-3C Orion long range patrol aircraft. The NOAA WP-3D types have the following modifications, which can be seen in the illustration. In addition to the standard nose radar, the NOAA aircraft carry a belly "dust bin" radar under the forward fuselage, and replacing the Navy MAD tail boom is a small, elliptical shaped, steerable radar in a bullet-like tail cone. The boom projecting from the starboard side of the nose is not an air refueling device, but a support for gust probe sensors.

The NOAA WP-3D aircraft are home-based at Miami International Airport. From there, they conduct a variety of missions. We are all familiar with their hurricane probings, but these aircraft also participate in other U.S. and international meteorological/oceanographic research programs. Hence, they can be encountered on the HF bands, any time of the year. NOAA has apparently retired NOAA 41, which was a WC-130 Lockheed Hercules.

NOAA 42/43 can be heard on the commercial aeronautical frequencies working ATC ground stations, and at other times on the USAF GCCS frequencies, often running phone patches to Miami Monitor. In many instances, the NOAA aircraft can be heard directly working KJY-74 Miami Monitor, which is the National Weather Service operations center in Miami, Florida. When so, they conduct simplex USB voice comms on the following frequencies: 3407, 5562, 6673, 8876, 10015, 13354, 17901, and 21937 kHz.

As Mr. Ross obtained QSLs from NOAA 42 and KJY-74, it is quite apparent that

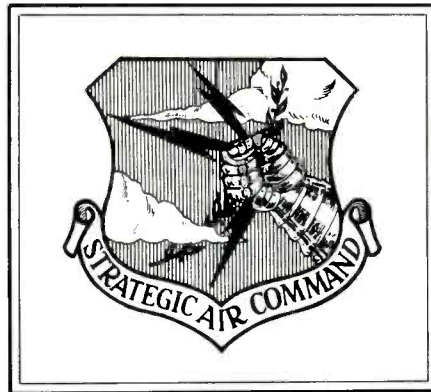

A look at an SWL card from an Italian listener, Lino Brignoli of Milan.

NOAA will verify, providing that you supply a PFC. Mailing addresses are the same, with the exception of the appropriate header. This would be either: NOAA/NWS, Miami Monitor Communications KJY-74 or Aircraft NOAA ##, c/o; the remaining address is: Chief of Communications, NOAA/OAO, P.O. Box 020197, Miami, FL 33102-0197.

Strategic Air Command Comms

We're going to devote the remainder of this column to a discussion of SAC communications. Many a newcomer to the utilities stumble onto SAC and are intrigued by what they hear, but often can make little sense of most of what transpires. Others, having been frustrated by what they could not readily comprehend, shy away from the SAC frequencies. The purpose of this discussion will be to familiarize you with the basics, so as to give you a better understanding of what is going on.

In order to accomplish this, I will illustrate the discussion with various examples that include tactical callsigns and messages. I wish to make quite clear the following: although most of the callsigns are those that have been actually heard, they have been picked

at random and used out of context. No genuine SAC messages will be repeated; instead their actual formats will be illustrated with "made up" material. This must be done in order not to violate Section 605 and other regulations pertaining to disclosure of utility or otherwise classified communications. Before we get into SAC comms, it would be useful to give a brief rundown of the SAC forces.

SAC Forces

SAC is a major command of the United States Air Force, whose role is primarily that of nuclear deterrence, and if that fails, nuclear retaliation. SAC represents two-thirds of the U.S. nuclear triad force, these being manned bombers and silo launched ICBMs. The U.S. Navy fleet ballistic missile submarines make up the third part of this triad system.

Bombers

SAC's primary bomber is the Boeing B-52 Stratofortress, in either the G or H model. Most are equipped to carry up to 20 AGM-69A SRAM (Short Range Attack Missile) or a mix of SRAMs and free falling nuclear bombs. Recently, a portion of the B-52G force was modified to carry the AGM-86 ALCM (Air Launched Cruise Missile) and as the Rockwell B-1B enters, most of the G/H models will be so converted to a cruise missile launch platform.

But not all SAC B-52s are so equipped. A portion of the G model force are designated to carry non-nuclear bombs, to act in a conventional rather than nuclear role. In addition, 30 B-52Gs are equipped to carry aerial mines and the air-to-surface Harpoon missile. These B-52 units are used to support U.S. Navy and NATO maritime warfare/ocean reconnaissance operations.

One hundred Rockwell B-1B bombers are in the process of entering SAC inventory, with all due in by 1988. The B-1B will be capable of carrying SRAM/ALCM and free falling nuclear bombs, deliverable from low altitudes at near sonic speeds.

The last bomber type in SAC is the General Dynamics FB-111A. This is the strategic bomber version of the USAF swing wing F-111 interdiction fighter. It can carry free falling bombs and/or SRAMs for low level, sonic speed delivery.

Tankers

Over 600 Boeing KC-135 Stratotankers comprise the bulk of the SAC aerial refuel-

GILFER SWL BEST-SELLERS



ICOM R71A – only \$599!

The DX machine, with 100 kHz to 30 MHz tuning. Quad conversion, direct-feed mixer with 100 dB dynamic range, two VFOs, direct frequency entry keyboard, 32 memories, switchable preamp, passband tuning, IF notch filter, noise blanker. Options in stock: Voice Synthesizer, high stability xtal, 500 Hz CW filter, infrared remote control, high grade ssb filter, 12v dc power, FM tuner, GILFER mods.



YAESU FRG-8800 – only \$499!

Microprocessor controlled tuning, mode select, triple scanning, memory, and clock functions. Covers 150 kHz to 29.999 MHz. Features LCD display for frequency and signal meter, computer interface, keyboard entry, 12 memories, noise blanker, squelch, tone, attenuator, programmable clock control. Options are VHF converter, active antenna, antenna tuner, 12v dc supply, FM narrow unit, GILFER mods.

CALL FOR PRICE



NEW JRC NRD-525 Receiver

Dual conversion PLL circuitry tuning .09-34MHz. Panel readout of all functions; 200 ch. memory; pushbutton mode select (RTTY, CW, SSB, AM, FM, FAX); bandwidth 4/2kHz std.; scan/sweep receive; noise blanker; notch filter; attenuator; AGC; BFO; Squelch; RF & AF gain; front panel phone & record jacks; clock/timer; optional: 34-60MHz, 114-174, 423-456 converters; RTTY Demod; RSC-232 interface.



GILFER CARRY CASES –

Take your portable receivers and accessories along in these waterproof padded cases. Small \$29.95; large \$32.95. \$4 USA, \$5 overseas, surface.



"Confidential Frequency List" 6th ed., 2nd printing. Compiled by O.P. Ferrell of GILFER. Best list of secret stations. \$15.95



"World Broadcast Station Address Book." New 5th ed.; 1150 station addresses, how to get QSLs, costs, starter list; 128p. \$8.95

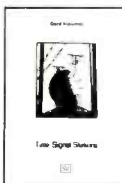

"Time Signal Stations." New 10 ed., 84p, spells out various time measurements, lists all stations/addresses worldwide. \$4.95

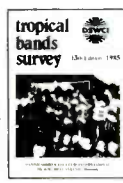

"Tropical Bands Survey." Latest ed. from Danish SW Clubs Intl. lists brst. stations, 2000-5000 kHz, with scheds, locations etc. \$4.50



"Radio Beacon Handbook." 252p. listing of over 9000 mw and lw radio beacons (150-1900 kHz); inc. call signs, freq., etc. \$14.95



"Medium Wave (IRCA) Almanac." Insiders book for 540-1600KC DX; talk programs, music, religious, football, baseball, \$9.00



"Radio Receiver-Chance or Choice." Tests of 75 top receivers by radio engineer R. Lichte for easy, accurate comparison. 256p. \$18.50



"The World Is Yours." Perfect intro to SWL, what it's all about, easy to understand layman's guide, great gift. \$2.95

Add \$1.50 shipping on first book, add .50 for each extra book.

GILFER SHORTWAVE • 52 Park Ave. • Park Ridge, NJ 07656 • Ph 201/391-7887

CIRCLE 120 ON READER SERVICE CARD

JOHN J. MESHNA JR., INC.

P. O. Box 62 E. Lynn, Ma. 01904 (617)-595-2275

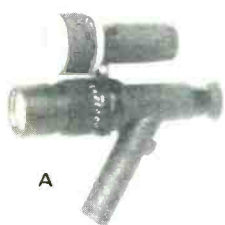

Meshna IR & Starlight Night Scopes
Night Vision for Sporting Purposes
Security & Surveillance
Nature Studies
Lab & Photo Studio Work



A) InfraRed Scopes. We have several IR scopes available. Pictured is one of our long range scopes shown w/ optional IR source. It features an 18mm tube, 10X eyepiece, 135mm f 2.8 lens w/ an internal nicad battery. It is a very versatile, compact instrument weighing only 24 oz.. It requires an external IR source for night vision. We offer 2 IR sources. A medium range, clamp on unit w/ internal batteries (approx 75 ft. range) and a handheld unit w/ an output of 200,000 candlepower for max. IR viewing which requires an external 12v battery pac (gel pac or equivalent).

Long Range IR scope SPL-133B-41 \$425.00
Medium range IR source SPL-135C-41 60.00
Handheld long range IR source SPL-136A-39 125.00

B) Second Generation Starlight Scope. Perfect for night surveillance. It uses an 18mm 2nd. Gen. intensifier tube, coupled w/ a 2x eyepiece 135mm f/2.8 lens, internal high voltage supply and rechargeable nicad batteries. It weighs only 24 oz.. 30 day warranty. List price \$2795.00
2 nd Gen. Starlight scope SPL-156A-41 \$1750.00
Fitted carrying case for above SPL-156B-41 \$ 65.00

Phone orders accepted on MC, VISA, or Amer. Exp. cards. No COD's. Hours: 8 AM-4:30 PM M-F Sat, 9 AM-1 PM (617) 595-2275
Free 72 pg. catalogue available or send \$1.00 for 1 st class service.

CIRCLE 135 ON READER SERVICE CARD

THE MONITORING MAGAZINE

★ QUALITY PARTS ★ DISCOUNT PRICES ★ FAST SHIPPING!

SEND FOR FREE NEW 1986 CATALOG. 48 PAGES!

ALL ELECTRONICS CORP.
905 S. VERMONT • P.O. BOX 20406 • LOS ANGELES, CA 90006

10 AMP SOLID STATE RELAY

CONTROL: 3-32 vdc
LOAD: 140 vac 10 amp
SIZE: 2 1/2" x 1 1/4" x 3/8"

\$9.50 EACH 10 FOR \$90.00

REGULATED POWER SUPPLY

13.8 VDC

These are solid state, fully regulated 13.8 vdc power supplies. Both feature 100% solid state construction, fuse protection, and L.E.D. power indicator. U.L. listed.

2 amp constant, 4 amp surge \$18.00 each
3 amp constant, 5 amp surge \$25.00 each

RECHARGEABLE NI-CAD BATTERIES

AAA SIZE| 25V 500MAH \$1.85
AA SIZE | 1.25V 500MAH \$1.85
AA with solder tab \$2.00
C SIZE | 1.2V 1200MAH \$3.50
D SIZE | 1.2V 1200MAH \$3.50

CASSETTE MECHANISM

New, stereo cassette mechanism Includes record/playback and erase heads, 2-12VDC motors drive belts, pulleys, 3-12VDC solenoids, pinch wheels and other mechanical parts. These parts, used on other current model decks, would cost several times our selling price if purchased separately. 5 1/4" X 3 1/2" X 3 1/8"
\$7.50 EACH 2 FOR \$12.50

EDGE CONNECTORS

ALL ARE 1.56" SPACING.

22/44 EDGE CONNECTOR PC style \$2.00 each
22/44 EDGE CONNECTOR solder lug style \$2.50 each
28/56 EDGE CONNECTOR PC style \$2.50 each

COMPUTER GRADE CAPACITORS

2,000 mfd. 200 VDC 1 3/4" DIA x 5" HIGH \$2.00
3,600 mfd. 40 VDC 1 1/8" DIA x 3 1/4" HIGH \$1.00
6,400 mfd. 60 VDC 1 3/8" DIA x 4 1/4" HIGH \$2.50
9,700 mfd. 50 VDC 1 3/8" DIA x 4 1/2" HIGH \$3.00
31,000 mfd. 15 VDC 1 3/4" DIA x 4" HIGH \$2.50
72,000 mfd. 15 VDC 2" DIA x 4 3/4" HIGH \$3.50
185,000 mfd. 6 VDC 2 1/2" DIA x 4 1/2" HIGH \$1.50

ULTRA-MINIATURE 5 VDC RELAY

Fujitsu # FBR211NED005M20
High sensitivity COIL: 120 ohms \$1.25 each
CONTACTS: 1 amp 10 for \$10.00
Mounts in 14 pin DIP socket

TOLL FREE ORDERS

1-800-826-5432
(IN CA: 1-800-258-8666)
INFO • (213) 380-8000
TWX - 5101010163 ALL ELECTRONIC

MINI-PUSH BUTTON

S.P.S.T. momentary normally open 1/4" x 1 1/8" hole Orange lens 16 amp contact \$1.50

MINI-PUSH BUTTON S.P.S.T. momentary normally open 1/4" bushing Red button 35¢ each 10 for \$3.00

● QUANTITIES LIMITED ● MINIMUM ORDER \$10.00 ● USA \$3.00 SHIPPING NO COD ● FOREIGN ORDERS INCLUDE SUFFICIENT SHIPPING ● CALIF RES ADD 6.12

CIRCLE 118 ON READER SERVICE CARD



QSL

Defense Civil Preparedness Agency
Radio Station / WGU 20 / 173 Kiloertz
1st 50 KW / All Solid State AM Transmitter
Chase, Maryland

This WGU20 QSL card was received a few years ago by one of our readers. Bet you didn't know the station had its own QSL card!

ing force. Most are Air Force, although a percentage are assigned and flown by the Air National Guard and Air Force Reserve units. Sixty McDonnell Douglas KC-10A Extenders are now entering the inventory to meet the needs of an advanced tanker/cargo aircraft for SAC.

Recon

The strategic reconnaissance role is carried out by the Lockheed SR-71, along with several models of the Lockheed U-2 and TR-1. SAC also maintains a force of modified KC-135s, designated as EC or RC-135, in various models. The most famous model is the EC-135C, which fulfills the role of the SAC ABNCP.

Strategic Missiles

The LGM-25C Titan 2 missile is in the process of being phased out. Twenty-nine are still in silos, but all will be deactivated by 1987. The primary ICBM is the LGM-30 type Minuteman 2/3. There are 450 LFM-30F and 550 LGM-30G Minuteman missiles in underground silos.

SAC hopes to deploy 100 LGM-118A Peace Keeper ICBMs (the MX missile) by 1989. Still in research and development is the small ICBM (Midgetman) designed for mobile rather than fixed silo launch. In brief, these are the aircraft and missiles of SAC. I

mention them, for you can hear virtually all on SAC HF frequencies.

Airborne Alert

During the years 1957 through 1968, a portion of the SAC bomber fleet was always airborne, carrying nuclear weapons. This was our insurance that in the event of a surprise attack, part of the B-52 force would be in the air, ready to retaliate. During this era, several nuclear armed B-52s crashed. The bombs' built-in safeties insure that even after falling 40,000 feet and impacting the ground, they would not detonate, but probably break up, scattering the radioactive material. This was not the best of all situations, so with the coming of more sophisticated radars and early warning satellites, SAC modified the policy. Today, no SAC bomber flies with nuclear weapons. Instead, a portion of the bomber force is armed, but kept on ground alert. These armed bombers never leave the ground, except for a genuine alert. As such, any SAC bomber you see or hear on SAC frequencies is unarmed, flying training/exercise missions.

Giant Talk

This now brings us to SAC comms, which is known as the "Giant Talk" net. All SAC comms are considered classified, and as such, details on specific aspects are not public knowledge. Therefore, some of what follows is based on guess work.

The Giant Talk network has been active for many years. During this time communication procedures have undergone many changes. In previous years, the "Skyking do not answer" broadcasts were comprised of X-number of alpha numeric characters per transmission. These were transmitted every 15 minutes (and stateside); you could hear the message being repeated by four different stations. Actually, these were the four CONUS SAC ground commstas, but there were an additional ten scattered throughout the world doing the same thing. The four CONUS stations were located at Offutt, March, Barksdale, and Westover Air Force Bases.

Things have changed. The first change was a modification of the USAF "Airways" net. These stations were relieved of military ATC duties and incorporated into a global communications command and control system. Most of these former airways stations now, in addition to other duties, support SAC operations. The second aspect is that SAC is currently undergoing a plan called "Scope Signal 3." It is basically a communications and equipment modernization program. Currently, there are 12 worldwide SAC ground commstas. These are located at: Offutt AFB NE (SAC HQ), McClellan AFB CA, Andrews AFB MD, Elmendorf AFB AK, Thule AB Greenland, RAF Croughton UK, Incirlik AB Turkey, Clark AB Philippines, Yokota AB Japan, Kadena AB Okinawa, Andersen AFB Guam, and Hickman AFB Hawaii. Once Scope Signal 3 is completed, the commstas will be reduced to nine. From SAC HQ itself, here is an explanation of the Giant Talk network:

"... Giant Talk is a high frequency single sideband radio system that provides a means for positive control of the SAC airborne force. Its prime function is transmission of emergency action messages to SAC aircraft launched under positive control. Giant Talk also provides positive control communications for day to day control of aircraft reconnaissance operations. The system consists of 12 stations worldwide and is accessible from the SAC and numbered Air Force command posts, and other selected locations..." To this we could add that the Giant Talk net also is a communications medium in support of the ICBM force, and for SAC training/exercise missions.

Chain Of Command

To obtain a better feel for the complexity of the communications, let us look at the chain of command. At the very top is the President of the United States and the Joint Chiefs of Staff. This is the National Command Authority. For more practical radio monitoring purposes, it starts with SAC HQ located at Offutt AFB NE. Offutt is the Giant Talk master net control station. Its transmitter is located near Elkhorn NE and the SAC command and control center itself is some 45 feet underground at Offutt. Contrary to popular belief, the NORAD/Space Command Cheyenne Mountain complex only supports SAC and is not the C&C center for SAC operations.

Next in line is the 8th Air Force, headquartered at Barksdale AFB LA, and the 15th Air Force, headquartered at March AFB CA. Each, in turn, commands several Air Divisions. Under the air divisions are the individual SAC air force bases and their bomb/air refueling/recon/missile wings.

SAC Frequencies

SAC has used the same basic frequencies and associated channel idents for many years. As such, the more active freqs/idents are well known, yet because of the cryptic nature of SAC comms, SAC feels secure that public knowledge of them constitutes no danger.



A detailed illustration of a NOAA WP-3D research aircraft.

SAC uses 50-plus channel designators for its HF frequencies. Not all channel/frequency relationships are known or otherwise have previously been presented in a public access publication. Due to the mission of SAC, it is an unquestioned fact that they utilize many hundreds of HF frequencies, most being for specialized/specific applications, and therefore of a discrete nature. The following is a list of the basic frequencies and channel ident. Those marked with a * indicate the most active air/ground circuits.

- 4495-ECHO
- *4725-VICTOR
- 5700-BRAVO QUEBEC
- *6761-QUEBEC
- 7330-XRAY
- 8101-ALFA PAPA
- *9027-ROMEO
- 9057-PAPA
- 11220-BRAVO
- *11243-ALFA
- 11408-YANKEE QUEBEC
- 11494-LIMA
- 13211-BRAVO WHISKEY
- *13241-SIERRA
- 13907-ALFA CHARLIE
- 14955-CHARLIE
- 15035-CHARLIE QUEBEC
- *15041-MIKE
- *17975-TANGO
- 18594-ZULU
- *20631-WHISKEY
- 20890-DELTA
- *23337-UNIFORM
- 27870-DELTA QUEBEC

SAC Messages

Currently there are two main types of SAC message broadcasts. These are made by SAC ground commstas, and can also be from ABCP type aircraft. The first type I'll illustrate with this example: "Skyking, Skyking do not answer . . . Tango Alfa November . . . time 15 . . . authentication Bravo Lima. I say again, Skyking, Skyking do not answer . . . Tango Alfa November . . . time 15 . . . authentication Bravo Lima . . . Subsonic out."

Portions of the Skyking DNA are easy to understand. The time refers to the minute past the hour the message was being transmitted. The authentication is just that. Any SAC unit that monitors the broadcast will check the day code to ascertain the two letters which (we presume indicates what) are valid for that particular hourly period.

Neither the Department of the Air Force nor SAC has ever given an explanation of what "Skyking, Skyking do not answer" itself refers to. A bit of common sense can be applied here. The word "Skyking" serves as a message routing indicator, and in this case, Skyking means "to all U.S. nuclear forces and support units." It being a force wide broadcast, the "do not answer" reference is self-explanatory. The current Skyking DNA always contains three characters. Most often it is all phonetic letters, but can also be a combination of two letters and one

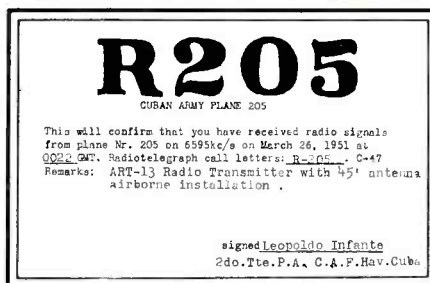

Here's a rare one, a QSL from the Cuban Air Force. It's from pre-Castro days (1951). Not much chance of getting one of these anymore. (Courtesy Tom Kneitel)

number. What these three characters refer to is unknown, but they are important enough to have their own separate broadcast and format. They are of an itemized reference nature, and being of only three characters, can be decoded rapidly. This fast decoding capability is apparently the prime factor for this short message format.

A pure hypothetical guess is that part of the DNA reference refers to the DEFCON status. DEFCON stands for Defense Condition. It has five categories, counting down from five to one. DEFCON FIVE refers to normal peace time force readiness. This force readiness increases down to DEFCON ONE (max force readiness), which for all practical purposes is the start of World War III. Other than this, it is unknown what the Skyking DNA messages can refer to.

The current Skyking DNA transmissions are made roughly once every hour, unlike once every 15 minutes previously. It is transmitted by one commsta and often "echoed" (repeated) by one or more other commstas immediately afterwards. How many commstas you hear sending a Skyking DNA depends on your QTH, time, and frequency. Skyking DNA transmissions can be updated at any time, and it is not unusual to hear several different message texts during a one hour interval. The Skyking DNAs are simulated over those frequencies associated with air/ground comms, as well as frequencies ranging from VLF through UHF.

EAM/CTM

The second SAC message broadcast is the EAM or Emergency Action Message. This in itself is misleading, since this takes in everything from an actual alert to training exercises. Aircraft often request this broadcast and refer to it as the "current traffic message." Its typical format when broadcast by a SAC commsta is: "MIKE LIMA FIVE HOTEL ALFA, standby . . . MIKE LIMA FIVE HOTEL ALFA, standby . . . Message follows, MIKE LIMA FIVE HOTEL ALFA (followed by phonetic letters and numbers. The entire text can range from 15 to 40 characters) "I say again, (repeats the entire message, minus the standby prologue) . . . Subsonic out."

The current traffic message (CTM) may remain unchanged for three or more continuous hours. What it is referring to is unknown, but like the Skyking DNA, it is an

itemized reference format. Often when an aircraft missed a character or two, it would ask the commsta to repeat item or element so and so. The CTM is for all U.S. nuclear forces, SAC and USN. The Navy records the EAM/CTM and then rebroadcasts it over certain Navy circuits. It is to be noted that although the USAF and USN are separate military services following their own game plan, their nuclear retaliatory strike units operate as a single entity under one unified command.

As I said, aircraft often request the CTM. Usually it follows this procedure: CANDY 45 contacts SUBSONIC and reports "ops normal, negative relay" (requesting the CTM takes many forms). "Request current traffic/HF traffic/current message and so on." The ground commsta would typically respond with "are you in receipt of Mike Lima Five?" (or sometimes all first five characters). If the reply is negative, the commsta transmits the entire CTM, minus the standby prologue.

The CTM (or EAM if you prefer) on face value seems to be transmitted irregularly, but such is not the case. A new updated EAM/CTM is broadcast as it becomes available from the National Command Authority (same with the Skyking DNA). There are specific time periods allotted to certain commstas for the transmission of these messages. On-the-air monitoring reveals these time slots to be referred to as the Alfa Monitoring Period. They are two minute slots per commsta, and occur in six minute time spreads, starting at 00, (plus) 15, 30, & 45 minutes.

When a new Skyking DNA or EAM/CTM is first broadcast, often it will be prologued: (example) "BARN DOOR, BARN DOOR this is SUBSONIC, SUBSONIC . . . Request you echo the following . . ."

Again, what the EAM/CTM refers to is unknown. During a genuine alert, the EAM would obviously be specific directives. Routine CTMs probably include current force activities, such as training exercises in progress. Beyond this guess, there are an infinite number of possibilities.

Next month, in the second part of this special 2-part report on the SAC, we'll look at SAC call signs and tactical ID's, the airborne command posts, recon aircraft, the communications formats, weather formats and other aspects of this complex worldwide network. Watch for it in the April issue!

Intercepts Section BY DON SCHIMMEL

Anchorage, Alaska is where reader Gary Bledsoe has written from, and he provided a fine batch of loggings. He commented in part: "I'm kind of excited with DX'ing in Alaska—I have been here a month and have logged 61 different ute countries—I would like to correspond with other Alaskan DXers and can be contacted at 3601 C Street, Suite 576, Anchorage, AK 99502-0333."

Reader George Osier, New York has forwarded many interesting intercepts plus a neat QSL card which he uses for his recep-

tion verifications. George also had a query about an RTTY activity he picked up one day. I recently spent most of a day following this network, so I will offer some comments instead of passing the item to RTTY Editor Bob Margolis. My apologies, Bob.

The net in question was the Inter-American Naval Telecommunications Network. This communications structure handled the traffic for the 1985 Inter-American War Games held in October 1985. The two opposing military forces were the "White Force" (the good guys) and the "Green Force" (the bad guys). The Commander of the White Force was located at the Naval War School in Rio de Janeiro, Brazil, as was the Control Group for the games. The latter apparently functioned as supervisors of the games.

RTTY and CW transmissions were observed and it was extremely interesting to sit in on this training exercise. On the day I watched the activity, my printer ran almost continuously and I had a paper pile-up just about knee high.

For those of you who might wish to check this network at a future date, I am listing some callsign and frequency details:

| Call | Location |
|--------|------------------------------------|
| CCQ | Iqueque Naval Radio, Chile |
| CXR | Montevideo Armada Radio, Uruguay |
| HDN | Quito Naval Radio, Ecuador |
| HIWF-1 | Santo Domingo Naval Radio, DR |
| LOL | Buenos Aires, Argentina |
| NBA | Balboa, Panama (U.S. Navy) |
| OBC | Callao Naval Radio, Peru |
| PWZ | Rio de Janeiro Naval Radio, Brazil |
| YWM-1 | Maracaibo Naval Radio, Venezuela |
| ZPK | Asuncion, Paraguay |
| 5KM | Bogota Naval Radio, Colombia |

The RTTY transmissions were 75 baud and 850 Hz shift and a number of frequencies were observed in simulcast as follows: 11570, 12182, 13371.5, 16194, 19616 kHz. The frequency of 20741 kHz was mentioned in operator chatter, but I did not hear any related signals there. The frequency 14430 kHz was carrying traffic that appeared to be related to Inter-American military matters, so perhaps this is another assigned frequency.

The CW frequencies of 13555 and 17590 kHz were checked infrequently because I was more involved in watching the RTTY traffic as the events of the games were taking place.

The U.S. Navy at NBA Balboa acted as the major communications relay point for the IAWG-85 traffic. A listing of QSL times showed that some countries were experiencing extremely long delays in the reception of some messages. Also, on the day I tracked the activity, NBA suffered several power or equipment failures and these factors combined to cause numerous repetitions being required for many messages.

I now wish I had spent some more time

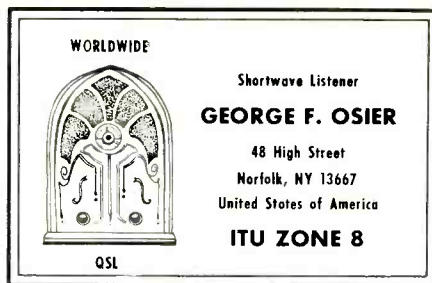

monitoring the network during the period of the games. It was extremely interesting to follow the activity and I am looking forward to the next such exercise and hope I will be able to perform a more complete and comprehensive coverage at that time.

One of our readers, Jerry Shiviskis, New Jersey has come in with a request for an explanation of a transmission he copied. The CW signal was the calltpe of NMR USCG Station at San Juan PR and looked like this: "CQ CQ CQ DE NMR NMR GF WX IMI AMVER IMI QSX 12 MHZ." Jerry, if the GF you copied is correct, I would have to guess that NMR was asking for General Forecast Weather details from ships. I must confess I had not seen that abbreviation before, so I may be all wet. The AMVER designation stands for Automated Mutual-Assistance Vessel Rescue System. In 1955, this system was established by the U.S. Coast Guard and it is a computer controlled means of storing data furnished by ships, which lists their destination, course, and speed. When an emergency at sea happens, it is possible for the concerned shore station to be informed of those ships that are near the stricken vessel and could thus offer assistance.

The AMVER master computerized file is at the U.S. Coast Guard base at Governor's Island, New York. Participating maritime mobile shore facilities forward the information received from ships to that location.

George Green, Georgia has furnished a description of an unusual transmission. Here are his comments: "I was monitoring the 8 MHz band around 0700 GMT and I received the most interesting but brief broadcast. (Ed. Note: Only one end was heard). The speaker had a British accent and his side of the conversation went as follows: 'ARCHITECT, ARCHITECT THIS IS BUCKET IN THE RUBBLE, ARE YOU READY FOR GARBLE?' Then there were several short bursts of garbles, each about one second in length. The conversation continued: 'ARCHITECT THIS IS BUCKET IN THE RUBBLE, DID YOU COPY GARBLE?' A couple seconds of silence then: 'GO TO SECOND BLUE CHANNEL.' Then silence."

Intercept Log

| | |
|------|--|
| 209: | SYS, Somerset PA, beacon 1818 (Jeff Hollis, WV) |
| 216: | CLB, Caroline Beach NC, beacon at 1824 (Hollis, WV) |
| 245: | LUA, Luray VA, beacon at 1828 (Hollis, WV) |
| 248: | KZ, Buttonville, ON, beacon at 0057 (George Osier, NY) |
| 257: | CGE, Cambridge MD, beacon at 2040 (Hollis, WV) |

272: MTN, Glen L. Martin State Airport, Baltimore MD, beacon at 2031 (Hollis, WV)

300: 3B, Brockville ON, beacon at 0055 (Osier, NY)

323: GTN, Wash. Nat'l. Airport DC, beacon at 2025 (Hollis, WV)

340: GFG, Leesburg VA, beacon at 1654 (Hollis, WV)

344: O, Ottawa Int'l. Airport ON, beacon at 0050 (Osier, NY)

353: FME, beacon at un-ID location, 1659 (Hollis, WV)

370: FID, beacon at un-ID location, 2010 (Hollis, WV)

374: No ID noted, WX for NY, New England, Harrisburg PA, Baltimore MD for period 0200-0315Z. Announced BC would continue till 0500 (Hollis, WV). This is possibly PJS on 375 kHz at Patrick Henry Airport, Newport News VA-- Ed.

383: IXX, beacon at un-ID location, 2001 (Hollis, WV); SH, Smiths Falls ON, beacon at 0047 (Osier, NY)

407: H, St. Hubert PQ, beacon at 0045 (Osier, NY)

414: 3V, Gatineau PQ, beacon at 0040 (Osier, NY)

471: Un-ID CW station in CW at 0043 w/beacon light status report for MA/RI, hurricane bulletin & notice to mariners about navigational aids, plus warnings of USN test firing.

2291: IDQ, Italian Navy, Rome, Italy at 0103 with CW call marker reading IDQ/2/3/5/6 (Tom Kneitel, NY)

2395: 72JL, Spanish Navy, at 0111 with CW callsign marker (Kneitel, NY)

2598: VCG, Riviere du Benard PQ, in USB w/marine WX at 0036 (Ross, Canada)

2670: NMM13, USCG, Cape Hatteras NC, USB at 0133 w/notices to mariners (Ross, Canada)

2806.5: CCS, Chilean Navy, Santiago, Chile sending VVV in CW at 0148 (Kneitel, NY)

2812: GYA, Royal Navy, London, England, w/callsign marker in CW at 0150 (Kneitel, NY)

3407: KJY74, "Miami Monitor," waking NOAA aircraft #42, USB at 0443. Aircraft was in the eye of hurricane Elena sending WX data (Ross, Canada)

4277: ZLBZ, Awassua, New Zealand in CW at 1133 w/callsign marker & QSX info (Osier, NY)

4283: ZSJ2, NAVCOMCEN, Silvermine Cape R., RSA in CW w/callsign marker at 2318 (Osier, NY)

4310: MTI, Royal Navy, Plymouth, England at 2318 w/CW callsign marker (Osier, NY)

4317: ZSC33, Capetown RSA w/CW marker at 2345 (Osier, NY)

4525: Y3S, Naven GDR w/time signals at 0041-- (Osier, NY)

5000: ZUO, Olifans Fontein RSA w/time signals at 0025 (Ross, Canada)

5090: EE/YL with 3/2F groups at 0003 (Osier, NY)

5110: Voice scrambler noted at 0112 (Osier, NY)

5307: "D" beacon in CW at 0044 (Kneitel, NY)

5308.3: "Z" beacon in CW at 0043 (Kneitel, NY)

5316: GG/YL with 3/2F groups at 0003 (Osier, NY)

5434: EAGLE 1 working DURAN in LSB w/"phased RY tests on frequency A4" at 1404 & again at 1712. "I've since heard EAGLE 1 many times on 5800 kHz USB working anti-smuggling station MARLIN & other similar units, not sure if it's the same EAGLE 1." (D. McEwan, NY)

5915.2: ZLZ20/22, Wellington (Himatangi), New Zealand in CW w/call marker at 0803 (Bledsoe, AK)

5918.5: 5L groups in CW at 0220, sent very slowly (Kneitel, NY)

6200: WJXG, M/V PFC JAMES ANDERSON JR., working COMMSTA Portsmouth in USB at 1328, asking for Telex info (Daryll Symington, OH)

6423.5: HPP, Panama City, Panama, in CW at 0850 w/call tape (Ross, Canada)

6460: FUM, French Navy, Papeete, Tahiti in CW w/call tape at 1211 (Osier, NY)

6493.5: URB2/RWWM, Klaipada, Lithuanian SSR in CW calling "VL1" (Australian allocation but probably a tactical ID) at 0501 (Bledsoe, AK)

6715: SAM-31682, US mil aircraft in LSB w/phone patch to SAM Command Post at Andrews AFB at 1725 (Symington, OH)

8440.8: UAT, Moscow, USSR in CW w/call tape at 1807 (Bledsoe, AK)

8448.8: A9M, Bahrain, in CW w/call tape at 1456 (Bledsoe, AK)

8463.9: 5BA, Nicosia, Cyprus, in CW w/call tape at 1811 (Bledsoe, AK)

8473: A7D, Qatar, in CW w/call tape at 1454 (Bledsoe, AK)

8489: CUL7, Lisbon, Portugal, in CW w/call tape at 2036 (Osier, NY)

8513.8: X5Q/4/7, Guangzhou PRC, in CW w/call tape at 1818 (Bledsoe, AK)

8520.1: UKW3, Korsakov Sakhalinsk USSR in CW working UPJN (Soviet ship) at 0503. UKW3 is on Sakhalin Island, famous during KAL-007 airliner incident (Bledsoe, AK)

8523.5: JOR, Nagasaki, Japan, in CW w/call tape at 1246 (Bledsoe, AK)

8540.9: PKI, Jakarta, Indonesia, in CW w/CW call tape at 1701 (Bledsoe, AK)

8547.8: JFA, Matsudo, Japan, in CW w/call tape at 1248 (Bledsoe, AK)

8571.5: 9VG43, Singapore in CW w/call tape at 1513 (Bledsoe, AK)

8573.5: HSA2, Bangkok, Thailand, in CW w/traffic list at 1446 (Bledsoe, AK)

8576.9: HLO, Seoul, ROK, in CW w/call tape at 1446 (Bledsoe, AK)

8604.4: DZJ, Bulacan, Philippines, in CW w/call tape at 1252 (Bledsoe, AK)

8630.3: 9MB2, Penang, Malaysia, in CW w/call tape at 1627 (Bledsoe, AK)

8633.6: VTG3, Bombay, India, in CW w/call tape at 1501 (Bledsoe, AK)

8635.5: HLW, Seoul, ROK, in CW w/ship traffic at 1255 (Bledsoe, AK)

8661.8: JH, Kure, Japan, in CW w/call tape at 1259 (Bledsoe, AK)

8694: XSZ, Darien PRC, in CW w/call tape at 0725 (Bledsoe, AK)

8710.4: UAH, Tallin, Estonian SSR, in CW w/call tape at 1403 (Bledsoe, AK)

8918: J3R, famed mystery station that's been operating for 20+ years. Sending VVV in CW at 2120, s/off 2125 (Kneitel, NY)

8968: Aircraft #4994 working LOCKHEED FLIGHT in USB at 1945. Aircraft advises "over the reservoir, doing ground proximity work, will be back in later." (McEwan, NY)

8991: FUV, Djibouti Naval R., Djibouti w/CW call tape at 2328 (Osier, NY)

8993: Clipper 456, PanAm aircraft working MacDill AFB in USB at 1606, enroute Mexico City to Dulles. Earthquake relief mission? (Symington, OH)

8993: MAC-60192 in USB working MacDill at 2053 flying in earthquake relief from Dyess AFB to Mexico City (Symington, OH)

9120: GG/YL with 3/2L groups in USB at 2106 (Kneitel, NY). Noted at 2106 as GG/YL with 3/2F groups (Osier, NY)

9220: Un-ID stations exchanging 3L groups in USB at 1524, authentications followed (McEwan)

9348: VOA feeder in LSB w/English news, at 1320. Location? (Kneitel, NY)

11200: MVB, RAF West Drayton, England, with USB VOLMET BC at 1856 (Kneitel, NY)

11249: SAM-31681 working Andrews AFB in LSB at 1915; 'phone patch in progress. Aircraft departed JFK at 1905 w/Soviet delegation enroute Andrews. This was on day that Soviet Premier Cernenko died. This was apparently the USAF flight that took delegation to DC for special flight to USSR (McEwan, NY)

11591.3: M4Z, location unknown, in CW at 0115 w/crypto traffic (5L groups) in mil format "GRA DE M4Z NR 14 170100Z OCT 85 KEY ALFA DELTA TANGO." Ended w/"WHISKEY ALFA LIMA DELTA TANGO BT AR" (Kneitel, NY)

11560.6: "UA" Soviet MCW jamming signal at 1923 w/ident every 25 seconds (Bledsoe)

11705: "KB" Soviet MCW jamming signal at 1925 w/ident every 25 seconds (Bledsoe, AK)

12085: "GR" Soviet MCW jammer at 1929 w/ID every 25 seconds (Bledsoe, AK)

12329: OVG12, Frederikshavn, Denmark (Navy) at 1957 w/CW call marker (Kneitel, NY)

12547: PJC, Curacao, in CW w/call marker at 2110 (Osier, NY)

12667.8: JCX, Naha, Japan, in CW w/call tape at 0713 (Bledsoe, AK)

12673: CLA33, Havana, Cuba, in CW w/call tape at 2328 (Osier, NY)

12727.3: HLJ, Seoul, ROK, in CW w/call tape at 0506 (Bledsoe, AK)

12750: CWA, Cerrito, Uruguay, in CW w/call tape & QSX info at 2344 (Osier, NY)

12765.9: UAI3, Nakhodka USSR in CW at 2309 when transmission ending (Bledsoe, AK)

12784.4: XSX, Keelung, Rep. of China, in CW w/call tape at 0545 (Bledsoe, AK)

12785: UPW2, Liepaja, Latvian SSR, in CW w/call tape at 0547 (Bledsoe, AK)

12796.7: UDK2, Murmansk USSR in CW calling 4LS at 1532 (Bledsoe, AK)

12829: XFM, Manzanillo, Mexico, in CW w/call tape at 2349 (Osier, NY)

12854.2: UKA, Vladivostok USSR in CW w/call

tape at 0300 (Bledsoe, AK)

12864.1: XSW, Kaohsiung, Rep. of China, in CW with call tape at 1756 (Bledsoe, AK)

12871.3: XSG7, Shanghai PRC, in CW w/call tape at 0517 (Bledsoe, AK)

12878.1: JCU, Choshi, Japan in CW w/call tape at 0516 (Bledsoe, AK)

12939.1: SPE41, Szczecin, Poland in CW w/call tape at 0536 (Bledsoe, AK)

12943: CUL7, Lisbon, Portugal, in CW w/call tape & QSX info at 2137 (Osier, NY)

12947.9: JJJ, Tokyo, Japan in CW w/"FB3" marker at 1801 (Bledsoe, AK)

12968.5: XSV, Tianjin PRC in CW w/call tape at 0134 (Bledsoe, AK)

13015: URD, Leningrad USSR in CW at 1209 w/marker "DE URD QSX 6/8/12/16/22" (Kneitel)

13020.2: VPS, Hong Kong in CW w/call tape at 0426 (Bledsoe, AK)

13031.2: VRN35/60, Hong Kong in CW w/call tape at 0715 (Bledsoe, AK)

13035.1: UBA2/UJFH, Petropavlovsk USSR in CW w/call tape at 0401 (Bledsoe, AK)

13039.9: UFN, Novorossiysk USSR in CW w/call tape at 0553 (Bledsoe, AK)

13054: JDC, Choshi, Japan in CW w/call tape at 0509 (Bledsoe, AK)

13055: UJQ7, Kiev, Ukraine, in CW w/ship traffic at 0555 (Bledsoe, AK)

13089: UFN, Novorossiysk, USSR in CW w/call tape at 1219. UAT, Moscow, w/CW call tape at 1635 (Kneitel, NY)

13099.4: UXN, Arkhangelsk USSR in CW w/call tape at 1438 (Bledsoe, AK)

13204: BANGER CONTROL working other units in USB at 1929, war games traffic. "A taped female voice with statement 'Depart your orbit; this will be your only warning. Lay down your arms. Your family needs you at home. This is not your homeland you're fighting for, give it up while you can.' How's that for realistic exercises?" (McEwan, NY)

13247: BAC9, possibly Beijing PRC "DE BPA URUMQI PRC" in CW w/callup at 1231 (Schimmel, VA-- that's me!)

13525: 5L groups in CW at 2005 (Kneitel, NY)

13826: NNN0NRO, new USN MARS station in Rota, Spain, USB w/phone patch to NNN0NIM at 2100 (Symington, OH)

15015: AIREVAC 38083, US mil aircraft in USB at 1426 working Ascension w/phone patch to Andrews AFB AIREVAC Ops (Symington, OH)

16942.9: YUR, Rijeka, Yugoslavia, in CW at 1547 w/marker "VVV DE YUR QSX 16 MHZ CH/6/12 K" (Kneitel, NY)

17118.2: HLG, Seoul, ROK in CW w/call tape at 0148 (Bledsoe, AK)

17189: D3E71, Luanda, Angola, CW call marker at 1917 (Kneitel, NY)

27406: "Unit 212 Suzuki Base Station," Santo Domingo, Dominican Republic, USB at 0011 to 0033. An OM announcing, "CB'ers all over the East Coast, I'm using a 4-element beam 50 feet up and 125 watts; people in Ohio, West Virginia, Louisiana, Tennessee, even New York." (Osier, NY)

PC

THE AMATEUR RADIO VERTICAL ANTENNA HANDBOOK

CAPT. PAUL H. LEE, USN(RET), N6PL

Capt. Paul H. Lee's *Vertical Antenna Handbook* became a classic in its first printing. Out of print for several years, this Second Edition has been brought out in response to your demand and the needs of the service. Among the topics covered are vertical antenna theory, design, installation, and construction. Specific information is given on vertical arrays, feeding and matching, short verticals, ground effects, and multiband and single-band verticals, plus there is a section that answers many of the most commonly asked questions about vertical antennas for the amateur. The Second Edition features an addendum on antenna design for 160 meters, the band that finally is coming into its own.

Order your copy now.



Popular Communications 76 N. Broadway, Hicksville, NY 11801

Please rush me my copy of the 2nd Edition of *The Vertical Antenna Handbook*:

\$9.95 for the book plus \$2 for shipping & handling.

Name _____
Address _____
City _____ State _____ Zip _____

Mastercard

VISA

My account number is:

| | | | |
|--|--|--|--|
| | | | |
|--|--|--|--|



LISTENING POST

GERRY L. DEXTER

WHAT'S HAPPENING: INTERNATIONAL SHORTWAVE BROADCASTING BANDS

We are deep into the shortwave broadcast DX'ing season now and despite what seems to be as many bad days on the bands as good ones, there are still any number of good catches making it to headphones around the country. You may think your antenna system has collapsed, but the odds are you are simply experiencing one of the frequent downturns in conditions. For those who have patience and know how to dig, there are good things to be found.

Elusive Radio NYAB in Bhutan is reportedly planning to come in from the cold. Now a thimble-sized 200 watts with a very limited broadcast schedule, NYAB has purchased a five kilowatt Harris transmitter which was expected to be on the air by the end of 1985. That 25 fold power increase is reportedly just the first step. According to a report in the bulletin of the Danish Shortwave Club International, the next step is a 50 kilowatt transmitter to be operational by the end of 1987. Radio NYAB currently operates in local languages from 1100-1400 (with English the last half hour) on highly variable 3.395 on Wednesdays and Fridays only, and on Sundays from 0700-0900 on widely variable 7.040. At least we can now allow ourselves to hope!

There's still no sign of the new high power transmitters in Yugoslavia, although that government has been registering frequencies for some time now. Work proceeds but it may be 1987 before these are on the air. Meantime, Radio Yugoslavia is currently heard here in the late afternoons on 6.100 and 9.620, with some English.

Deutsche Welle has again been forced to abandon work at its new Sri Lanka relay station after another raid by Tamil terrorists. The station was scheduled to begin operations at full power on March 2, but some reports say the whole idea of a relay here may be dropped. DW also has plans to add an hour of English to North America.

Radio Earth, the popular program service currently carried over KCBI on Sundays, has taken a major step toward becoming a full-fledged station. They have purchased a 25 kilowatt transmitter which is currently being prepared for service, probably from the island of Curacao in the Netherlands Antilles. The transmitter is equipped for single sideband operation (at double the power), so Radio Earth could switch to SSB if that mode ever develops real usage by broadcasters. The station is also considering eventual stereo operation on shortwave. Projected sign on date from Curacao is June 1.

You probably saw the news story about the Voice of Hope bombing in Lebanon in which six persons were killed. The station was able to resume operations from its transmitter site shortly after the attack. High Adventure Ministries, which owns the station,

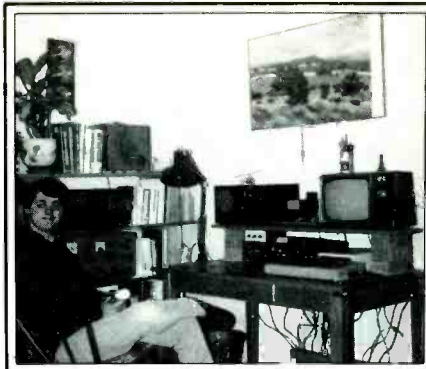

Steve and Jeanette Smith of San Francisco get good Asian and tropical band reception.

is seeking \$475,000 to rebuild. A frequency move from 6.215 to 6.280 was to have taken place late in 1985.

In the meantime, High Adventure's U.S. station, KVOH at Rancho Simi, California has this projected schedule for the spring: 0600-0800 on 6.005, 0300-0600 on 9.852.5, 0100-0300 on 11.930, 1400-1700 on 11.940, 2200-0100 on 15.250, and 1700-2200 on 17.775. The station still isn't on the air as of this writing, but you may want to keep a check on the above times and frequencies. Initially, most of the programs will be in English.

Radio Venceremos has company! A September Associated Press story datelined San Salvador reports on a fake Radio Venceremos said to be operating occasionally near the frequencies of the real one. The fake pretends to be the voice of the FMLN, but apparently doesn't do a very good job at it. When on, it usually operates during the same hours as the genuine article. However, we haven't seen any reports of the fake being heard here. Maybe it's hard for non-Spanish speakers to tell the difference.

Publicity Chairman Dr. Harold Cones of the Old Dominion DX'ers reminds us about this club that serves listeners in southwestern Virginia and Northeastern North Carolina. The club puts out a monthly newsletter, holds regular meetings, and has a new awards program. If you live in the area, the

club would welcome you as a member. For more information, send an SASE to ODDX Club Headquarters, 625 Charlecote Drive, Virginia Beach, VA 23464.

This reminds us to mention that the Chicago Area DX Club has come home to Chicago. It is no longer headquartered in Milwaukee, Wisconsin. CADX also publishes a monthly bulletin, holds several banquets, picnics and other outings each year, and maintains a telephone alert DX tip system. Dues are \$12 per year and the club is open to anyone with a radio monitoring interest who lives within 150 miles of the windy city. The new headquarters are at 6524 South Sacramento, Chicago, IL 60629.

We had the pleasure of attending a recent meeting of the Minnesota DX Club in Minneapolis and enjoyed meeting the some two dozen members present. MDXC is another very active group. If you live in Minnesota and would like more information, send a self-addressed, stamped envelope to MDXC, 5212 Drew Avenue South, Minneapolis, MN 55410.

How would you like to get a QSL from Radio Botswana? To introduce our newest book, *Secrets Of Successful QSL'ing*, we've agreed to draw the name of one listener and go to work trying to verify Radio Botswana for that person. To qualify, just send your name and address to: RR4 Box 110, Lake Geneva, WI 53147. The deadline is March 30, 1986. We'll put forth our best effort to secure a Radio Botswana QSL.

The book, *Secrets Of Successful QSL'ing*, covers everything you need to know about reception report writing and QSL collecting, including basics, follow-ups, prepared cards, tentatives, the post office, and a host of more specialized techniques. Whether you are a newcomer to QSL'ing or have 200 countries verified, we think it'll help improve your returns. The book costs \$9.95 plus \$1 shipping and handling, (\$2 foreign) in U.S. funds. It's available from Tiare Publications, P.O. Box 493, Lake Geneva, WI 53147.

Mail Call

Every month it seems we get at least one letter from a former shortwave listener now returning to the fold. Bob Wilcox of LaGrange, Illinois fills the bill this time. Bob was active in 1967-68 and now has returned, armed with a Toshiba RP-F11. He hopes to add a second receiver shortly. Welcome back, Bob, and we look forward to having your reports.

Ejaz U. Imami of Skokie, Illinois is originally from Pakistan and was quite an avid listener there. But here, he says the long hours at his job and the "fast pace" of life have kept him away from the radio until re-

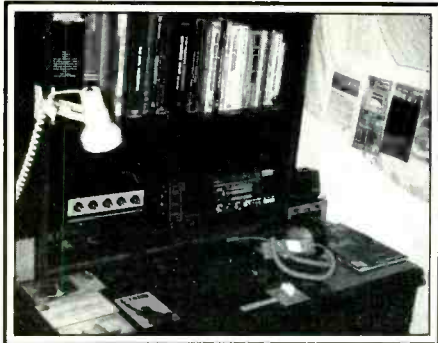

Alan Marhofke of Waukesha, Wisconsin does his listening at this neat set-up.

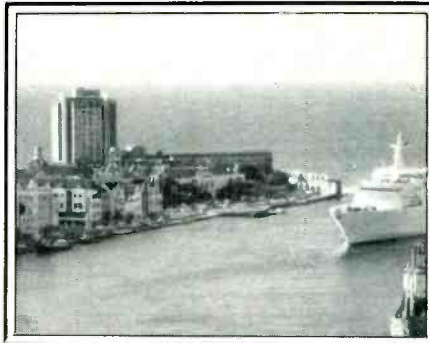

Curacao, where Radio Earth is expected to be later this year.

cently. Now he is listening again, with a particular interest in such stations as All India Radio, Radio Pakistan, and the SLBC in Sri Lanka. None of these are received very well in the midwest, Ejaz—try Radio Pakistan at 1330-1615 on 11.675, 15.595, or 17.660. You can also try 11.620 for AIR from 1845-2230 or 15.335 between 1300-1500.

Stuart Lyster would like to hear from listeners who live in western Canada or the pacific northwest. You can write to him at Box 211, Keremeos, BC VOX 1N0.

Stephen C. Behrendt of Lincoln, Nebraska checks in with information from a letter from Radio Zealand. The domestic service on shortwave continues, pending a report by a Royal Commission, which is looking into every aspect of radio and television there. Results are expected in about 18 months, but the letter writer implied it might be longer than that.

James E. Morgan in Bangor, Maine says the 3 and 4 MHz bands are really hopping in his area and that he's picking up all sorts of stations, most in languages he can't understand. Sixty and 90 meters is where most of the real DX hides, and you're not alone with the language problem. But DX is DX no matter what tongue it may speak. It can be hard work to ID the tropical band stations, but the challenge is a large part of the fun.

Patrick M. Griffith of Denver, Colorado thinks it would be useful to list how long it takes stations to reply with QSLs. He notes some of his response times, such as 150 days from Radio Jamahiriyah, 34 days from Radio Tahiti, 41 from Beijing, 88 for the Voice of Turkey. The trouble is, Pat, that response times can vary widely, even for the same station. We used the Voice of Greece as an example in our book. Reply times ranged from 30-40 days to over a year!

DX'ing and shortwave listening are often described as lonely, solitary hobbies. Not so at the Smith household in San Francisco, where both wife Jeanette and husband Steve are frequently at the dials of their ICOM R71A and assorted other receivers. All they need are two chairs at the table instead of one. See their photos, featured this month.

We'll look for your letter or log report next month. Comments, questions, news, schedules, clippings, QSL copies (or spare originals you don't want returned) are always welcome. Log reports should be by



Here's a recent QSL card from Radio Prague, sent by Eric Gardner in Maryland.

country, with your last name and state abbreviation on each one. And leave us some space between each so they can be cut for sorting.

Listening Reports

Here's what's on. All times are GMT.

AFGHANISTAN - R. Afghanistan 11.835 at 1230 s/on in unknown language w/flute interval signal, ID (Hickerson, AR).

ALBANIA - R. Tirana, 7.065 at 0000 w/news about Albania & editorials (Gardner, MD).

R. Gjrokaster home service on 5.020 from 0450 to 0459 in Albanian, music pgm (Fravel, WV).

ALGERIA - R. Algiers on 9.609 in English at 2015, news, Arabic music, woman announcer (Hunt, NC); 9.640 at 2250 in Arabic, Spanish at 2300 (Linonis, PA); 15.215 at 2005 w/news in English to 2015, ID, 15 min. of music, s/off (Mayo, ME); 15.220 at 2000 in English w/news (Lukas, NY); 17.745 from 2000 s/on in English w/news, commentary. Weak/fading (Behrendt, NE).

ANGOLA - R. Nacional, Luanda on 4.820 from 0507-0524 fadeout in vernaculars & English (Fravel, WV).

ANTIGUA - Deutsche Welle Relay on 6.040 at 0200. Extremely strong to N. America (Linonis, PA).

BBC Relay at 0430 in English on 9.510 (Griffith, CO).

ARGENTINA - RAE w/Argentine music at 0135, talk about remote areas of Argentina at 0140 on 9.690 (Hunt, NC).

Noted on 11.710 at 0704-0710 news in Spanish (Johnson, NE); 15.345 at 1214 w/news-music (Pastrick, PA).

ARMENIAN SSR - R. Yerevan on 15.180 at 0350 w/news in English (Griffith, CO).

ASCENSION ISLAND - BBC Relay 9.765 in Spanish from 0300-0400 (Chinakos, WA); 0015 in Spanish (Lukas, NY); 1800 w/world news in English on 15.400 (Moran, IL).

AUSTRALIA - R. Australia, 5.995, 6.045, 6.060, 9.580, 9.710 at 1200 w/news (Northrup, WI); 6.060 good at 1130-1230 (Lupi, FL); 1320 w/US pops (Hunt, NC); 1215 w/talk on Australian minority groups (Pastrick, PA); 0800 w/English news (Imami, IL); 9.740 at 1100, variety of music, sports at 1130 (Probst, AL); 15.320 0615-0700 s/off -w/"Radio Bloopers" (Harnish, IN); 0530 w/"Jazz Australia" (Mayo, NE).

VLRL/VLH ABC Domestic Service at 0905 on 9.680 (Griffith, CO).

AUSTRIA - R. Austria Int'l. on 6.000 at 0145 w/classical guitar (Hunt, NC); 11.660 at 2243 (Lukas, WY).

BANGLADESH - R. Bangladesh on 9.640 at 1400. 5-min. interval signal before s/on using violins w/periodic English ID's (Batman, LA); 15.525 at 1250 w/music, comments by woman announcer, poor signal (Hunt, NC).

BELGIUM - BRT on 5.910 at 0047 in English. "P.O. Box 26" at 0100; off 0124 (Mayo, ME); 0100 w/sports (Hunt, NC); 15.570 at 0115 with "Belgium Today" (Hunt, NC).

RTBF in French at 1740 on 17.675 w/pop music (Moran, IL).

BELIZE - R. Belize, 3.285 at 0543-0605 s/off. English w/Caribbean music, ID "Radio One in Central America," off w/anthem (Johnson, NE); Q&A program at 0230 (Behrendt, NE); 0120 w/world news (Hunt, NC); 2330 English under noise (Moran, IL).

BENIN - RTB on 4.870 in French, man announcer (Lingenfield, PA).

BOTSWANA - R. Botswana 3.356 at 0417 w/church service in Setswana on Sunday morning (Tarte, MI); 7.255 at 0355 w/American music, good signal (Marhofke, WI); 0500 in African language beneath V. of Nigeria (Batman, LA).

BRAZIL - R. Nacional, Manaus, 4.845 at 0256-0303 s/off. Latin music & Portuguese (Johnson, NE).

R. Cultura, Sao Paulo, 6.165 at 0800, man in Portuguese, weak sigs (Moran, IL).

R. Rio Mar, Manaus (9.695?-- Ed.) 0959-1021 in Portuguese w/heavy fading (Fravel, WV).

Radiobras, 11.745 at 0210 in English w/report on Brazilian rose exports (Gardner, MD); 0220 w/Latin music (Pastrick, PA); ID & address at 0248 (Leach, NE); 0200-0250 in English (Behrendt, NE); report on 400 AIDS cases in Brazil (Hunt, NC).

R. Nacional Amazonia, 11.780 at 2155, 2 male announcers in Spanish, rapid talking (Moran, IL); Brazilian music at 0150 (Hunt, NC); 1043 in Portuguese (McDanough, PA).

R. Nacional, 15.105 at 1850, male announcer, dance music (Moran, IL).

R. Surinam Int'l., via Radiobras, 17.755 at 1755 in English/Dutch, music/talk (Pastrick, PA).

BULGARIA - R. Sofia, in English 2130-2200 on 6.070, 7.215, 7.115; at 2230-2330 on 6.070, 11.720; 0300 on 7.115 from 3 November (Batman, LA); 7.205 at 0326 w/listener mail (Aldrich, IA); 6.160 at 2130 in English w/news, also on 6.070 this hour (Lukas, NY); 9.700 at 2255, Bulgarian music (Hunt, NC); 1220 segment included SWL program (Northrup, WI); 15.310 at 2019 in English "mosaic of news from Bulgaria" (Mayo, ME).

BURKINA FASO - RTB on 4.815 at 0610 w/pop African music, news in French 0630, variety program 0640 (Behrendt, NE); 2318 in French w/music but mostly talk (Leach, NE).

CAMEROON - R. Bafoussam, 4.000 at 0449 in local language, possibly religious BC (Fravel, WV); IS/ID/s-on in French 0500 (Hickerson, AR).

R. Douala, 4.795 at 0504 in French w/music program (Fravel, WV).

Radiodiffusion Nationale, Yaounde, 4.850 w/ID at 2310 (Morgan, ME).

CANADA - RCI on 6.195 w/CBC Northern Quebec Service at 0125, bank accounts being investigated by government (Hunt, NC); In French on 11.710 at 2230 (Lukas, NY); 11.945 RCI in English at 1950 w/SWL program (Schute, FL); 15.260 at 1815 in English (Moran, IL).

CFRX, Toronto, 6.070 at 1250, 1960's pop tunes, DJ chatter (Hunt, NC); old pops at 0240 (Hunt, NC).

CENTRAL AFRICAN REPUBLIC - R. Centrafrique, Bangui, 5.035 from 0501-0508 fadeout w/music program in French (Fravel, WV).

CHAD - Radiodiffusion Nationale Tchadienne,

N'djamena, 4.904 at 0502 in unknown language (Shute, FL) Probably French-- Ed.
R. Moundou, 5.288 from 0504 in French, heavy static & ute QRM (Lingenfield, PA).

CHILE - R. Nacional, 15.140 at 2306 w/soccer match (Leach, NE); 1845 rapid fire talk in Spanish (Moran, IL).

R. Agricultura, 9.630 at 0100 in Spanish w/pops, usually covered by Madrid (Batman, LA).

CHINA - R. Beijing, 9.535 at 1209 w/news (Pastrick, PA); 11.500 at 2135 strong in Chinese w/woman & English ID (Hickerson, AR); English to N. America 1100-1200 on 11.860, 1200-1300 on 11.860/11.650 & test frequency 9.535, also heard testing to N. America on 11.970 0000-0100 (Batman, LA); 1255 on 11.860 in English (Lingenfield, PA); 15.385 at 0011 to 0500 s/off (Mayo, ME); 0000 announcing that 15.385/15.520 being dropped in favor of 9.820/11.685 (Harnish, IN); 15.520 at 0400 in English w/letterbox (Gardner, MD).

Fujian Front 1, 7.025 in Chinese at 1052, tentative (Lingenfield, PA).

CLANDESTINES - A Voz de Verdade, 4.950 at 0308-0345 in Portuguese w/ID's, announcements, mentions of Angola. Pop music/news 0334 w/tones, theme music 0338, carrier on to s/off at 0345 (Paszkiwicz, WI).

R. Monimbo, 6.230 at 0300 in Spanish w/anti-Sandinista commentary (Batman, LA).

R. Venceremos, 6.565 at 0305 in Spanish, anti-Duarte talks, lively music. Also 6.560 next night at 0328 & 6.555 following night at 0315 (Paszkiwicz, WI).

COLOMBIA - Caracol Nevía/Colosal on 4.945 at 0626 w/Latin music (Johnson, NE); 0715-0730 in Spanish, call-in show & pop music (Moran, IL); 0511 w/talk about communications & Mexican earthquake (little did they realize how important communications would become during Colombian volcano eruption shortly thereafter) (Shute, FL).

E. Nueva Mundo, Bogota, 4.755 in Spanish at 0457 (Lingenfield, PA).

R. Macarena, 5.975 at 1041 in Spanish w/lots of music (Lingenfield, PA).

R. Sutatenza, 5.095 at 0330-0430 news, music, theater notices & ID's for "Radio Nacional de Educacion" (Behrendt, NE); 2300 w/very lively announcer, plenty of music (Linonis, PA).

COSTA RICA - R. Columbia, 4.850 at 0500, strong in Spanish w/ID, jingles, music (Harnish, IN); 0604 w/Latin music, strong (Johnson, NE).

R. Relej, 4.832 at 0700-0730 in Spanish, pop music, frequent ID's (Moran, IL).

R. Casino, 5.955 at 0540 in Spanish (Lingenfield, PA); 5.954 barely audible at 0555 in English, s/off at 0600 (Salmi, MA).

Faro del Caribe, 5.055 at 0328 w/English religious program, ID, into Spanish 0400, TWR-Swaziland in background 0356-0400 (Johnson, NE).

CUBA - R. Havana Cuba 6.100 at 0115 w/maillag in English (Lukas, NY); Announcement that station employees were staging a 10-minute work stoppage in support of protests over the national dept, 0435-0445 w/frequent announcements, political music & interval signal (Griffith, CO); 9.740 at 0500 in English (Lukas, NY); 12.100 at 0024 w/contest offering all-expense paid trip to Cuba (Shute, FL); 15.230, 15.300 at 1817 in Spanish. Strong sigs but poor audio (Moran, IL); 15.300 at 2128 w/"Eyewitness Africa" (Pastrick, PA).

CYPRUS - BBC Limassol Relay, 11.760 1104-1115 in English w/world service news (Fravel, WV).

CZECHOSLOVAKIA - R. Prague w/English to N. America at 0100 & 0300 on 5.930, 7.345, 9.540, 9.740 usually covered by Havana (Batman, LA).

DENMARK - R. Denmark, 15.165 from 1530-1353 s/off in N. American service, English/Danish ID (Fravel, WV).

DJIBOUTI - RTV Djibouti, 4.782 at 2300-2330 presumed, in French w/male & female announcers, story or play being read, local music, mentions of Djibouti. Tentative ID 2330 (Tarte, MI).

DOMINICAN REPUBLIC - R. Santiago, 9.778 at 0317 in Spanish, ID, soda & bank ads, heterodyne, fadeout 0337 (Paszkiwicz, WI).

R. Clarin, 11.700 at 0225 w/Latin music, distorted audio, man w/Spanish ID (Hunt, NC).

EAST GERMANY - R. Berlin Int'l., 6.125 at 2145 in English (Hunt, NC); 15.100 at 1850 in English, classical music (Moran, IL); 15.255 at 1415 to SE Asia, RBI DX Club of 1436 (Mayo, ME); opinion poll at 1445 (Salmi, MA); 6.070, 6.125, 6.165 at 2215 (Batman, LA).

ECUADOR - HCJB in Spanish on 3.220 at 0410 (Salmi, MA); 0000 w/music, Spanish (Behrendt, NE); to 0500 s/off (Johnson, NE). Note that 3.220 is used primarily for the Quechua language-- Ed.

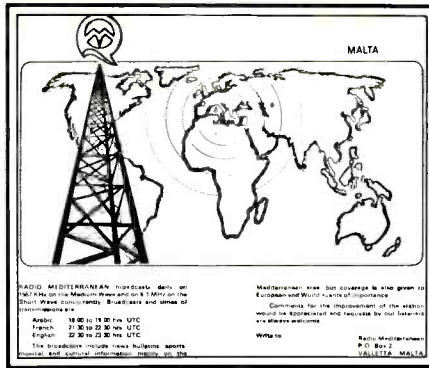

Billy Hunt of North Carolina got this QSL from Radio Mediterranean in Malta.

6.210 at 08-5-0820 in English (Moran, IL); 0734 in English w/"Happiness Is" (Imami, IL); 9.655 at 0740 in English (Lukas, NY); 9.745 at 0430 w/call-in show (McDonough, PA); 9.870 w/DX Party Line at 0630 (Rials, LA); 1216 on 11.740 (Northrup, WI); 15.115 w/news & time pips at 1428 (Shute, FL); 15.172, slightly off-frequency at 0130 (Lukas, NY).

HIZIOA time station, 7.600 at 0300 w/time checks in Spanish (Rials, LA); 0020 and 0625 (Mayo, ME).

R. Jesus del Gran Poder, 5.050 in Spanish at 1054 w/religious program (Lingenfield, PA).

E. Atalaya, 4.782 at 0448 to s/off 0502 in Spanish w/variety of music (Fravel, WV).

R. Quito, 4.920 at 0214 in Spanish (Lingenfield, PA).

EGYPT - R. Caro 9.475 at 0219 in English w/news, requests for letters, political commentary, "Life in Egypt" (Mayo, ME); 0215 on 9.675 w/world news (Leach, NE); 15.210 in Arabic w/ID 1831 (Moran, IL); 15.335 at 2140 Arabic music (Aldrich, IA).

ENGLAND - BBC on 3.975 at 0430 in un-ID language (McDonough, PA); 3.950 w/world news & "24 Hours" from 0503 (Fravel, WV); 1217 on 5.965 w/news about Cyprus (Northrup, WI).

EQUATORIAL GUINEA - R. Nacional, Bata, 4.925 at 0510 w/African music, good signal (Shute, FL).

FALKLAND ISLANDS - FIBS, 3.958 at 2030 w/agriculture prices, discussing golf (Hunt, NC) Pretty odd time-- Ed.

FINLAND - R. Finland Int'l., 15.400 at 1300 in English, about vacationing in Finland (Hunt, NC).

FRANCE - R. France Int'l. 3.965 at 0528 in French w/music program, fair w/Ham QRM (Fravel, WV); 11.805 at 2015 in French (Lukas, NY); "Paris Calling Africa" 17.620 at 1600-1650, news/music/maillag (Behrendt, NE); Parallel w/11.705 but no copy in LA. Also transmission direct from France rather than Guiana relay 0300-0400 on 6.175 audible beneath BBC in both French/English (Batman, LA).

FRENCH GUIANA - RFI Relay, Montsinery, 9.800 w/news in English at 0445 (Griffith, CO); 0415 & 0445 (Mayo, ME); 11.995 at 0200 music & talk in Portuguese (Hunt, NC); 17.860 at 1620 in French (Moran, IL).

RFO Cayenne, tentative in French on 5.055 at 0200, various music types, talk (Linonis, PA); 0944 in French (Fravel, WV); 0900 w/pop music, news 0930 (Behrendt, NE).

GABON - Africa #1, 4.810 at 0514 w/talk, music (Leach, NE); 0523 w/music & talk in French (McDonough, PA); Very clear 0500-0600, also 2200-2300 (Linonis, PA); 15.200 at 1645 in French/English (Lukas, NY); ID by woman at 1600 in French, African music, talks in French (Miller, GA).

GHANA - Ghana BC Corp., 3.366 at 2244 w/talk on USSR relations. Different program than on 4.975 but // on Sunday evening at 2250 (Tarte, MI); 0541 w/music, English news, ID 0600 (Johnson, NE); Commercial service at 0550 in English, African pops (Salmi, MA); 49.15 at 0608 w/news & music, woman announcer (Leach, NE).

GREECE - V. of Greece on 7.395 at 0348 ending news in English (McDonough, PA); 0135 w/news, Greek singing (Hunt, NC).

GUATEMALA - La V. de Nahuala, 3.360 in Spanish at 0300 w/marimbas (Behrendt, NE).

R. Cultural, TGNA, 3.300 at 0225 in English w/ID (Morgan, ME); 0630 in Spanish (Salmi,

MA); 0220 in English w/religious programs (Hunt, NC).

GUINEA - Radiodiffusion Nationale Guinee, 4.910 at 0713 w/kalimba music (Tarte, MI); 2335 in Vernaculars, hi-life music (Hickerson, AR).

GUYANA - Guyana BC Corp., 5.950 at 0824 in English w/music, ID 0829 (Johnson, NE).

HUNGARY - R. Budapest 0400-0415 in English Wed. & Sat. (GMT) w/DX program on 6.025 (Batman, LA); 0100 w/news local events in Budapest (Hunt, NC).

HONDURAS - La V. Evangelica, HRVC, 4.820 in Spanish at 0300 w/religious music, Spanish (McDonough, PA).

3.2496 R. Luz y Vida, 0210 in Spanish w/religious programming (Hickerson, AR).

INDIA - All India R. regional at Gahwatentative on 4.775 at 1149 w/flute & vocal music in un-ID language (Tarte, MI).

IRAN - VOIRI, 9.022 at 1030 "From our studios in Tehran, the news from the Islamic Republic of Iran," schedules, news, music (Miller, GA); 2005 anti-US talk, revolutionary music (Hunt, NC).

IRAQ - R. Baghdad, 9.610 at 2030 w/English news. Heavy QRM (Hunt, NC).

ISRAEL - Kal Israel, 9.435 w/news at 2238 (Lyster, BC); 0100-0126 s/off w/news & features in English (Behrendt, NE); 7.410 at 2135 w/talk on Hebrew preschool in Moscow (Leach, NE); 2230 w/news (Gardner, MD); 11.605 at 2015 in English w/discussion (Hunt, NC). Current English to N. America is 2230-2300 on 5.880, 7.410, 9.435, 11.960; 0000, 0100 & 0200 on on 5.915, 7.410, 9.435; 0500-0515 on 7.410, 9.435 & 11.655 (Batman, LA).

ITALY - RAI on 11.800 at 1938 w/news in English (Johnson, NE); 9.575 at 0100 w/news in English (Griffith, CO).

IVORY COAST - Radiodiffusion Ivoirienne, 7.215 in French at 0620 (Salmi, MA); 0622 w/music both local & American soul. News at 0630 after xylophone IS (Johnson, NE).

JAPAN - R. Japan at 0016 on 15.300 w/English ID, frequency announcement. East coast beam (Shute, FL) Probably via Gabon-- Ed.; 17.755 at 2330 w/"Our Heritage," 2350 news, 2359 s/off (Mayo, ME); 2315 w/DX program (Miller, GA); English 1300-1400 9.505//9.605; 11.840 covered by Moscow at 1330 & 9.605 usually weak if audible at all but 9.505 is fairly strong after BBC-9.510 s/off at 1330 (Batman, LA).

KENYA - V. of Kenya in English on 9.635 at 0730, weak w/rapid flutter (Batman, LA).

KUWAIT - R. Kuwait, 11.675 at 2040 in English, happenings in Kuwait (Hunt, NC); 1800 s/on, western pop music (Behrendt, NC).

LIBYA - R. Jamahiriyah at 1815 in English, agricultural report & pop music through jamming (Gardner, MD); "Postbach" program at 1833 (Pastrick, PA); 1625 "Planning For Prosperity" (Hunt, NC); music, news in English 1830 (Lukas, NY); 1855 announcement for African service (Mayo, ME); 2204 "Change from Within" & "Story of the Libyan Revolution" (Aldrich, IA).

V. of The Mosses service, 7.245 at 0135 in Arabic (Hunt, NC); 15.235 at 1825 in Arabic (Moran, IL).

LIBERIA - ELWA at 2200 in English w/religious program, ID, anthem & off 2226 (Paszkiwicz, WI); 2155 w/ID on the hour (Salmi, MA); 2216 w/American-produced Bible programs (Tarte, MI).

VOA Monrovia Relay w/African service on 17.870 at 1615-1630 in English w/"Nightline Africa" //15.600 (Moran, IL).

LUXEMBOURG - R. Luxembourg, 6.090 at 2304-0050, rock, good signal (Lupi, FL).

MADAGASCAR - R. Netherlands Relay, 9.540 at 2020 in English (Lukas, NY); 17.575 at 1625 w/s-off, weak despite 300 kW (Moran, IL).

MALAYSIA - R. Malaysia, Kuching (Sorawak) on 4.835 at 1152 in Malayan w/eastern choral music (Tarte, MI).

MALI - Radiodiffusion Nationale du Mali, Bamako, 4.783 in French at 2320 w/African vocals to 0000 s/off (Behrendt, NE).

MALTA - R. Mediterranean, 6.110 at 2310 w/int'l. tennis scores, talk on UN, music (Hunt, NC).

MEXICO - R. Mexico Int'l., 9.705 at 0321 in Spanish. Names & phone numbers related to earthquake (Fravel, WV); 9.705//11.770 at 1910 w/ads & ID's (Hickerson, AR); 15430 w/news in Spanish 0000 (Leach, NE); 2300-0000 man in Spanish, brief classical music segments (Moran, IL).

XEWW La V. de la America Latina, 6.165 at 0630 w/ID in Spanish, opera (Chinakos, WA).

MOROCCO - VOA Relay, Tangiers, 15.245 at 1820, man in Arabic (Moran, IL); 9.540 in Spanish (Lukas, NY).

MOZAMBIQUE - R. Mozambique, 3.212 at 0350 w/hi-life, ID in Portuguese, IS 0400 (Hickerson, AR).

NAMIBIA - Southwest Africa BC Corp. at 0345 on 3.270//3.295 un-ID language, music. Weak (McDonough, PA); 0200 on 3.295 w/pop music in the all night service, brief ID on the hour (Behrendt, -NE); 0347 FM-type quiet music (Fravel, WV).

NETHERLANDS ANTILLES - R. Netherlands Bonaire Relay, 9.715 at 0530 w/"Media Network" (Rials, LA); 6.020 at 0200 English (Northrup, WI); 9.590 at 0235 w/world news, "Newline" (Hunt, NC).

TWR Bonaire 11.875 at 2145 sermon in English (Moran, IL), 11.815 at 1207 w/preaching (Northrup, WI); 1202 Bible history (Pastrick, PA).

NEW ZEALAND - R. New Zealand on 11.780 at 0507 w/news in Maori, then into English & "Roundabout" (Salmi, MA); 6.100 in English at 0700 w/ID, big band music (Morgan, ME); 15.150 at 0355 w/MOR music, nnews. Also at 0030 at 17.705 w/New Zealand news, agriculture features (Behrendt, NE).

NICARAGUA - V. of Nicaragua, 6.015, English at 0547 w/"Nicaragua Today" (Salmi, MA); 0517 (Lyster, BC).

NIGERIA - V. of Nigeria, 7.255 at 0450 w/IS & music/news/commentary (Leach, NE); 0457 in English (McDonough, PA); 0500 w/"Jamboree." Botswana audible underneath (Batman, LA).

R. Plateau, Jos, 5.965 w/news in English to 0615, followed by what sounded like church service in English (Batman, LA).

R. Nigeria, 4.990 in English at 2110 (Salmi, MA).

R. Kaduna, 4.770 from 0544 w/religious program. Heavy QRM from Mayak-4.765 (Fravel, WV).

NORTH KOREA - R. Pyongyang, English 9.750 //9.977 around 1100 (Batman, LA).

NORTHERN MARIANAS - KYOI Saipan, 15.405 at 2252 w/rock (Lingenfield, PA); ads in English & Japanese, T-shirt ad w/Hawaiian address (Mayo, ME).

NORWAY - R. Norway Int'l. 9.610 at 2158 w/English, Norwegian ads (Leach, NE); 11.855 at 2000 in English (Hunt, NC); 15.265 ID in English at 1825 (Lukas, NY); 15.305 at 1300 English news (Hunt, NC); 11.850 "Norway Today" at 1600 (Griffith, CO); 15.305 at 1300 in English (Lukas, NY).

OMAN - R. Oman on 11.890 at 1056 in Arabic. Heavy VOA QRM (Fravel, WV).

PAPUA NEW GUINEA - R. Manus, 3.3152 at 1110 in Pidgin, news time/ID, local music (Hickerson, AR); 1100 native vocals & Pidgin (Tarte, MI).

R. Madang, 3.260 at 1135, man in un-ID language (Tarte, MI).

R. West New Britain, Kimbe, 3.235 at 1135, pop music, R. Australia-sounding announcer, Pidgin (Tarte, MI).

NBC Port Moresby, 3.925 at 1146 animated talk in Pidgin. Also 4.890 at 1130 (Tarte, MI).

R. East New Britain, Rabaul, 3.385 at 1125, news in English/ID/rock (Tarte, MI).

R. Milne Bay, Alotau, 3.360 at 1058 in vernacular w/orchestral music (Tarte, MI).

R. North Solomons, Kista, 3.325 at 1100 in Pidgin w/native music (Tarte, MI).

PARAGUAY - R. Nacional in Spanish 0000-0300 on 9.735; frequent ID's, off w/anthem at 0300 (Linonis, PA).

PERU - R. Continente, San Martin, 8.925v at 0305 w/Latin music (Hickerson, AR).

R. Tarma, Tarma, 4.775 at 0441, music, talk, all Spanish (Leach, NE).

PHILIPPINES - VOA Relay, 15.210 at 1830, man w/sked & news in special English. Weak (Moran, IL).

PORTUGAL - R. Portugal 6.095 w/news, "Our Choice of Music" (Miller, GA); 0300-0330 6.090 (Lupi, FL); 9.740 at 0030-0100 English to N. America (Linonis, PA).

ROMANIA - R. Bucharest, 11.940 at 1320 in English. Classical music. Off 1325 (Hunt, NC).

RWANDA - R. Rwanda, 3.330 at 0410 in Swahili, hi-life, French ID. Deep fades (Hickerson, AR).

SAO TOME - R. Nacional, 8.805 at 2225 in Portuguese; ballads/announcements/jingles and vocals by choir. No ID so tentative. Another (possibly Brazil) at 2300 (Paskiewicz, WI).

SAUDI ARABIA - BSKSA 17.895 at 1730, Arabic & traditional music. Strong (Moran, IL).

SENEGAL - Radiodiffusion Television du Senegal, 4.890 at 0700 w/news in French, then alternating African music & 5-minute vernacular newscasts (Behrendt, NE).

SINGAPORE - BBC Far Eastern Relay 17.710 at 0015 in English, "Radio Newsteel," 0030 language lesson & off 0045 (Mayo, ME).

SOLOMON ISLANDS - SIBC 5.020 at 1150

WE'RE TRYING TO REACH YOU!

SUBSCRIBE NOW & SAVE! POPULAR COMMUNICATIONS

- \$42.00 for 36 Issues
SAVE \$28.40
- \$29.00 for 24 Issues
SAVE \$17.80
- \$16.00 for 12 Issues
SAVE \$7.40

May We Recommend . . .

A reception report to a privately owned (non-government operated) shortwave broadcaster has a better chance of earning you a QSL card if you enclose an International Reply Coupon (IRC) with your report. These are sold at most Post Offices.

ICOM R71-751-R7000* COMPUTER INTERFACE



MICROCOMPUTER ELECTRONICS CORPORATION NOW OFFERS THE M.E.C. 71α COMPUTER CONTROL INTERFACE THAT WILL CONTROL AND EXPAND THE CAPABILITY OF THE ICOM R71A.



MAIN MENU Control center for entire system. Showing: 24HR UTC time; radio freq, & mode; memory CH, freq, mode plus ID functions for your selection.

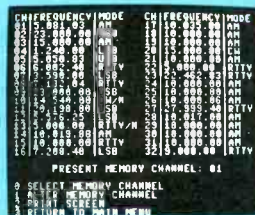

32 CH RADIO MEMORY Showing freq to 10 Hz, mode, filter w/n. Load/change any memory, mode, filter direct from keyboard and print command.



AUXILIARY MEMORY Showing page 1 of 47 pages each having 15 memories. Freq, mode, UTC time and room for your notes. Auto log feature allows instant logging of receiver freq, mode, time.

- **Easy to use.** No computer knowledge needed, automatic program loading. No disk or tape required (except for aux memory storage).
- **Menu driven** to aid user at each step.
- **No radio modification necessary** (ICOM EX309 — not supplied — required).
- **AUTO LOG** Allows logging of radio freq, mode and time by press of a key.
- **UNLIMITED STORAGE** via computer disk or tape (store 705 CH per disk side). Let your imagination run wild.
- **Software update.** As new software is developed MEC will make it available to owner subscribers.

- **HARD COPY** via computer printer of all memory channels.
- **KEYBOARD** memory loading.

INTRODUCTORY PRICE
\$199.95
(+ \$4.00 UPS)

EX309 required but not included. Price: \$39.00
Dealer Inquires invited.

EEB is the exclusive distributor for Micro-computer Electronics Corp's products worldwide.

EEB is an authorized ICOM dealer and service center.

GET ALL THE DETAILS. WRITE OR CALL EEB TODAY



- Prices & specs subject to change
- Shipping charges not included
- Returns subject to 20% restock charge
- Free catalog in USA; all others 3 IRC's

ORDER TOLL FREE 800-368-3270
Tech Info — VA orders 703-938-3350

ELECTRONIC EQUIPMENT BANK
516 Mill Street NE
Vienna, VA 22180 USA

CIRCLE 138 ON READER SERVICE CARD

w/pops, announcements in English & Pidgin (Tarte, MI).

SOUTH AFRICA - Radio RSA, 4.990 from 0352 in English to So. Central & E. Africa (Fravel, WV); 6.010 at 0159 w/news, mailbox, "Touring RSA" & "DX Corner" (Mayo, ME); 0216 talk of reforms (Pastrick, PA); 7.270 at 0418 w/"African Review" (Griffith, CO); 0340 w/discussion (Aldrich, IA); 9.615 "Africa Today" at 0235 (Griffith, CO); 11.780 at 0606 (Lyster, BC); 11.900 at 2140 to W. Africa & Europe. Sked at 2144 (Moran, IL).

Capital R., Transkei, 3.930 at 0327 in English w/pops, British sports scores, cigarette ads, time checks (Paszkiwicz, WI).

SOUTH KOREA - R. Korea, English from 1400-1500 on 9.750. Rarely good reception (Batman, LA); 15.575 to N. America at 0200 (Linonis, PA).

SPAIN - Spanish Foreign R., 9.630, English at 0500, talks about Spain (Rials, LA); 11.690 in English at 1842 & at end of news. RTTY QRM (Shute, FL); 11.880 at 0100 w/English news, sports, press review (Mayo, NE); 15.375 at 1805 in Spanish (Moran, IL); 17.770 in Spanish at 1548 (Lukas, NY).

SRI LANKA - SLBC in English from 1745-1815 on 11.800, ID every 15-minutes, but very weak w/rapid flutter (Batman, LA).

SUDAN - Omdurman, 5.039 from 0412-0439 in Arabic. Man singing in Arabic, announcements, flute music (Fravel, WV).

SWAZILAND - TWR, 4.760 from 0300 s/on in English w/ID, then woman into local language (Hickerson, AR); 11.760 in English at 0615 but very weak (Rials, LA).

SWITZERLAND - Swiss R. Int'l. on 9.725 at 0225 w/SWL program (Hunt, NC); 9.885 at 0215 w/news, "Swiss Shortwave Merry-go-Round"

(Mayo, ME); 12.035 at 2129 sked in English, into Spanish (Moran, IL); 2110 political commentary (Pastrick, PA).

SYRIA - R. Damascus, 12.085 at 2035 w/American pops, woman announcer (Hunt, NC); 2015 editorial comments in English, s/off 2059 (Mayo, ME).

TAHITI - R. Tahiti, 15.1704 at 0228 w/woman announcer, island music //11.8257 (Mayo, ME).

TOGO - Radiodiffusion Television Togolaise, 5.047 w/test tone at 0514 (Shute, FL).

TURKEY - V. of Turkey, 9.560 in English at 0330, Turkish folk music (Behrendt, NE); 2315 about friction between Greece/Turkey (Hunt, NC).

UNIDENTIFIED - 9.595 at 0658 in English, ID sounded like "Radio Tampa" (Shute, FL) Another name used by Nihon SW BC in Japan-- Ed.

9.940 w/lots of talk about Cuba 0000-0100 (Linonis, PA) La V. del CID, clandestine-- Ed.

4.830 sounded like "Radio Martina" at 0112 -- probably R. Tachira, Venezuela-- Ed.

10.040 at 1214 w/oriental music & talk (Northrup, WI). May be V. of Vietnam-- Ed.

9.590 in Spanish at 1217 (Northrup, WI).

11.720 in French at 1840 & said (in French) you are listening to the 1st test transmission from Radio Saysha(?). May be FEBA, Seychelles? (Shute, FL).

UNITED STATES - VOA on 6.020 in Russian at 0400, QRM's V. of Nicaragua (Lukas, NY).

R. Marti, 6.075 at 1100 "Buenos Dias, Cuba" opening (McDonough, PA); 1012 music program in Spanish w/1960's US songs, ID 1030 (Fravel, WV); 9.580 atop R. Australia at 1357 (Lukas, NY); 11.930 at 2130 Spanish talk, US rock (Rials, LA); 2135 pop music, Spanish (Moran, IL).

AFRTS on 15.345/15.430 at 1750, Dallas Cowboys football (Moran, IL); 11.805 at 1415 w/news (Hunt, NC).

KCBI, 11.925 at 1900-2000 w/R. Earth. From 2000 on 11.790 (Batman, LA); 2000 w/mailbag, comments, music (Hunt, NC); 1915 w/country western, US news, ID (Hickerson, AR); 1807 w/news, religious program (Pastrick, PA).

KGEL, 15.280 at 2130 English religious program to Latin America (Gardner, MD); 1833-1910 music, info about Mexican earthquake in Spanish & English (Johnson, NE).

WYFR 11.930 at 1830 religious program (Rials, LA); 1815 on 15.365 requesting reports (Moran, IL); 15.440 at 2152 ID, music (Aldrich, IA); 21.525 tape running backwards before 2145 s/on & ID in English to W. Africa (Moran, IL).

USSR - R. Moscow, 7.320 at 0100 in English, also 7.195 at 2246, 11.820 at 2128 (Lukas, NY); 13.665 at 2120 "heavy metal" from Estonian rock group & commentary by kids (Aldrich, IA); World Service English via Havana on 9.600 from 1100-1330, 11.840 1330-2100; N. American service 2200-0300 on 7.115 via Havana & 6.170 which picks up World Service again after 0300 (Batman, LA).

R. Minsk in Russian or Byelorussian on 7.210 0530 to past 0600 (Batman, LA).

R. Station Peace & Progress on 7.240 in Spanish, 0300-0400 (Batman, LA).

R. Mayak, via Havana, 4.765 at 0530 (Linonis, PA).

URUGUAY - La Radio, 6.036 at 1045 in Spanish (Lingenfield, PA).

UZBEK SSR - R. Tashkent, 7.340 at 1220 in English (Lingenfield, PA).

VATICAN - Vatican R., 6.015 at 0050 w/talk about opera singer John McCormick (Hunt, NC); 6.015/9.605/11.840 0050-0110 (Batman, LA); 15.405 at 1400 in Spanish; also 11.760 at 2045 in English & 11.700 same time (Lukas, NY).

VENEZUELA - Ecos del Torbes, 4.980 at 0300 in Spanish w/Woodpecker QRM (McDonough, PA); Clear at 0300 (Linonis, PA).

R. Rumbos, Caracas, powerhouse signals on 9.660 at 0330-0400 in Spanish. Frequent ID, music "noticias" (Linonis, PA).

YVTO time signals, weak behind Havana on 6.100 at 0430 (Griffith, CO).

R. Mara, 3.275 from 0416 music program in Spanish, US top 40 (Fravel, WV).

VIETNAM - V. of Vietnam, 15.010 at 1330 w/news in English; 1358 s/off (Mayo, ME).

WEST GERMANY - V. of Germany at 0523 on 6.120 w/press review, soccer news (Lyster, BC); 9.765 at 2137 w/talk about German composers (Pastrick, PA); 11.810 in English at 1930 (Lukas, NY); English to N. America: 0100-0150 on 6.040, 6.085, 6.145, 9.545, 9.565, 11.785; to WCNA 0500-0550 on 5.960, 6.120, 6.130, 9.545, 9.690, 11.705 (Batman, LA).

R. Free Europe, 15.145 at 1110. No positive ID. Sounded like Polish (McDonough, PA).

AFRTS Munich VOA transmitter on 15.265 at 2035 (Lukas, NY).

ZAMBIA - R. Zambia, 4.910 in English at 2350, ID (Morgan, ME).

MISSING



NAME: Antonella Mattina DOB: 6/18/72. AGE: 13. EYES: Brown HAIR: Brown HEIGHT 5'. WEIGHT: 90 lbs. DATE MISSING: 7/16/84. LAST SEEN: Flushing, Queens, NY

If you can assist in identifying a child or if you are one of these missing children, call Kid Watch, TOLL FREE HOTLINE (800)-KID-WATCH

Shortwave Listeners Need

The Shortwave Guide

It's all shortwave! Frequencies, programs, equipment reviews & more. Send for a sample copy today. \$1 covers postage & handling in the US and Canada.

Miller Publishing
P.O. Box 691
Thorndale, PA 19372

CALL TOLL FREE FOR QUOTES



Kenwood Receiver Special Deals!

R600 \$289 R1000 \$389 R2000 \$449

ICOM R71A World Class Receiver \$629

HEIL SS-2 Amplified Speaker \$48⁹⁵

EAVESDROPPER Antenna \$54⁹⁵

We deal in receivers and transceivers for all applications.

VISA/MASTER CARD
FREE SHIPPING
ON MOST RIGS FOR CASH!



S.A.S.E. FOR OUR
"BENCH-TESTED"
USED EQUIPMENT LISTING

MON-FRI 9 AM - 6 PM CENTRAL TIME
SATURDAY 9 AM - 5 PM

4124 West Broadway, Robbinsdale, MN 55422 (Mpls./St. Paul)

CIRCLE 1 ON READER SERVICE CARD

A tip o' the headphones to: Eric Gardner, Cambridge, MD; Ted Moran, Chicago, IL; Billy Hunt, Durham, NC; John Miller, Thomasville, GA; Hank Lukas, Plainville, NY; Alex Batman, Baton Rouge, LA; Herb Harnish, Ft. Wayne, IN; Patrick M. Griffith, Denver, CO; Jeff Leach, Omaha, NE; Gary C. Hickerson, Ft. Smith, AR; Sheryl Paszkiwicz, Manitowoc, WI; Alan J. Marhofke, Waukesha, WI; Gene Rials, Baker, LA; James Morgan, Bangor, ME; Stanley D. Mayo, Yarmouth, ME; Mark Northrup, Milwaukee, WI; Larry R. Fravel, Clarkesburg, WV; Bob Tarte, Grand Rapids, MI; Michelle Shute, Pensacola, FL; Steven Behrendt, Lincoln, NE; David E. Salmi, Maynard, MA; Stuart Lyster, Keremeos, BC; Robert Pastrick, Conway, PA; Darrell Lingenfield III, Chambersburg, PA; Tom Aldrich, Souix Center, IA; Mike Chinakos, Camus, WA; Patrick McDonough, Pittsburgh, PA; Steven Johnson, Omaha, NE; Ejaz U. Imami, Skokie, IL; Bryan Probst, Misslbrook, AL; John A. Linonis Jr., West Middlesex, PA; and Philip A. Lupi, Safety Harbor, FL.

Til next month, good listening!



COMMUNICATIONS SHOP

Advertising Rates: SCAN members and POP'COMM subscribers are entitled to one FREE 30-word, non-commercial classified ad per year. Enclose subscription name label with ad copy. For those people not in the previously mentioned groups, non-commercial ads are 30 cents per word, including abbreviations and addresses; minimum charge \$6.00 per issue. Ads from firms offering commercial products or services are \$1.00 per word; minimum charge \$20.00 per issue. Leading key words set in all caps at no additional charge. All ads must be prepaid in full at time of insertion; a 5% discount is offered for prepaid 6 time insertions. All ads must be typewritten double spaced.

Approval: All ad copy is subject to Publisher's approval and may be modified to eliminate references to equipment and practices which are either illegal or otherwise not within the spirit or coverage scope of the magazine.

Closing Date: The 10th day in the third month preceding date of publication. Because the advertisers and equipment contained in Communications Shop have not been investigated, the Publisher of Popular Communications cannot vouch for the merchandise listed therein. Direct all correspondence and ad copy to: PC Communications Shop, 76 N. Broadway, Hicksville, NY 11801.

ELECTRONIC SPYING is the name of the game. It's also the title of a startling book which reveals the closely guarded methods & equipment used by professionals & amateurs who eavesdrop on homes & businesses with (sometimes) legal and (usually) illegal bugs & wiretaps. Written in non-technical language everyone can easily understand. **ELECTRONIC SPYING** has photos & illustrations clearly revealing exactly how they do it & where they get the equipment (much of it inexpensive & easily available). Leaves nothing to the imagination! Latest techniques covered & offers an in-depth wealth of information on the ever increasing electronic invasion unavailable from any other source. This book is used by law enforcement agencies as a reference manual. Only \$7.95 (plus \$1.00 postage) per copy from CRB Research, P.O. Box 56, Commack, N.Y. 11725.

SCANNER OPERATORS! Are you registered? Be assigned your own personal monitoring ID letters inscribed on beautiful 2-color bordered certificate. Thousands already registered! Only \$5, ppd. from CRB Research, Box 56PC, Commack, NY 11725.

WORLD'S MOST UNUSUAL Communications Books! A large selection of outstanding titles covering scanners, "confidential" frequency registries, bugging, wiretapping, electronic surveillance, covert communications, computers, espionage, monitoring, and more! New titles being added constantly! Ask for our large new FREE catalog, CRB Research, Box 56-PC, Commack, NY 11725.

NEW! TOP SECRET REGISTRY OF U.S. GOV'T FREQUENCIES by Tom Kneitel. Yes, it's finally here! The NEW 5th Edition is now 168 pages BIG in large 8 1/2" x 11" format (same page size as POP'COMM). Latest federal scanner frequency listings for FBI, FCC, Border Patrol, ATF, Immigration, Secret Service, CIA, Customs, Coast Guard, Armed Forces, and much more. Tens of thousands of call signs, frequencies, locations. The ultimate scanner directory also reveals many HF listings plus complete historic roster of all federal land stations authorized in 1923 (60 years ago)! New 5th Edition is \$14.95 postpaid by Book Rate Mail, or add \$2 if First Class Mailing wanted. Order your copy now! CRB Research, P.O. Box 56, Commack, NY 11725.

SIDE BAND OPERATORS! Join the oldest/largest network of 27 MHz SSB operators. Now more than 100,000 strong! Send self-addressed stamped long (#10) envelope for FREE details and application (no obligation). SSB Network, P.O. Box 908, Smithtown, NY 11787.

CABLE CONVERTERS TO SCRAMBLERS. Lowest price. Dealer inquiries accepted. Quantity discounts. Free catalog. P.G. Video Corp., 61 Gatchell St., Dept. PC, Buffalo, NY 14212.

COMPUTER PROGRAMS for Commodore 64. Menu driven providing logs for BCL/SWL. Update formats, QSL records, other. Disk or tape. Screen and/or printer. Send SASE for more info & sample printout. Manucy, P.O. Box 5624, Baltimore, MD 21210.

WANTED: CASH PAID FOR USED SPEED (TRAFFIC) RADAR EQUIPMENT. Write or call: Brian R. Esterman, P.O. Box 8141, Northfield, IL 60093. (312) 251-8901.

NEW! AIR-SCAN 4th Edition by Tom Kneitel. At last, a complete directory of aero communications stations/frequencies! Now in gigantic 120 page large-size (8 1/2 x 11) format containing 40,000 listings (USA/Canada/Mexico/PR), including worldwide HF (2-30 MHz) freq. guide. In addition to 118-136 MHz VHF aero band scanner listings, also covers 30-50, 138-174, & 400+ MHz aero freqs. never before published. AIR-SCAN covers civilian/military airports, also "unlisted" airports not open to public, FAA freqs. FSS, towers, Unicom, airport security and operations freqs. new airfone air/ground telephone freqs. "hidden" business-band aero stations. military, traffic choppers, aero weather, federal agency aero, flight schools, aircraft mfrs., crop dusters, air ambulances and much more throughout USA. Largest directory of all-band aero radio communications ever published. Includes how-to text on aero monitoring and equipment selection. Only \$10.95 + \$1 shipping to USA/Canada/APO/FPO. Order from CRB Research, P.O. Box 56, Commack, NY 11725.

CLANDESTINE CONFIDENTIAL keeps you up to date on the latest in clandestine broadcasting. 6 issues per year \$10 in the U.S., \$13 foreign. G.L. Dexter, RR4 Box 110, Lake Geneva, WI 53147.

JOIN A RADIO listening club. Complete information on major North American clubs for 25¢ and SASE. Association of North American Radio Clubs, 1500 Bunbury Drive, Whittier, CA 90601.

NORTH AMERICAN RADIO-TV STATION GUIDE by Vane Jones. Brand new 15th Edition! Thick 226-page book listing all US/Canadian/Mexican/West Indies AM/FM/TV broadcasters according to location/frequency/callsign, plus TV network affiliation, AM station day/night power, schedule data, etc. Painstakingly complete, accurate, up-to-date. The ultimate broadcast station directory. Only \$9.95 (plus \$1 postage) from CRB Research, P.O. Box 56, Commack, NY 11725.

LANDMOBILE AND MARINE RADIO TECHNICAL HANDBOOK has been written for current and prospective two-way radio technicians, operators, and engineers. It can be used as a radiocommunications textbook for home study or classroom. Two-way fundamentals, circuit details, maintenance and installation data, test equipment types and practical usage, two-way services and frequencies, transmission characteristics and classifications, solid-state fundamentals as related to transmission circuits, modulation systems, digital and microprocessor circuits, test equipment types and usage, antenna systems, landmobile systems and circuits, repeater, trunked, and cellular radio, marine radiotelephone and radiotelegraph equipment, direction finders and loran, marine radar and FCC licensing information. 575 page SAMS book \$24.95 + \$2 P&H. Ed Noll, Box 75, Chalfont, PA 18914.

CABLE TV CONVERTERS & EQUIPMENT. Plans and parts. Build or buy. FREE information. C&D Electronics, P.O. Box 1402, Dept. PC, Hope, Arkansas 71801.

EARN \$800+ WEEK! Get your "F.C.C. General Radiotelephone License."—Fast, inexpensive! Electronics Home Study, "Free" details. Command, D-216, Box 2223, San Francisco 94126.

THE MODEL WAT-50 MINIATURE FM TRANSMITTER



The model WAT-50 MINIATURE FM TRANSMITTER uses a 4-stage circuit NOT to be confused with just a simple wireless microphone. Up to 1 mile range. So sensitive, it can pick-up a person whispering 50 feet away! Completely tuneable. Use with any FM radio. Complete kit only \$29.98. Tax included. FREE SHIPPING.

THE WIRELESS TELEPHONE TRANSMITTER MODEL WTT-20

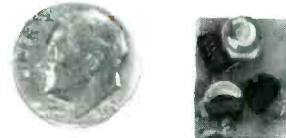

The WIRELESS TELEPHONE TRANSMITTER model WTT-20 is only about the size of a dime, yet it transmits both sides of a telephone conversation with crystal clarity! Completely automatic operation. Uses power from the telephone line itself - never needs a battery! Up to 1/4 mile range. Completely tuneable. Use with any FM radio. Complete kit only \$29.98. Tax included. FREE SHIPPING.

To order, send only \$29.98 per kit in check or money order. COD and credit card orders welcome by mail or telephone. VISA and MASTERCARD accepted. COD orders allow a \$4.00 charge on your total order. All orders shipped by US mail within 48 hours. Personal checks allow 14 days.

DECO INDUSTRIES
BOX 607, BEDFORD HILLS, NY 10507
(914) 241-2827

The above devices are available in the US only as electronic kits. Soldering required.

CIRCLE 128 ON READER SERVICE CARD

Coming Soon In POPULAR COMMUNICATIONS

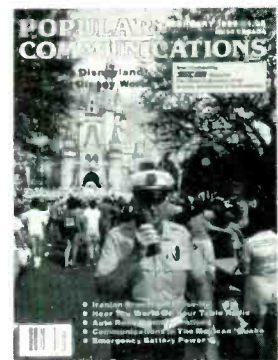

- Broadcasting's Greatest EKKO
- Flying High With The VHF Aero Band
- Handy Ute Finder Chart
- Spring '86 English Language Broadcast Schedules
- Exclusive Photos: World's Most Powerful Radio Station
- Clandestine Broadcaster Update

FREE CB MODIFICATIONS CATALOG! Frequencies, sliders, FM, linears, kits, books, repairs, high-performance accessories. CBCI, Box 31500PC, Phoenix, AZ 85046 (602) 996-8700.

COMMUNICATIONS PLANS, BOOKS, KITS! AM/FM broadcasting (licensed/unlicensed), 1750 Meter transceivers, ham/CB amplifiers, surveillance bugs, more. FREE catalog. PAN-COM, Box 130-P*, Paradise, CA 95969.

FCC COMMERCIAL GENERAL RADIOTELEPHONE LICENSE Correspondence Course. 60 individual lessons for \$89.50. Payment plan. Results guaranteed! Details free. AMERICAN TECHNICAL INSTITUTE, Box 201, Cedar Mountain, NC 28718.

NATIONAL ORGANIZATION OF SCANNER OWNERS: Non-Profit! Protecting rights of scanner owners. Newsletters, UNBIASED test results, NO Advertising! FREE Nation-wide frequency directory! Membership: \$9.00/year. NOSO, Box 3047-PC, Greenville, NC 27836-3047.

ANOTHER DAY with an empty mailbox? Improve your QSL returns with *Secrets of Successful QSL'ing* by Gerry L. Dexter. This complete guide to reception reporting and QSL'ing SWBC, Utility, Ham and medium wave stations covers everything from basics to advanced techniques. Just \$9.95 plus \$1 s/h, \$2 s/h foreign orders, U.S. funds only. Order now from Tiare Publications, P.O. Box 493, Lake Geneva, WI 53147.

FOR SALE: Kantronics "The Interface" for CW, RTTY and ASCII, \$100.00. Kantronics Hamsoft for TI 99, \$70.00. Heathkit Frequency Counter, Model IM2410, assembled, \$110.00. All original cartons and instructions. Mark, 414-781-6293.

REALISTIC DX-302 (unused) \$250.00. DX-300 (excellent) \$150.00. SONY 2002 (New) \$175.00. May trade for programmable scanners. Larry, 11664 W. Saratoga Ave., Morrison, CO 80465, 303-426-1133.

45CH HX-1200 HAND-HELD \$249.50. R-7000 \$799.50, MX-7000 \$399.50, MX-5000 \$339.50, R-71/A \$649.50, DX-1000 \$369.50, much more!! Free testing before shipping!! 31 page 1986 picture catalog \$1.00 (refundable). Galaxy Electronics, Box-1202, 67 Eber Ave., Akron, Ohio 44309. (216-376-2402) 9-5pm EST.

ANTIQUARIAN RADIOS, SCHEMATICS, tubes & literature. Send SASE to VRS(PC), 376 Cilley Rd., Manchester, NH 03103 for large list.

STUDY BROADCASTING IN ENGLAND THIS SUMMER! College credit course in British Broadcasting taught in London, July 11-August 7. Contact: Dr. Michael Biel, Morehead State University, UPO893, Morehead, KY 40351.

POWERFUL MICRO-MINIATURE FM TRANSMITTERS. Monitor remote sites, conversations, telephone systems, security. Free catalogue. Skywave Radio, Box Q-1, 943 Boblett, Blaine, Washington 98230.

MODIFICATION KITS: CR-2021/DX-400, ICF-6500, R-70/71A, others. Sony/Panasonic radios, filters, accessories. Stamp for catalogue. RADIO PLUS+, 3635 Chastain Way, Pensacola, FL 32503.

BEARCAT FOUR-SIX SCANNER with carrying case, rubber and telescoping antennas, AC adaptor/charger. \$85. check or money order. A. Volpe, P.O. Box 239, Worcester, PA 19490.

VHF TWO-WAY RADIO, 25-watt crystal-controlled high-band VHF with mike, mounting bracket, cables, \$100. Antenna for this radio, \$20. Realistic four-channel VHF-hi mobile scanner, \$50. Five-watt six-channel Realistic CB walkie-talkie, almost new with case and original box, \$50. Payments by bank check or money order only. R.R. Wise, 8977 Mariner Drive, Rockford, IL 61111.

CRYSTALS FOR SALE used in Realistic and Regency scanners: 155.37, 151.430, 161.715, 129.900, 119.55, 129.85 and 121.15 MHz. \$3 each, send bank check or money order only. Keith Tonn, P.O. Box 103, Coleman, WI 54112.

BEARCAT 100 SCANNER, carton, case, charger, nicads, antenna, mint condition, \$200. Panasonic RF-4800 shortwave receiver, 10-band, \$300. Paul A. Baillon, 330 Salem Church Road, St. Paul, MN 55118.

ARMY FIELD RADIOS: Factory mint PRC-9 Backpack Radio, transmits-receives 28-39 MHz FM continuous tuning: \$52.50 apiece, \$77.50 with good condition battery box, antenna, handset. CPRC-26 Infantry Manpack Radio, compact, transmits-receives 46-54 MHz FM, with battery box, antenna, crystal, handset: \$22.50 apiece, \$42.50/pair. PRC-510 Backpack Radio (Canadian version of American PRC-10), transmits-receives 38-55 MHz FM continuous tuning, with battery box, antenna, handset: \$39.50 apiece, \$77.50/pair. R-390A Communications Receiver, \$195 good condition. Factory mint R-108 Vehicle/Field Receiver, 20-28 MHz FM: \$27.50. 45 Day Replacement Guarantee. Add \$9.50 shipping-handling. Baytronics, Dept. PC, Box 591, Sandusky, OH 44870.

BEARCAT 300 SCANNER, 50-channel programmable and preprogrammed scanner, good condition with manual, \$225 or best offer. Send certified check or money order, will ship UPS. P.J. Mooney, 5301 Kentucky Ave. N., Minneapolis, MN 55428.

BEARCAT 100 SCANNER, programmable handheld, excellent condition. Includes original carton, two leather carrying cases, new nicad batteries, AC charger/adaptor and antenna, \$185. Will ship postpaid and insured upon receipt of certified check or money order. John Shinkowsky, 519 East Center Street, Mahoney City, PA 17948.

MIDLAND POCKET SCANNER, four channels with rubber and telescopic antennas, AC and DC power supplies/chargers, case, nicads and many crystals. Excellent condition, \$75 or best offer. Bearcat 250, not working, best offer gets it. Kraig D. Pritts, 3421 Oneida Street, Chadwicks, NY 13319, 315-737-7370.

BEARCAT CP-2100 COMPUSCAN, 200 channel scanner for use with IBM-PC, Atari 800XL, Apple IIe, Commodore 64. Requires disk drive. Several available. Mike Scholl, 10330 W. Roosevelt Road, #119, Westchester, IL 60153, 312-450-1212.

BEARCAT FOUR-SIX SCANNER, \$165. Crystals for the same scanner, \$2 each. Lee W. Johnson, 206 Vernon Ave., Glen Burnie, MD 21061.

BEARCAT 100 SCANNER, 16-channel programmable unit, only three months old and hardly used. Complete with manual, carrying case, rechargeable batteries, charger/adaptor and earplug. \$190. Kurt Chambers, 4616 W. Penn Highway, Easton, PA 18042.

REALISTIC DX-100 shortwave receiver. Covers 520 kHz to 30 MHz, good condition, includes AC/DC power cords, telescoping antenna, manual. Make offer. Realistic PRO-25 pocket scanner, one year old, good condition with rubber duck and telescoping antenna, four nicad batteries, crystals. Covers VHF hi-lo-air and UHF-T. Make offer. Scott Glicker, P.O. Box 17255, Plantation, FL 33318.

OKLAHOMA SCAN MEMBERS wanted for correspondence. I need law enforcement frequencies and ten-codes, especially OHP high-bands. I would appreciate any help and hope I can be of help to you. James Reagan, 1415 McKinley Ave., Norman, OK 73069.

OAKLAND, CALIFORNIA AREA scanner owners wanted for correspondence on antennas and other information on the Bearcat 20/20 scanner. Also would like to contact scanner owners in Hayward and Castro Valley. Harold Ungar, 415-581-3325.

CORDLESS PHONE OWNERS wanted for correspondence. Send frequency and other information about your cordless telephone. Wayne & Wanda Ramsey, Box 280, Talihina, OK 74571.

AD INDEX

| | |
|----------------------------------|------------|
| AMC Sales Co. | 59 |
| ARRL | 45 |
| All Electronics | 65 |
| Barry Electronics | 38 |
| CBC International | 38 |
| CRB Research | 26, 34 |
| Capri Electronics | 53 |
| Communications Electronics | 7 |
| Computer Trader | 38 |
| Computronix | 38 |
| Copper Electronics | 13, 57 |
| DNE, Inc. | 26 |
| Deco Industries | 75 |
| Dick Smith Electronics | 41 |
| EGE, Inc. | 9 |
| Electronic Equip. Bank .. | 14, 15, 73 |
| Gilfer Shortwave | 65 |
| Grove Enterprises | 17 |
| Ham Station | 45 |
| ICOM America, Inc. | Cov.IV |
| Jensen Tools | 38 |
| JoGunn Ent. | 34 |
| Kenwood | Cov.II |
| MFJ Enterprises, Inc. | 23 |
| Madison Electronics | 4 |
| Mastervoice, Ltd. | 1 |
| Meshna, Inc. | 65 |
| Microlog Corp. | 17 |
| Palomar Engineers | 42 |
| Radio West | 26 |
| Regency Electronics | 21 |
| SATMAN | 39 |
| Scanner World, USA. | 2 |
| Shortwave Guide | 74 |
| Signal Engineering | 31 |
| Spectronics | 61 |
| TNT Radio Sales, Inc. | 74 |
| Universal SW Radio | 57 |
| Van Valzah Co. | 41 |
| Yaesu Electronics | Cov.III |

Reach this dynamic audience with your advertising message, contact Herb Pressman at (516) 681-2922.

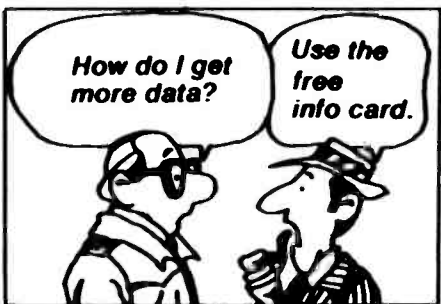



Yaesu has serious listeners for the serious listener

Yaesu's serious about giving you better ways to tune in the world around you.

And whether it's for local action or worldwide DX, you'll find our VHF/UHF and HF receivers are the superior match for all your listening needs.

The FRG-9600. A premium VHF/UHF scanning communications receiver. The 9600 is no typical scanner. And it's easy to see why.

You won't miss any local action with continuous coverage from 60 to 905 MHz.

You have more operating modes to listen in on: upper or lower sideband, CW, AM wide or narrow, and FM wide or narrow.

You can even watch television programs by plugging in a video monitor into the optional video output.

Scan in steps of 5, 10, 12½, 25 and 100 KHz. Store any frequency and

CIRCLE 19 ON READER SERVICE CARD

related operating mode into any of the 99 memories. Scan the memories. Or in between them. Or simply "dial up" any frequency with the frequency entry pad.

Plus there's more, including a 24-hour clock, multiplexed output, fluorescent readout, signal strength graph, and an AC power adapter.

The FRG-8800 HF communications receiver. A better way to listen to the world. If you want a complete communications package, the FRG-8800 is just right for you.

You get continuous worldwide coverage from 150 KHz to 30 MHz. And local coverage from 118 to 174 MHz with an optional VHF converter.

Listen in on any mode: upper and lower sideband, CW, AM wide or narrow, and FM.

Store frequencies and operating modes into any of the twelve channels for instant recall.

Scan the airwaves with a number of programmable scanning functions.

Plus you get keyboard frequency entry. An LCD display for easy readout. A SINPO signal graph. Computer interface capability for advanced listening functions. Two 24 hour clocks. Recording functions. And much more to make your listening station complete.

Listen in. When you want more from your VHF/UHF or HF receivers, just look to Yaesu. We take your listening seriously.

YAESU

Yaesu Electronics Corporation
6851 Walthall Way, Paramount, CA 90723
(213) 633-4007

Yaesu Cincinnati Service Center
9070 Gold Park Drive, Hamilton, OH 45011
(513) 874-3100



Dealer inquiries invited.

Prices and specifications subject to change without notice.
FRG-9600 SSB coverage: 60 to 460 MHz.

ICOM 25-1000MHz Plus!

IC-R7000



ICOM's commercial quality scanning receiver...Top quality at a gem of a price.

ICOM introduces the IC-R7000 advanced technology 25-2000MHz* continuous coverage communications receiver. With 99 owner programmable memories, the IC-R7000 covers low band, aircraft, marine, business, FM broadcast, amateur radio, emergency services, government and television bands.

Keyboard Entry. For simplified operation and quick

tuning, the IC-R7000 features direct keyboard entry. Precise frequencies can be selected by pushing the digit keys in sequence of the frequency or by turning the main tuning knob.

99 Memories. The IC-R7000 has 99 memories available to store your favorite frequencies, including the operating mode. Memory channels may be called up by simply pressing the Memory switch, then rotating the memory channel knob, or by direct keyboard entry.

Scanning. A sophisticated scanning system provides instant access to most used frequencies. By depressing the Auto-M switch, the

IC-R7000 automatically memorizes frequencies in use while the unit is in the scan mode. This allows you to recall frequencies that were in use.

Other Outstanding Features:

- FM wide/FM narrow/AM/upper and lower SSB modes
- Six tuning speeds: 0.1, 1.0, 5, 10, 12.5 or 25KHz
- Dual color fluorescent display with memory channel readout and dimmer switch
- Compact Size: 4-3/8"H x 11 1/4"W x 10 7/8"D
- Dial lock, noise blanker, combined S-meter and center meter

- Optional RC-12 infrared remote controller
- Optional voice synthesizer. When recording, the voice synthesizer automatically announces the scanned signal frequency.

*Specifications guaranteed from 25-1000MHz and 1260-1300MHz. No coverage from 1000-1025MHz. No additional module required for coverage to approximately 2.0GHz.

See the IC-R7000 receiver at your local authorized ICOM dealer. Also available is the IC-R71A 0.1-30MHz general coverage receiver.

ALL THIS AT A PRICE YOU'LL APPRECIATE.

CIRCLE 115 ON READER SERVICE CARD



First in Communications

ICOM America, Inc., 2380-116th Ave NE, Bellevue, WA 98004 / 3331 Towerwood Drive, Suite 307, Dallas, TX 75234

All stated specifications are approximate and subject to change without notice or obligation. All ICOM radios significantly exceed FCC regulations limiting spurious emissions. R7000985